



GRTE18S-P2312S02

GR18

CYLINDRICAL PHOTOELECTRIC SENSORS

**SICK**  
Sensor Intelligence.



Illustration may differ



### Ordering information

Type	Part no.
GRTE18S-P2312S02	1066165

Other models and accessories → [www.sick.com/GR18](http://www.sick.com/GR18)

### Detailed technical data

#### Features

<b>Functional principle</b>	Photoelectric proximity sensor
<b>Functional principle detail</b>	Energetic
<b>Dimensions (W x H x D)</b>	18 mm x 18 mm x 38.1 mm
<b>Housing design (light emission)</b>	Cylindrical
<b>Thread diameter (housing)</b>	M18 x 1
<b>Optical axis</b>	Axial
<b>Sensing range max.</b>	3 mm ... 115 mm <sup>1)</sup>
<b>Sensing range</b>	5 mm ... 100 mm <sup>1)</sup>
<b>Type of light</b>	Visible red light
<b>Light source</b>	PinPoint LED <sup>2)</sup>
<b>Light spot size (distance)</b>	Ø 8 mm (100 mm)
<b>Wave length</b>	650 nm
<b>Adjustment</b>	Potentiometer, 270°
<b>Indication</b>	
	LED green Operating indicator Static on: power on
	LED yellow Status of received light beam Static on: object present Static off: object not present

<sup>1)</sup> Object with 90% remission (based on standard white, DIN 5033).

<sup>2)</sup> Average service life: 100,000 h at T<sub>U</sub> = +25 °C.

## Mechanics/electronics

<b>Supply voltage</b>	10 V DC ... 30 V DC <sup>1)</sup>
<b>Ripple</b>	< 5 V <sub>pp</sub> <sup>2)</sup>
<b>Current consumption</b>	30 mA
<b>Switching output</b>	PNP, with time delay t <sub>off</sub> 130 ms
<b>Switching mode</b>	Light switching
<b>Signal voltage PNP HIGH/LOW</b>	V <sub>S</sub> - (≤ 3 V) / approx. 0 V
<b>Output current I<sub>max</sub></b>	≤ 100 mA <sup>3)</sup>
<b>Response time</b>	< 1,000 μs <sup>4)</sup>
<b>Switching frequency</b>	500 Hz <sup>5)</sup>
<b>Connection type</b>	Connector M12, 3-pin
<b>Circuit protection</b>	A <sup>6)</sup> B <sup>7)</sup> D <sup>8)</sup>
<b>Protection class</b>	III
<b>Special device</b>	✓
<b>Housing material</b>	Metal, Nickel-plated brass and ABS
<b>Optics material</b>	Plastic, PMMA
<b>Enclosure rating</b>	IP67
<b>Items supplied</b>	Fastening nuts (2 x)
<b>Electromagnetic compatibility (EMC)</b>	EN 60947-5-2
<b>Ambient operating temperature</b>	-25 °C ... +55 °C <sup>9)</sup>
<b>Ambient temperature, storage</b>	-40 °C ... +70 °C
<b>UL File No.</b>	NRKH.E348498 & NRKH7.E348498

<sup>1)</sup> Limit values. Operated in short-circuit protected network: max. 8 A.

<sup>2)</sup> May not exceed or fall below U<sub>v</sub> tolerances.

<sup>3)</sup> At U<sub>v</sub> > 24 V or ambient temperature > 49 °C, I<sub>A</sub> max. = 50 mA.

<sup>4)</sup> Signal transit time with resistive load.

<sup>5)</sup> With light/dark ratio 1:1.

<sup>6)</sup> A = V<sub>S</sub> connections reverse-polarity protected.

<sup>7)</sup> B = inputs and output reverse-polarity protected.

<sup>8)</sup> D = outputs overcurrent and short-circuit protected.

<sup>9)</sup> At U<sub>v</sub> <= 24V and I<sub>A</sub> < 50mA.

## Classifications

<b>eCl@ss 5.0</b>	27270903
<b>eCl@ss 5.1.4</b>	27270903
<b>eCl@ss 6.0</b>	27270903
<b>eCl@ss 6.2</b>	27270903
<b>eCl@ss 7.0</b>	27270903
<b>eCl@ss 8.0</b>	27270903
<b>eCl@ss 8.1</b>	27270903
<b>eCl@ss 9.0</b>	27270903
<b>eCl@ss 10.0</b>	27270904

<b>eCl@ss 11.0</b>	27270904
<b>eCl@ss 12.0</b>	27270903
<b>ETIM 5.0</b>	EC001821
<b>ETIM 6.0</b>	EC001821
<b>ETIM 7.0</b>	EC002719
<b>ETIM 8.0</b>	EC002719
<b>UNSPSC 16.0901</b>	39121528

### Connection type

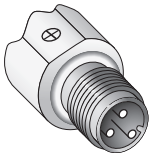

### Connection diagram

Cd-045

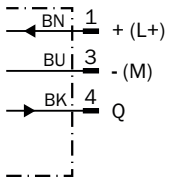

### Characteristic curve

GRTE18S, 100 mm

Operating reserve

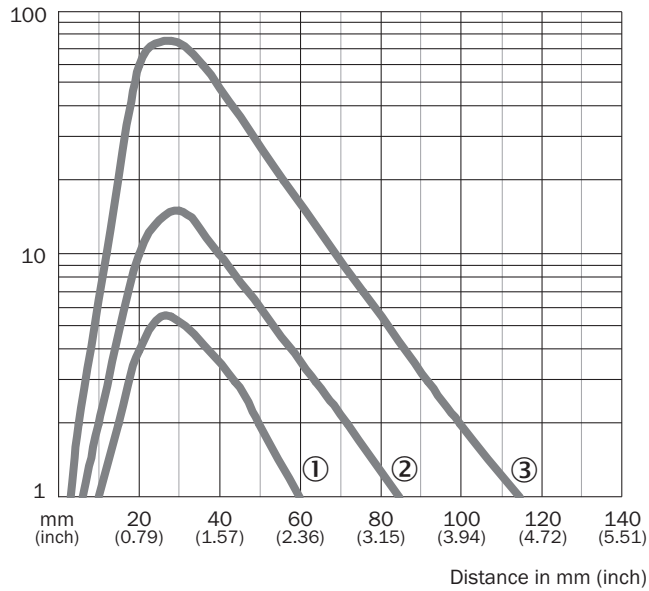

- ① Sensing range on black, 6% remission
- ② Sensing range on gray, 20 % remission
- ③ Sensing range on white, 90% remission

### Light spot size

GRTE18S, 100 mm

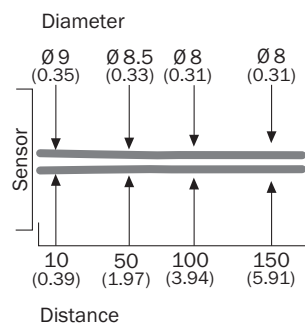

Dimensions in mm (inch)

### Sensing range diagram

GRTE18S, 100 mm

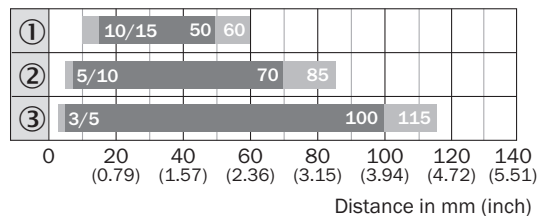

- Sensing range      ■ Sensing range max.
- ① Sensing range on black, 6% remission
- ② Sensing range on gray, 20% remission
- ③ Sensing range on white, 90% remission

### Response range

GRTE18S, 100 mm

Parallel operating range y in mm (inch)

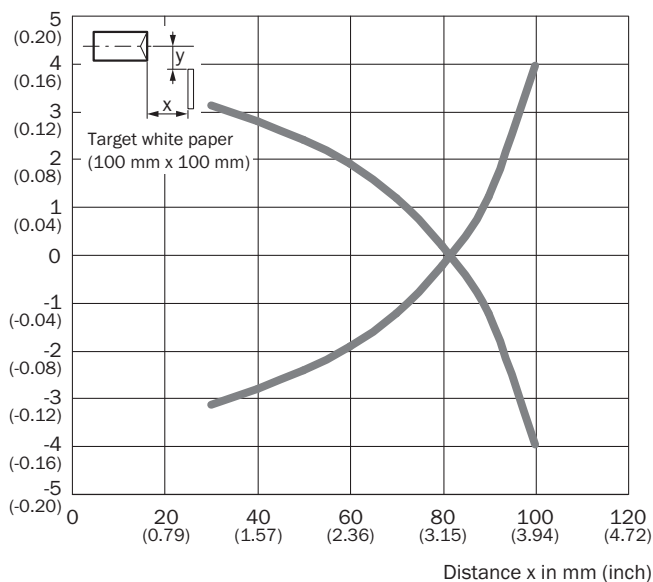

## Adjustments

GRTB18(S), GRTE18(S), Sensing range setting: Potentiometer, 270°

Sensing range

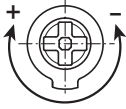

## Dimensional drawing (Dimensions in mm (inch))

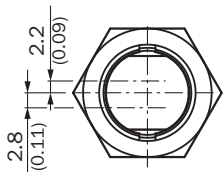
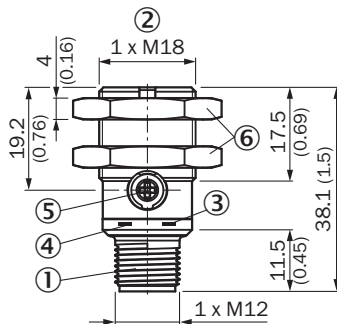

GR18S, metal, connector, straight, adjustable



- ① Connector M12, 3-pin
- ② Threaded mounting hole M18 x 1
- ③ LED indicator yellow
- ④ LED indicator green
- ⑤ Sensitivity control: potentiometer 270°
- ⑥ Fastening nuts (2x); width across 24, metal

Recommended accessories

Other models and accessories → [www.sick.com/GR18](http://www.sick.com/GR18)

	Brief description	Type	Part no.
<b>Mounting brackets and plates</b>			
	Mounting bracket for M18 sensors, steel, zinc coated, without mounting hardware	BEF-WN-M18	5308446
<b>Plug connectors and cables</b>			
	Head A: female connector, M12, 3-pin, straight, A-coded Head B: Flying leads Cable: Sensor/actuator cable, PUR, halogen-free, unshielded, 5 m	YF2A13-050UB1XLEAX	2095605



## SICK AT A GLANCE

SICK is one of the leading manufacturers of intelligent sensors and sensor solutions for industrial applications. A unique range of products and services creates the perfect basis for controlling processes securely and efficiently, protecting individuals from accidents and preventing damage to the environment.

We have extensive experience in a wide range of industries and understand their processes and requirements. With intelligent sensors, we can deliver exactly what our customers need. In application centers in Europe, Asia and North America, system solutions are tested and optimized in accordance with customer specifications. All this makes us a reliable supplier and development partner.

Comprehensive services complete our offering: SICK LifeTime Services provide support throughout the machine life cycle and ensure safety and productivity.

For us, that is “Sensor Intelligence.”

## WORLDWIDE PRESENCE:

Contacts and other locations –[www.sick.com](http://www.sick.com)