



Enclosed star-delta starters
M3P03270

Product designation

Product type designation

Electrical features

Maximum operating current ($\leq 440V$) A 50

Components

Starter enclosure standard supplied M3PA70

Contactor standard supplied BF3200A,
BF3200A,
BF2510A

Thermal relay to purchase separately RF38...

Auxiliary contact standard supplied BFX1020,
BFX1011,
BFX1011

Contact characteristics

IEC standard motor powers

230V	kW	15
400V	kW	25
440V	kW	25
500V	kW	25

Mechanical features

Weight g 3800

Ambient conditions

Operating temperature

min	°C	-25
max	°C	+60

Storage temperature

min	°C	-40
max	°C	+70

Resistance & Protection

Frontal IP degree IP65

Dimensions

STAR-DELTA STARTER, ENCLOSED STARTER, WITH START AND STOP/RESET BUTTONS.
STARTING TIME UP TO 12 SECONDS AND A MAXIMUM OF 30 OPERATIONS/HOUR, MAX IEC
OPERATING CURRENT 50A. COIL VOLTAGE 400VAC 50/60HZ

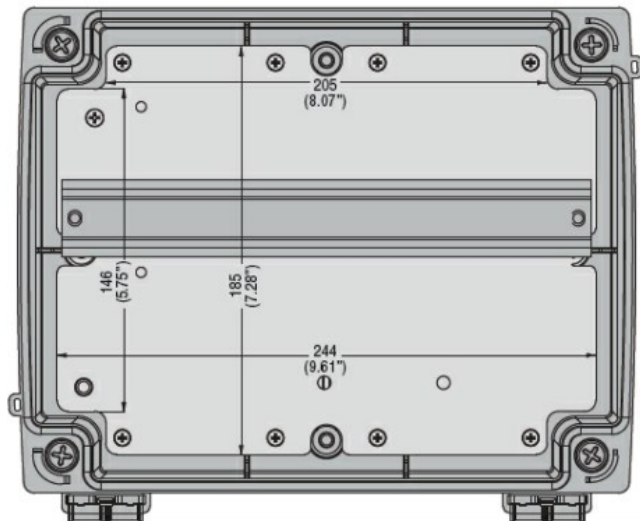
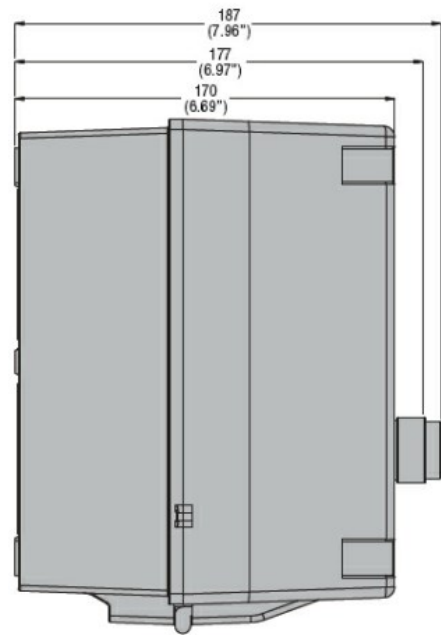
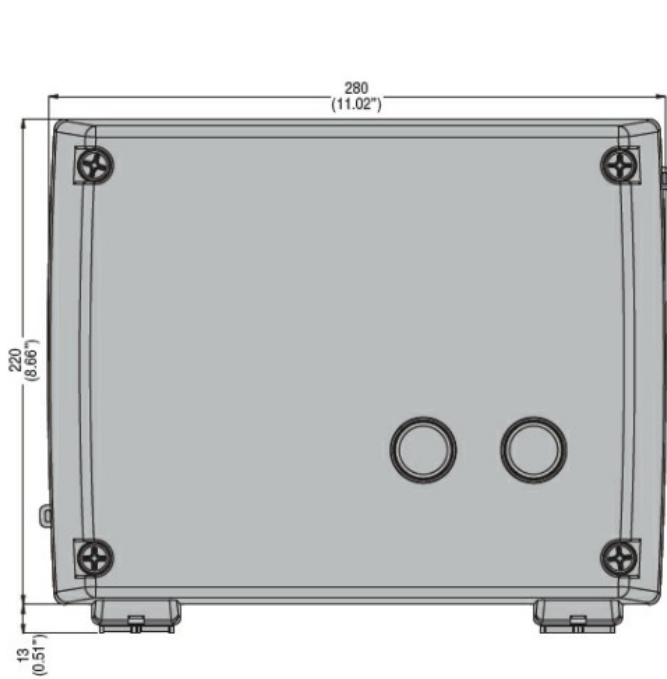

Drilling for surface fixing

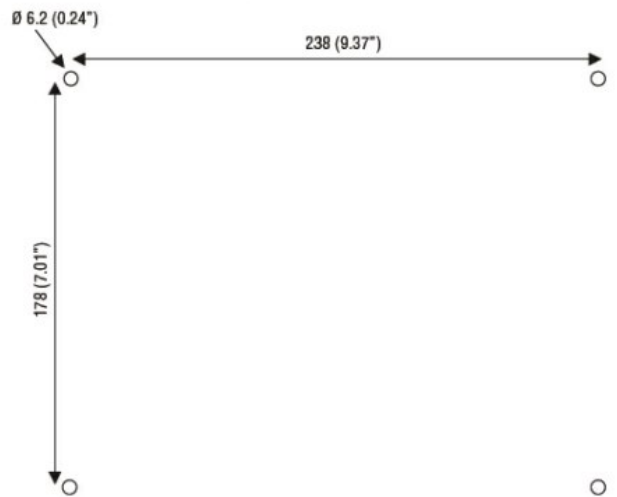

Wiring diagrams

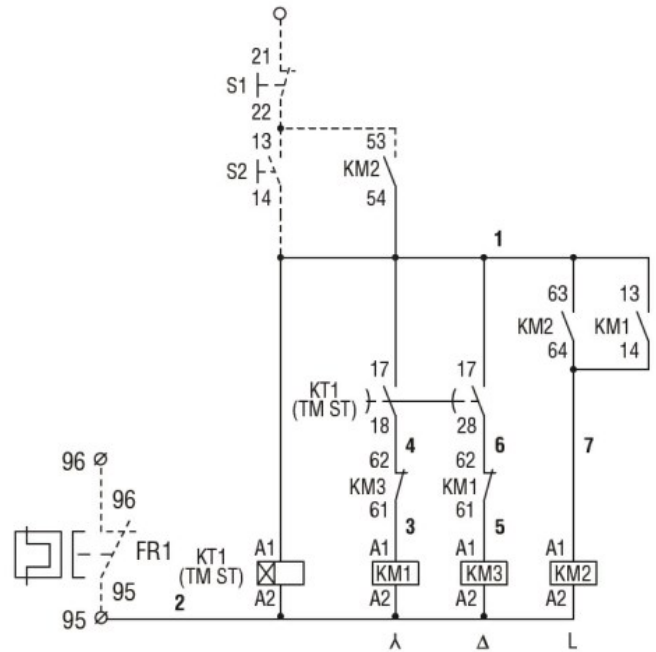
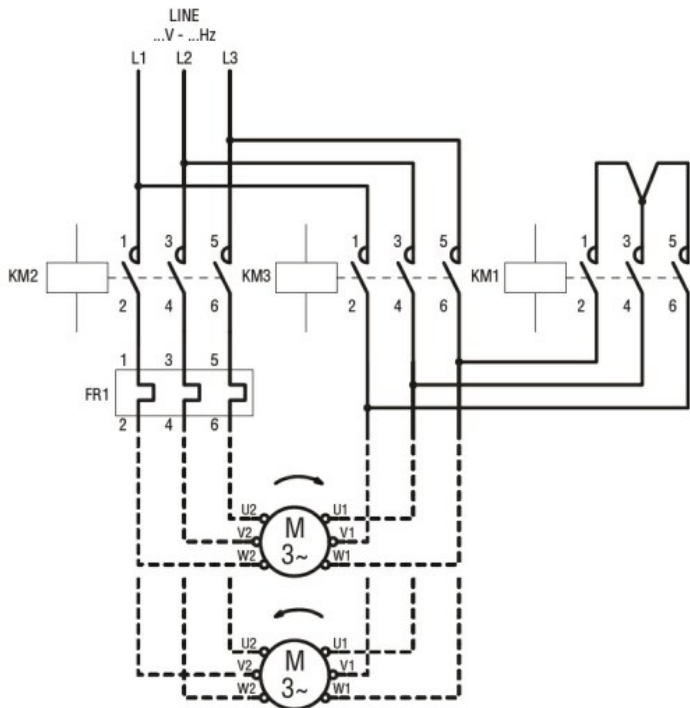

Certifications and compliance

Compliance

CSA C22.2 n° 14

for starters

IEC/EN 60947-1

IEC/EN 60947-4-1

UL508

Certificates

/

ETIM classification

ETIM 8.0

EC001037 -
Motor
starter/Motor
starter
combination