

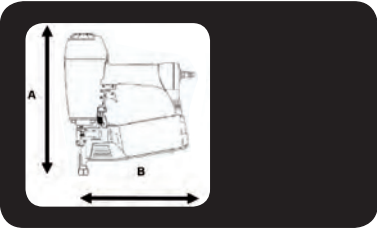

Paslode®





LCP45

		<p>A = 282 mm B = 275 mm C = 159 mm</p>
		<p>= 1.65 kg</p>

Min. 5,5 bar
Max. 8,3 bar

1,2 L (6 bar) /

Ps max. = 8,3 bar

EN 12549+EN ISO 4871

L_{wA,1s} = 103.8 dBA
L_{pA,1s} = 101.5 dBA
L_{pA,1s,1m} = 90.8 dBA

EN1996 : 1997

ISO 8662-11

Vibration = 3.1 m/s²

150 x =

Paslode Nails 0° (GN Tape)

D= max. 7,0mm
d = 2,5 - 2,8mm
L = 25 - 35 mm

+ =

	<p>Sequential trigger actuation/ Einzelauslösung/ enkelschots/ Déclenchement du tir - mode séquentiel/ Funcionamiento secuencial "en continuo"/ Gatilho de actuação sequencial/ funzionamento sequenziale (colpo a colpo)/ Enkeltskuds aftrækker/ Enkelskott/ Enkeltskudds avtrekker/ Kertalaukaisu/ Üksiklasu meetodil töötamine/ Uruchromienie spustu sekwencyjne/ Sekvenčni spoušť/ Egyes lövés (szakaszosan működtetett elsőtű billentyűvel)/ Posamezno proženje/ Kontaktirajte singl / Последовательная активация при нажатии на курок/ Sekvenčná aktivácia spúšte/ التشغيل بالتسلسل المقيد / Nuoseklusis paleidimo mechanizmas/ Sekvencialās palaišanas iedarbināšana Raðkveikjувirkjun</p>
--	---

Model: LCP45
No. 575896



0° COIL

GN-TAPE
Max. 7mm

ITW Befestigungssysteme GmbH
30966 Hemmingen, Germany



No. 617559

					<p>3x</p>
<p>No. 014748 + No. 576926</p>		<p>No. 576340</p>	<p>No. 014121</p>		

Accessories

<p>No. 505203</p>	<p>No. 151299 / No. 576216</p>
<p>Magazine insert</p>	<p>0,5 l oil / 1 l oil</p>

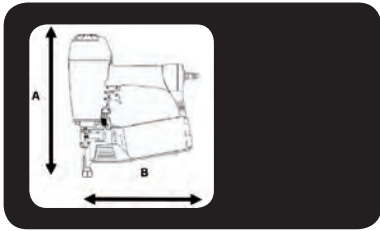

LCP45R

		<p>A = 282 mm B = 275 mm C = 159 mm</p>
		<p>= 1.9 kg</p>

Min. 5,5 bar
Max. 8,3 bar

1,2 L (6 bar) /

Ps max. = 8,3 bar

EN 12549+EN ISO 4871

L_{wA,1s} = 103.8 dBA
L_{pA,1s} = 101.5 dBA
L_{pA,1s,1m} = 90.8 dBA

EN1996 : 1997

ISO 8662-11

Vibration = 3.1 m/s²

150 x =

Paslode Nails 0° (GN Tape)

D = max. 7,0 mm
d = 2,3 - 2,5 mm
L = 22 - 35 mm

+ =

 Contact trigger actuation/ Kontaktauslösung/ repeterend schieten/ Déclenchement du tir - mode rafale/ Funcionamiento por contacto "clavo a clavo"/ Gatilho de actuação por contacto/ funcionamento a contatato/ Stødskydnings aftrækker/ Støtskjutning/ Støtspikrings avtrekker/ Kosketuslaukaisu/ Automaatmeetodil töötamine/ Uruchomienie spustu przez kontakt/ Kontaktní spoušť/ Sorozatlövés (folyamatosan behúzott elsütő billentyűvel)/ Kontaktno proženje/ Kontaktirajte pokretanje/ Контактная активация при нажатии на курок/ Kontaktná aktivácia spúšte/ التشغيل بتلامس الزر / Kontaktinis paleidimo mechanizmas/ Kontakta palaides iedarbināšana/ Snertikveikjvirkjun



Model: LCP45R
No. 575909



 **0° COIL**  **GN-TAPE**      ITW Befestigungssysteme GmbH
30366 Hemmingen, Germany





No. 617559

				 3x
No. 014748 + No. 576926		No. 014121		

Accessories

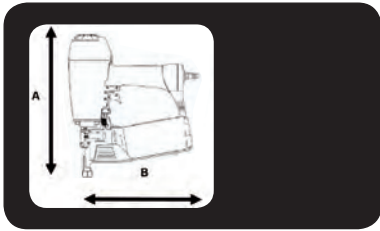
	
No. 505203	No. 151299 / No. 576216
Magazine insert	0,5 l oil / 1 l oil



LCP65

		<p>A = 330 mm B = 312 mm C = 151 mm</p>
		<p>= 2,4 kg</p>

--

<p>1,7 L (6 bar) / </p>

<p>Ps max. = 8,3 bar</p>

<p>EN 12549+EN ISO 4871</p>	<p>L_{wA,1s} = 107.6 dBA L_{pA,1s} = 106.8 dBA L_{pA,1s,1m} = 94.6 dBA</p>
-----------------------------	--

<p>EN1996 : 1997</p> <p>ISO 8662-11</p>



<p>Vibration = 4,0 m/s²</p>
--

<p>150 x = </p> <p>Paslode Nails 0° (GN Tape)</p>
--

<p>D= max. 8,0 mm d = 2,5 - 4,2 mm L = 32 - 65 mm</p>









 Sequential trigger actuation/ Einzelauslösung/ enkelschots/ Déclenchement du tir - mode séquentiel/ Funcionamiento secuencial "en continuo"/ Gatilho de actuação sequencial/ funzionamento sequenziale (colpo a colpo)/ Enkeltskuds aftrækker/ Enkelskott/ Enkeltskudds avtrekker/ Kertalaukaisu/ Uksiklasu meetodil töötamine/ Uruchromienie spustu sekwencyjne/ Sekvenční spoušť/ Egyes lövés (szakaszosan működtetett elsőtű billentyűvel)/ Posamezno proženje/ Kontaktirajte singl / Последовательная активация при нажатии на курок/ Sekvenčná aktivácia spúšte/ التشغيل بالزر التسلسلي المقيد / Nuoseklusis paleidimo mechanizmas/ Sekvenciālās palaišanas iedarbināšana Raðkveikjuvirkjun

  Contact trigger actuation/ Kontaktauslösung/ repeterend schieten/ Déclenchement du tir - mode rafale/ Funcionamiento por contacto "clavo a clavo"/ Gatilho de actuação por contacto/ funzionamento a contatto/ Stødskydnings aftrækker/ Støtskjutting/ Støtspikrings avtrekker/ Kosketuslaukaisu/ Automaatmeetodil töötamine/ Uruchromienie spustu przez kontakt/ Kontaktní spoušť/ Sorozatlövés (folyamatosan behűzött elsőtű billentyűvel)/ Kontaktno proženje/ Kontaktirajte pokretanje/ Контактная активация при нажатии на курок/ Kontaktná aktivácia spúšte/ التشغيل بتلامس الزر / Kontaktinis paleidimo mechanizmas/ Kontakta palaišanas iedarbināšana/ Snertikveikjuvirkjun

Model: LCP65 **No. 575900**

     

   **No. 575641**

					 3x
No. 014748 + No. 576926	No. 576340	No. 014121			

Accessories

		
No. 576487 Hanger	No. 505203 Magazine insert	No. 151299 / No. 576216 0,5 l oil / 1 l oil

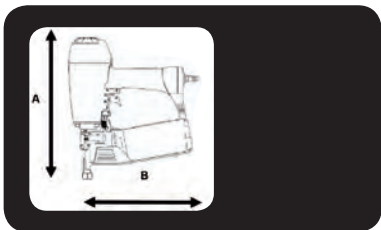

LCP45.1

		<p>A = 293 mm B = 312 mm C = 151 mm</p>
		<p>= 2.1 kg</p>

<p>Min. 5,5 bar Max. 8,3 bar</p>	<p>1,4 L (6 bar) / </p> <p>Ps max. = 8,3 bar</p>
--------------------------------------	--

<p>EN 12549+EN ISO 4871</p>	<p>L_{wA,1s} = 82.7 dBA L_{pA,1s} = 72.3 dBA L_{pA,1s,1m} = 69.7 dBA</p>
<p>EN1996 : 1997</p> <p>ISO 8662-11</p>	<p>Vibration = 4.4 m/s²</p>

<p>150 x = </p> <p>Paslode Nails 0° (GN Tape)</p>	<p>D = max. 8,0 mm d = 2,5 - 4,0 mm L = 22 - 45 mm</p>
--	--





Sequential trigger actuation/ Einzelauslösung/ enkelschots/ Déclenchement du tir - mode séquentiel/ Funcionamiento secuencial "en continuo"/ Gatilho de actuação sequencial/ funzionamento sequenziale (colpo a colpo)/ Enkeltskuds aftrækker/ Enkelskott/ Enkeltskudds avtrekker/ Kertalaukaisu/ Üksiklasu meetodil töötamine/ Uruchromienie spustu sekwencyjne/ Sekvenční spoušť/ Egyes lövés (szakaszosan működtetett elsütő billentyűvel)/ Posamezno proženje/ Kontaktirajte singl / Последовательная активация при нажатии на курок/ Sekvenčná aktivácia spúšte/ التشغيل بالزر التسلسلي المقيد / Nuoseklusis paleidimo mechanizmas/ Sekvenčiālās palaiides iedarbināšana Raðkveikjuvirkjun

Model: LCP45.1
No. 575898



0° COIL



GN-TAPE

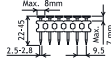

ITW Befestigungssysteme GmbH
30966 Hemmingen, Germany



No. 617559



No. 576340



No. 014121



3x

No. 014748 + No. 576926

Accessories



No. 505203

Magazine insert



No. 151299 / No. 576216

0,5 l oil / 1 l oil

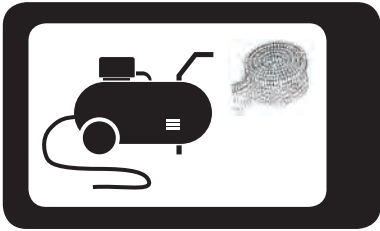

014 748

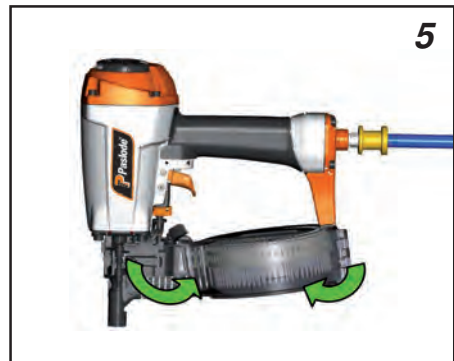
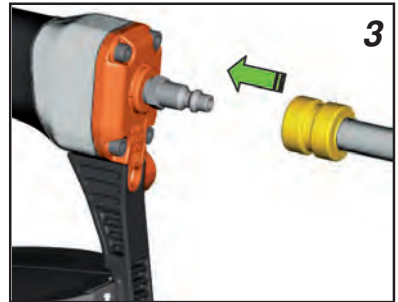
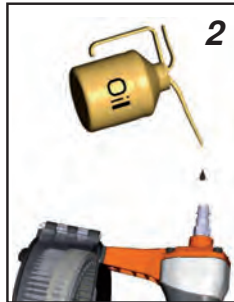
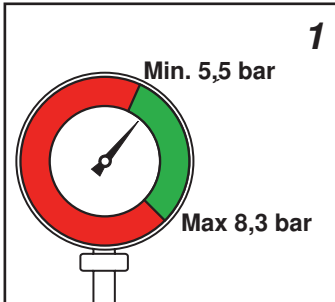

LCP45 + LCP45R:	L < 30
LCP65:	L < 50 mm

+

No. 505203

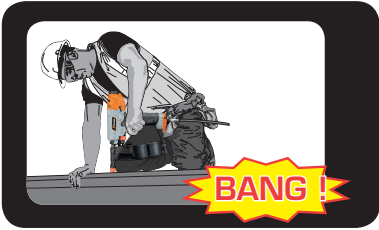

014 748

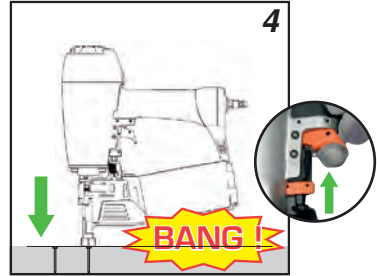
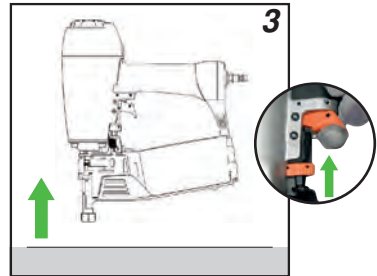
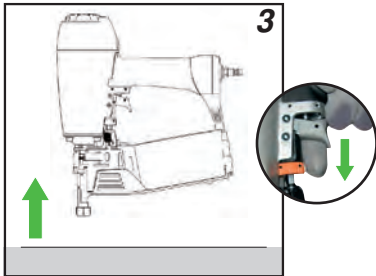
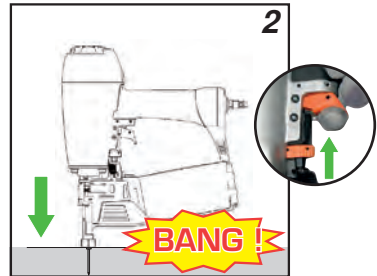
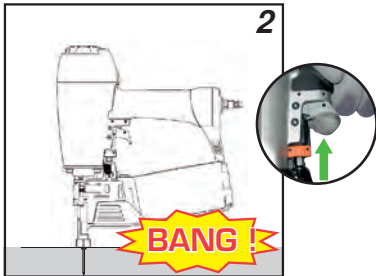
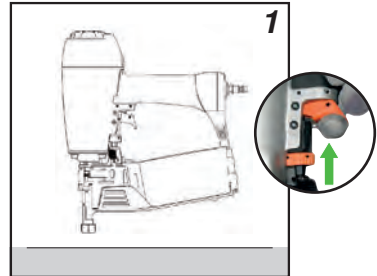
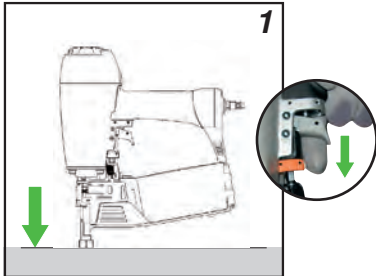

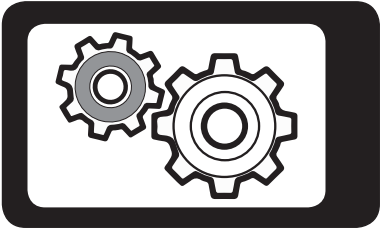

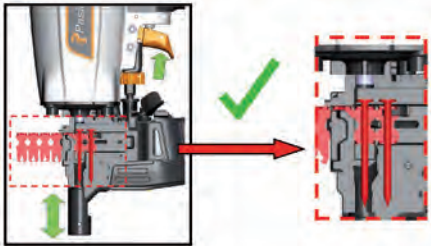
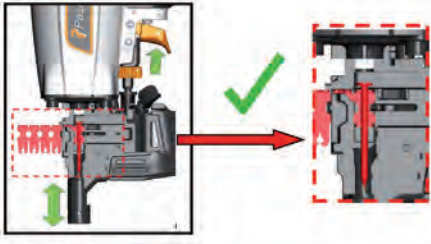
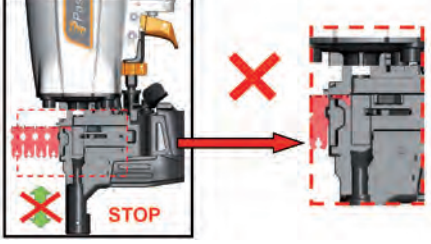
- 1. 
- 2. 
- 3. 

- 4. 
- 5. 
- 6. 

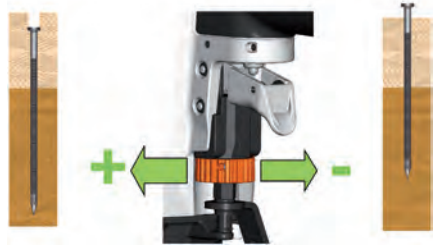

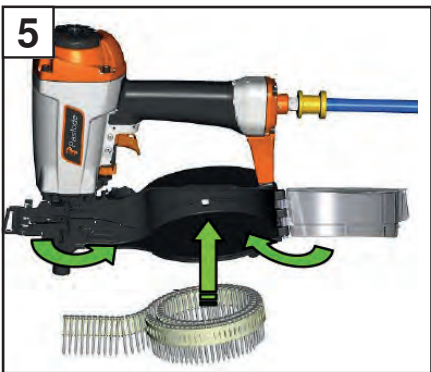
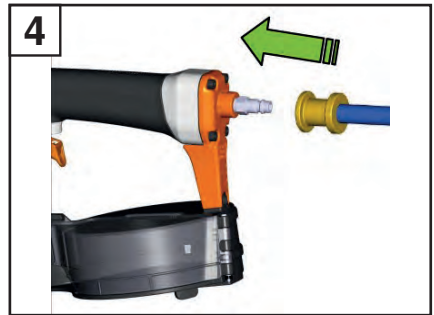
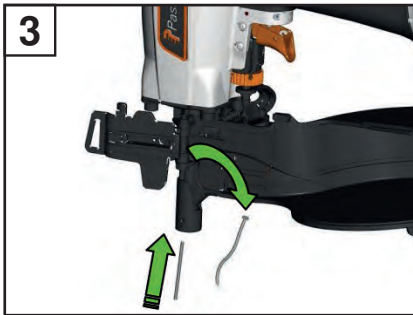
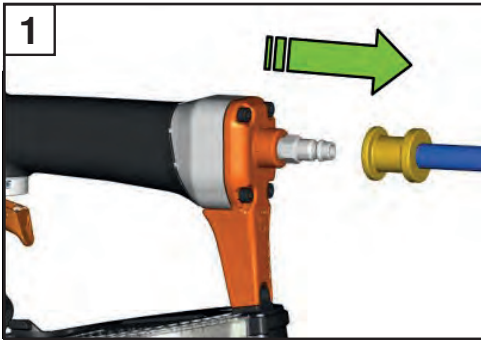

YY/WW....

YY= Year of manufacture
WW = Week of manufacture



**Resting position/ Ruheposition/ Position de repos/ Ruststand/
Posición de descanso/ Posizione di riposo/ Posição de des-
canso/ Pozycja spoczynku/ Klidová poloha/ Nyugalmi állapot/
Положение в нерабочем состоянии/ Θέση αδράνειας/ Hviles-
tilling/ Viloläge/ Hvileposisjon/ Lepoasento/ Položaj mirovanja/
Pokojuvá poloha/ Položaj mirovanja/ وضع السكون / Ramybės
padėtis/ Ooteasend/ Miera stāvoklis/ Hvíldarstaða**





ITW CONSTRUCTION PRODUCTS EUROPE
Code 575926 (05/2019)
www.spitpaslode.com