

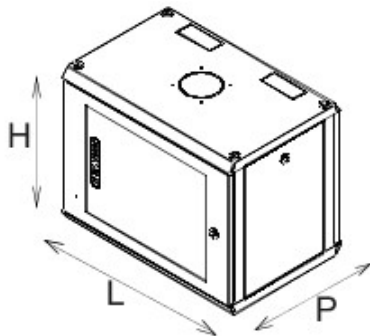

A system complete with components and accessories for LAN network cabling set-ups (both copper and optical fiber). The range includes also wall-mounting and floor-standing cabinets, from 10" and 19", with modern and innovative design, characterised by extremely easy wiring thanks to large internal volumes and lateral space. These solutions reduce installation time and allow for quick configuration at any moment, on the basis of new usage requirements.

Catégorie	19" wall-mount cabinet	Matière	Acier
Finition	Textured	Couleur	Grey (RAL 7035)
Unité de câblage	12 U	Type de porte	Reversible
No. uprights	2	Profondeur (mm)	400 mm
Dim. externes LxHxP (mm)	600x605x400	Indice de protection	IP20
Electrocod	3752		

DIMENSIONS



	H	L	P	
GW 38 406	335	600	400	6U
GW 38 407	470	600	400	9U
GW 38 408	605	600	400	12U
GW 38 409	740	600	400	15U
GW 38 418	605	600	600	12U
GW 38 419	740	600	600	15U

SYMBOLE TECHNIQUE

IP

IP20

NORMES ET HOMOLOGATIONS

CE