



KTM-LP55182P

KTM

CONTRAST SENSORS

SICK
Sensor Intelligence.



Ordering information

| Type | Part no. |
|--------------|----------|
| KTM-LP55182P | 1105836 |

Other models and accessories → www.sick.com/KTM

Illustration may differ



Detailed technical data

Features

| | |
|-----------------------------------|-----------------------------------------------------------------------------|
| Dimensions (W x H x D) | 12 mm x 31.5 mm x 21 mm |
| Sensing distance | ≤ 250 mm |
| Sensing distance tolerance | ± 30 mm |
| Housing design | Small |
| Light source | Laser, red ¹⁾ |
| Laser class | I |
| Wave length | 680 nm |
| Light emission | Long side of housing |
| Light spot size | Ø 1.8 mm (250 mm) |
| Light spot direction | Round |
| Receiving filters | None |
| Max. web speed | 10 m/s ²⁾ |
| Adjustment | Teach-in button |
| Teach-in mode | 2-point teach-in static/dynamic + proximity to mark ET: Teach-in dynamic |

¹⁾ Average service life: 100,000 h at T_J = +25 °C.

²⁾ At mark size = 1.5 mm.

Mechanics/electronics

| | |
|-----------------------|---------------------|
| Supply voltage | 10 V DC ... 30 V DC |
|-----------------------|---------------------|

¹⁾ May not exceed or fall below U_v tolerances.

²⁾ Without load.

³⁾ With light/dark ratio 1:1.

⁴⁾ Signal transit time with resistive load.

⁵⁾ At supply voltage > 24 V, I_{max} = 50 mA. I_{max} is consumption count of all Q_n.

| | |
|--------------------------------------------|---------------------------------------------------------------------------------------------------------------------|
| Ripple | $\leq 5 V_{pp}$ ¹⁾ |
| Current consumption | $< 35 \text{ mA}$ ²⁾ |
| Switching frequency | 1.5 kHz ³⁾ |
| Response time | 0.333 ms ⁴⁾ |
| Jitter | $122 \mu\text{s}$ |
| Accuracy | 0.15 mm |
| Switching output | PNP |
| Switching output (voltage) | PNP: HIGH = $U_V \leq 2 \text{ V}$ / LOW approx. 0 V |
| Switching mode | Light/dark switching |
| Output current I_{max} | 100 mA ⁵⁾ |
| Input, dynamic teach-in (ET) | PNP: Teach: $U = 10,8 \text{ V} \dots < U_V$ PNP: Run: $U < 2 \text{ V}$ or open |
| Retention time (ET) | 250 ms |
| Time delay | None |
| Connection type | Cable with M12 male connector, 4-pin, 0.3 m |
| Protection class | III |
| Circuit protection | U_V connections, reverse polarity protected Output Q short-circuit protected Interference pulse suppression |
| Enclosure rating | IP67 |
| Weight | Approx. 24 g |
| Housing material | Plastic, ABS |
| Optics material | Plastic, PMMA |
| Indication | LED indicator green: power on LED indicator, yellow: Status switching output Q |

¹⁾ May not exceed or fall below U_V tolerances.

²⁾ Without load.

³⁾ With light/dark ratio 1:1.

⁴⁾ Signal transit time with resistive load.

⁵⁾ At supply voltage $> 24 \text{ V}$, $I_{max} = 50 \text{ mA}$. I_{max} is consumption count of all Q_n .

Ambient data

| | |
|--------------------------------------|---------------------------------------------------------------|
| Ambient operating temperature | $-20 \text{ }^\circ\text{C} \dots +50 \text{ }^\circ\text{C}$ |
| Ambient temperature, storage | $-40 \text{ }^\circ\text{C} \dots +70 \text{ }^\circ\text{C}$ |
| Shock load | According to IEC 60068 |
| UL File No. | E181493 |

Classifications

| | |
|---------------------|----------|
| ECLASS 5.0 | 27270906 |
| ECLASS 5.1.4 | 27270906 |
| ECLASS 6.0 | 27270906 |
| ECLASS 6.2 | 27270906 |
| ECLASS 7.0 | 27270906 |
| ECLASS 8.0 | 27270906 |
| ECLASS 8.1 | 27270906 |

| | |
|-----------------------|----------|
| ECLASS 9.0 | 27270906 |
| ECLASS 10.0 | 27270906 |
| ECLASS 11.0 | 27270906 |
| ECLASS 12.0 | 27270906 |
| ETIM 5.0 | EC001820 |
| ETIM 6.0 | EC001820 |
| ETIM 7.0 | EC001820 |
| ETIM 8.0 | EC001820 |
| UNSPSC 16.0901 | 39121528 |

Connection/Pin assignment

| | | | | | | | | | |
|------------------------|---------------------------------------------------------------------------------------------------------------------------------------------------------------------------------------|------|--------|------|----|------|-------|------|---|
| Connection type | Cable with M12 male connector, 4-pin, 0.3 m | | | | | | | | |
| Pin assignment | <table border="0"> <tr> <td>BN 1</td> <td>+ (L+)</td> </tr> <tr> <td>WH 2</td> <td>ET</td> </tr> <tr> <td>BU 3</td> <td>- (M)</td> </tr> <tr> <td>BK 4</td> <td>Q</td> </tr> </table> | BN 1 | + (L+) | WH 2 | ET | BU 3 | - (M) | BK 4 | Q |
| BN 1 | + (L+) | | | | | | | | |
| WH 2 | ET | | | | | | | | |
| BU 3 | - (M) | | | | | | | | |
| BK 4 | Q | | | | | | | | |

Dimensional drawing (Dimensions in mm (inch))

KTM-Lxxxxx2P

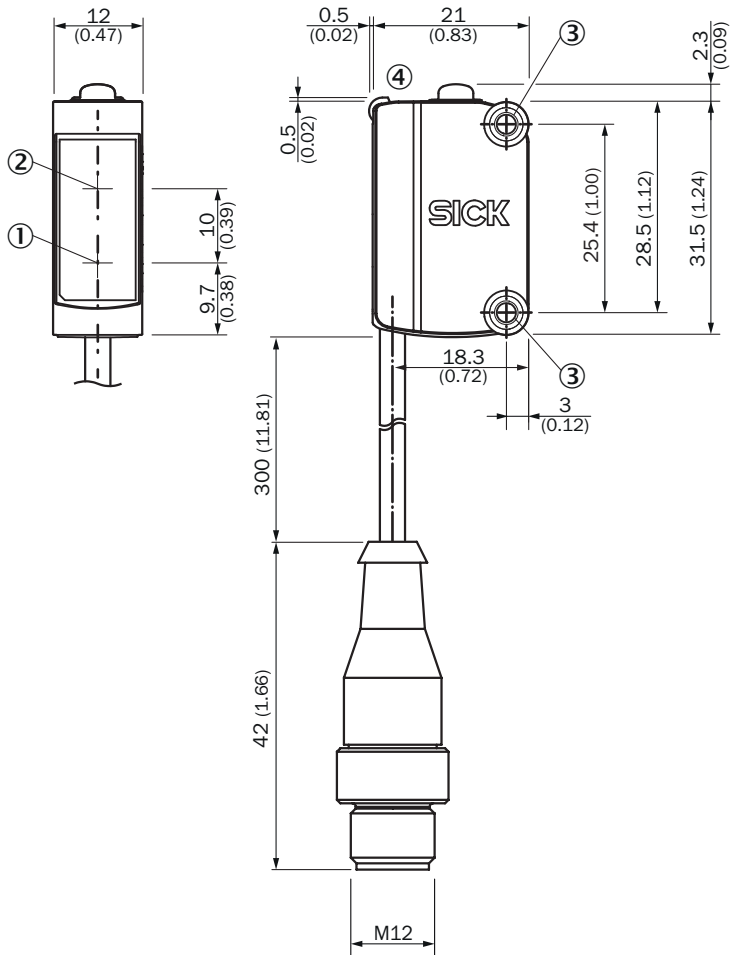

- ① Center of optical axis, sender
- ② Center of optical axis, receiver
- ③ Mounting holes M3
- ④ Display and adjustment elements

Adjustments

Display and adjustment elements

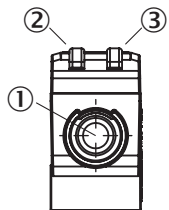

- ① Teach-in button
- ② LED yellow
- ③ LED green

Pin assignment

Connection type. see table: Connection/PIN assignment

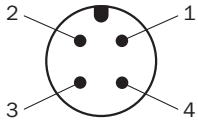

M12 male connector, 4-pin, A-coding

Sensing distance

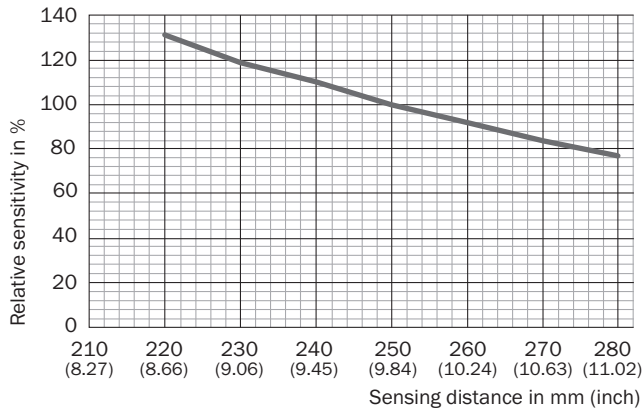

Light spot size

KTM-Lxx5xxxx

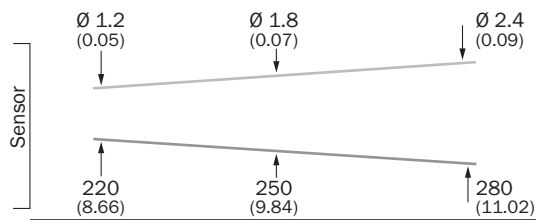

Recommended accessories

Other models and accessories → www.sick.com/KTM

| | Brief description | Type | Part no. |
|-------------------------------------------------------------------------------------|---------------------------------------------------------------------------------------------------------------------------------------------------------------------------------------------------------------------------------------------------------------------------------------------------------------------------------------------------------------------------------------------------|--------------------|----------|
| Plug connectors and cables | | | |
|  | <ul style="list-style-type: none"> Connection type head A: Female connector, M12, 4-pin, straight, A-coded Connection type head B: Flying leads Signal type: Sensor/actuator cable Cable: 5 m, 4-wire, PVC Description: Sensor/actuator cable, unshielded Application: Zones with chemicals | YF2A14-050VB3XLEAX | 2096235 |

| | Brief description | Type | Part no. |
|-----------------------------------------------------------------------------------|-----------------------------------------------------------------------------------------------------------------------------------------------------------------------------------------------------------------------------------------------------------------------------------------------------------------------------------------------------------------------------------------------------------------------------------------|--------------------|----------|
|  | <ul style="list-style-type: none">• Connection type head A: Female connector, M12, 4-pin, straight, A-coded• Connection type head B: Male connector, M12, 4-pin, straight, A-coded• Signal type: Sensor/actuator cable• Cable: 5 m, 4-wire, PVC• Description: Sensor/actuator cable, unshielded• Application: Zones with chemicals | YF2A14-050VB3M2A14 | 2096600 |

SICK AT A GLANCE

SICK is one of the leading manufacturers of intelligent sensors and sensor solutions for industrial applications. A unique range of products and services creates the perfect basis for controlling processes securely and efficiently, protecting individuals from accidents and preventing damage to the environment.

We have extensive experience in a wide range of industries and understand their processes and requirements. With intelligent sensors, we can deliver exactly what our customers need. In application centers in Europe, Asia and North America, system solutions are tested and optimized in accordance with customer specifications. All this makes us a reliable supplier and development partner.

Comprehensive services complete our offering: SICK LifeTime Services provide support throughout the machine life cycle and ensure safety and productivity.

For us, that is “Sensor Intelligence.”

WORLDWIDE PRESENCE:

Contacts and other locations –www.sick.com