



Motion detector
353-852011

4 year warranty



- EN** Motion detector M46HC, DALI-2, secondary and BMS, high ceiling, 18-53 m, 360°, for surface mounting
- NL** Bewegingsmelder M46HC, DALI-2, secundair en BMS, hoge plafonds, 18-53 m, 360°, voor opbouw
- FR** Détecteur de mouvement M46HC, DALI-2, secondaire et BMS, plafond grande hauteur, 18-53 m, 360°, pour montage en saillie
- DE** Bewegungsmelder M46HC, DALI-2, Sekundär und BMS, für hohe Decken, 18-53 m, 360°, für Aufputz
- DK** Bevægelsessensor M46HC, DALI-2, sekundær og BMS, til højløft monteret, 18-53 m, 360°, påbygget
- SE** Rörelsesensor M46HC, DALI-2, sekundär och BMS, hög takhöjd, 18-53 m, 360°, för utanpåliggande monteret
- NO** Bevegelsessensor M46HC, DALI-2, sekundær og BMS, høy takhøyde, 18-53 m, 360°, til utenpåliggende monteret
- IT** Rilevatore di movimento M46HC, DALI-2, secondario e BMS, per soffitti alti, 18-53 m, 360°, per montaggio a parete
- PL** Czujnik ruchu M46HC, DALI-2, podrzędny i BMS, do wysokiego sufitu, 18-53 m, 360°, do montażu natynkowego
- SK** Detektor pohybu M46HC, DALI-2, podrúžný a BMS, na vysoké stropy, 18-53 m, 360°, na povrchovú montáž

Wiring ⚠️ 230 V/DALI power - OFF

Aansluitschema / Schéma de raccordement / Verdrahtung / Tíslutningsskema / Kopplingschema / Ledningstilkopling / Cablaggio / Okablowanie / Inštalácia

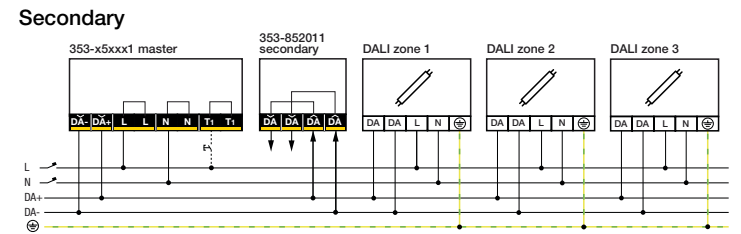

⚠️ This product must be secured with a miniature circuit breaker (MCB) of max. 16 A in the electrical cabinet. The MCB rating is limited by national installation rules.

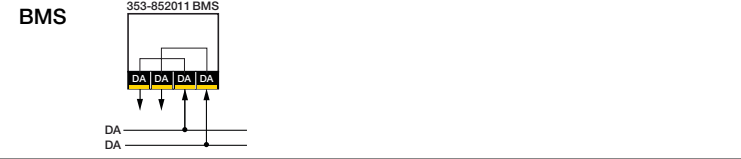

Dimensions

Afmetingen / Dimensions / Abmessungen / Dimensioner / Mått / Dimensjoner / Dimensoni / Wymiary / Rozmery

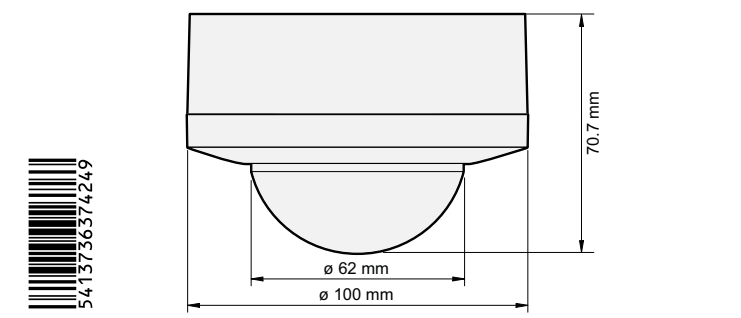

Installation ⚠️ 230 V/DALI power - OFF

Installatie / Installation / Installation / Installation / Installation / Installasjon / Installazione / Instalacja / Inštalácia

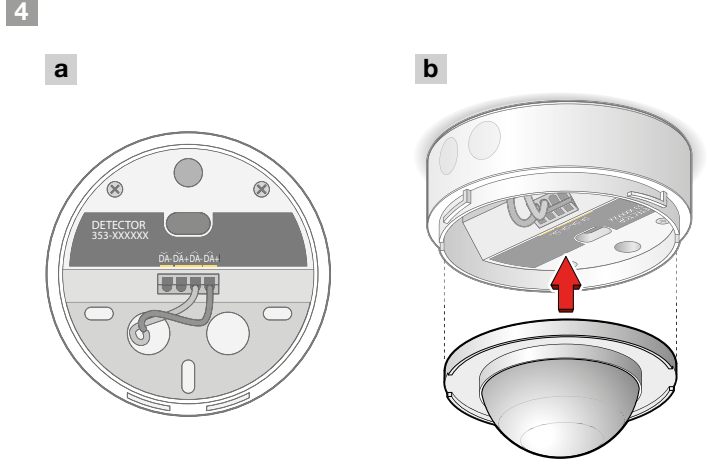
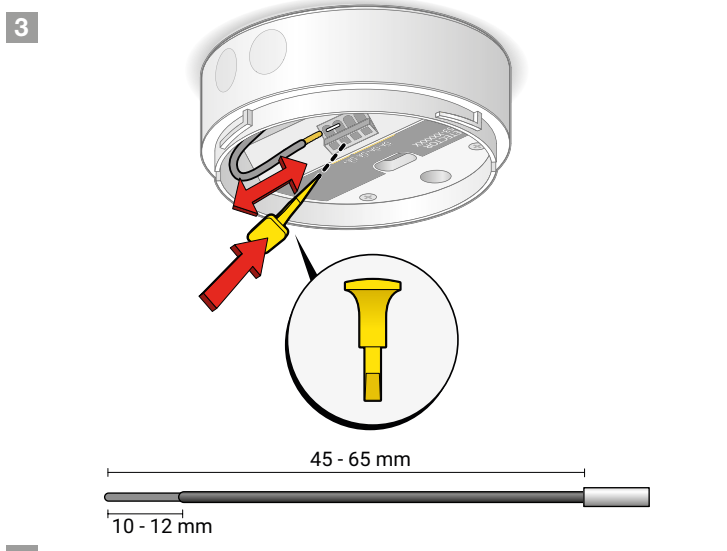
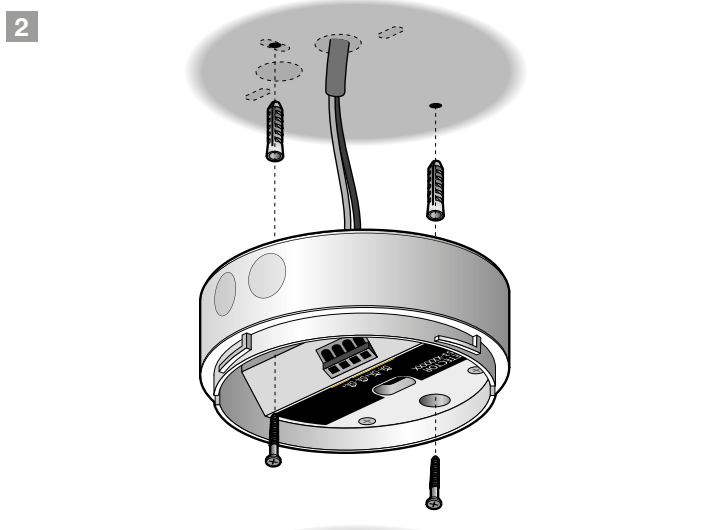
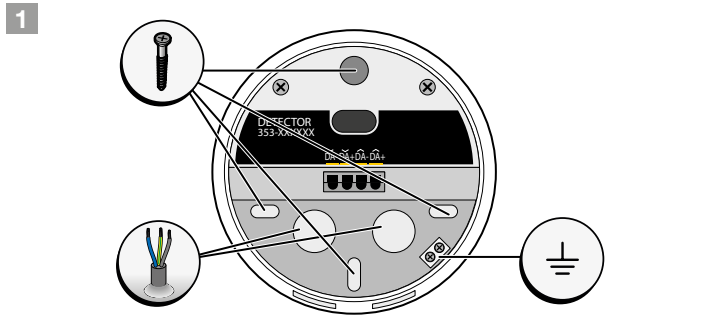

5

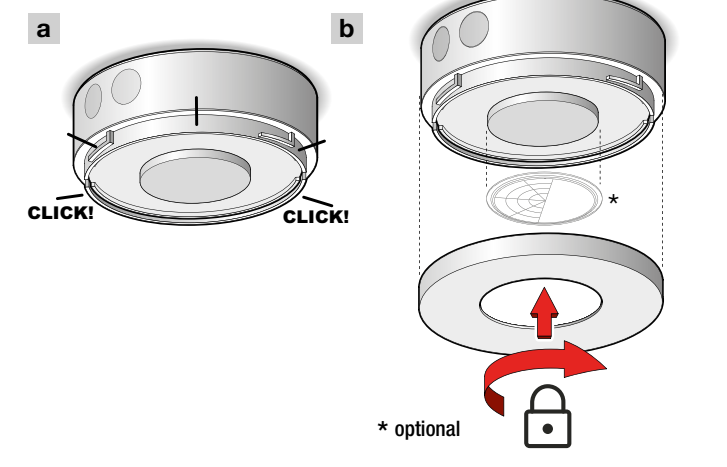

- EN** If a grommet needs to be replaced, please make sure the new grommet is halogen-free.
- NL** Indien de dichtingsring vervangen moet worden, kies dan voor een nieuwe, halogeenvrije dichtingsring.
- FR** Si un passe-câble doit être remplacé, veillez à ce que le nouveau passe-câble soit exempt d'halogène.
- DE** Wenn eine Durchführungsichtung ausgetauscht werden muss, stellen Sie bitte sicher, dass die neue Durchführungsichtung halogenfrei ist.
- DK** Hvis en membran skal udskiftes, er det vigtigt, at den nye er halogenfri.
- SE** Om en tätningring måste bytas ut ska du kontrollera att den nya tätningringen är halogenfri.
- NO** Sørg for at den nye pakningen er uten halogen dersom ringpakningen må byttes ut.
- IT** In caso di sostituzione di un occhio, assicurarsi che il nuovo occhio sia privo di alogeni.
- PL** Jeśli konieczna jest wymiana przelotki, należy upewnić się, że nowa przelotka nie zawiera halogenów.
- SK** Ak je potrebné vymeniť priechodku, uistite sa, že nová priechodka je bez halogénov.

Dismantling ⚠️ 230 V/DALI power - OFF

Demontage / Démontage / Demontage / Demontering / Demontera / Demontering / Smontaggio / Odmontowanie / Demontáž

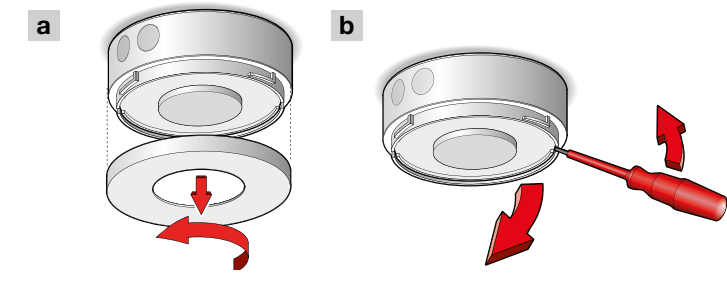

App settings ⚠️ 230 V/DALI power - ON

App-instellingen / Réglages de l'appli / App-Einstellungen / App indstillinger / Appinställningar / App-innstillinger / Impostazioni dell'app / Ustawienia aplikacji / Nastavenia aplikácie

	Sensitivity
Factory Settings	High



Settings by BMS software ⚠️ DALI power - ON

DALI BMS-instellingen / Réglages DALI BMS / DALI BMS Einstellungen / DALI BMS indstillinger / DALI BMS-Appinställningar / DALI BMS-innstillinger / Impostazioni DALI BMS / Ustawienia DALI BMS / Nastavenia DALI BMS

Table memory bank 2			
Address	Description	Default value	Memory type
0x00	Address and last accessible memory location	0x03	ROM
0x01	Indicator byte (manufacture definable)	0x00	any
0x02	Memory bank lock byte (<0x55 = Read Only else Read/ Write)	0xFF	RAM
0x03	PIR sensitivity segment A (MR, LR and HC detectors) 4 = MAX 3 = HIGH 2 = LOW 1 = MIN 0 = OFF	0x03	NVM
0x04	PIR sensitivity segment B (LR and HC detectors) 4 = MAX 3 = HIGH 2 = LOW 1 = MIN 0 = OFF	0x03	NVM
0x05	PIR sensitivity segment C (LR and HC detectors) 4 = MAX 3 = HIGH 2 = LOW 1 = MIN 0 = OFF	0x03	NVM
0x06	LUX range 0 = NORMAL 0 - 1023 lux, 10-bit 1 = HIGH 0 - 10360 lux, 14 bit	0x00	NVM
0x07	Bluetooth® communication 0 = enabled, 1 = disabled	0x00	NVM

Note: The detector reboots when Bluetooth® communication is disabled or re-enabled. This lasts for approximately 100 - 500 ms.

LED behaviour ⚠️ 230 V/DALI power - ON

Ledgedrag / Comportement des LED / LED-Verhalten / LED funktioner / LED-funktioner / LED-funksjon / Comportamento del LED / Zachowanie LED / LED signalizácia

EN			
Green LED continuous on	●	Connection OK	
Green LED flashing	⚡	Warming up*	Wait
Red LED continuous on	●	Error	More info -->
Blue LED flashing	⚡	Walk test active	

*When Bluetooth® communication is disabled, the green LED does not flash while warming up.

NL			
Groene led brandt	●	Verbinding OK	
Groene led knippert	⚡	Warmt op*	Even geduld
Rode led brandt	●	Fout	Meer informatie -->
Blaauwe led knippert	⚡	Wandeltest geactiveerd	

*Als Bluetooth®-communicatie uitgeschakeld is, zal de groene led niet knipperen tijdens het opwarmen.

FR			
LED verte allumée en continu	●	Connexion OK	
LED verte clignote	⚡	Chauffe*	Attendez
LED rouge allumée en continu	●	Erreur	Plus d'info -->
LED bleue clignote	⚡	Test de mouvement actif	

* Lorsque la communication Bluetooth® est désactivée, le voyant vert ne clignote pas pendant le démarrage.

DE			
Grüne LED leuchtet	●	Verbindung OK	
Grüne LED blinkt	⚡	Aufwärmen*	Warten
Rote LED leuchtet	●	Fehler	Mehr Info -->
Blaue LED blinkt	⚡	Bewegungstest aktiv	

* Wenn die Bluetooth®-Kommunikation deaktiviert ist, blinkt die grüne LED während der Aufwärmphase nicht.

Grøn LED lyser konstant	●	<i>Forbindelse OK</i>	
Grøn LED blinker hurtigt	☀	<i>Varmer op*</i>	<i>Vent</i>
Rød LED lyser konstant	●	<i>Fejl</i>	<i>Mere info --></i>
Blå LED blinker hurtigt	☀	<i>Gå-test aktiv</i>	

* Når Bluetooth® kommunikation deaktiveres, blinker den grønne LED ikke under opvarmning.

Grøn LED kontinuerligt på	●	<i>Anslutning OK</i>	
Grøn LED blinkar	☀	<i>Värmer upp*</i>	<i>Vänta</i>
Röd LED kontinuerligt på	●	<i>Fel</i>	<i>Mer information --></i>
Blå LED blinkar	☀	<i>Promenadtest aktivt</i>	

* När Bluetooth®-kommunikation är inaktiverad, blinkar inte den gröna LED under uppvärmningen.

Grønn lysdiode kontinuerlig på	●	<i>Tilkopling OK</i>	
Grønn lysdiode blinker	☀	<i>Varmes opp*</i>	<i>Vent</i>
Rød lysdiode kontinuerlig på	●	<i>Feil</i>	<i>Mer info --></i>
Blå lysdiode blinker	☀	<i>Funksjonstest virksom</i>	

* Når Bluetooth®-kommunikasjon er deaktivert, blinker ikke den grønne LED-en under oppvarming.

LED verde sempre acceso	●	<i>Connessione OK</i>	
LED verde lampeggiante	☀	<i>Riscaldamento*</i>	<i>Attendere</i>
LED rosso sempre acceso	●	<i>Errore</i>	<i>Ulteriore info --></i>
LED blu lampeggiante	☀	<i>Test di camminare</i>	

* Quando la comunicazione Bluetooth® è disattivata, il LED verde non lampeggia durante il riscaldamento.

Zielona dioda LED świeci światłem ciągłym	●	<i>Połączenie OK</i>	
Zielona dioda LED miga	☀	<i>Rozgrzewanie*</i>	<i>Czekaj</i>
Czerwona dioda LED świeci światłem ciągłym	●	<i>Błąd</i>	<i>Więcej informacji --></i>
Niebieska dioda LED miga	☀	<i>Test przejścia aktywny</i>	

* Gdy komunikacja Bluetooth® jest wyłączona, zielona dioda LED nie miga podczas rozgrzewania.

Zelená LED kontrolka svieti	●	<i>Pripojenie OK</i>	
Zelená LED kontrolka bliká	☀	<i>Zahrievanie*</i>	<i>Počkajte</i>
Červená LED svieti	●	<i>Chyba</i>	<i>Viac informácií --></i>
Modrá LED bliká	☀	<i>Test chodenia je aktívny</i>	

* Keď je Bluetooth® komunikácia vypnutá, zelená LED dióda počas zahrievania nebliká.

Specifications

Specificaties / Specifications / Spezifikationen / Specifikationer / Specifikationer / Spesifikasjoner / Specifice / Specyfikacje / Technické údaje

Article number	353-852011
Configuration	DALI-2 secondary/BMS
Input voltage	via the DALI bus
Maximum current consumption	28.1 mA
Nominal current consumption (12 V, 25°C) Bluetooth® enabled	8.1 mA
Nominal current consumption (12 V, 25°C) Bluetooth® disabled	5.0 mA
Maximum startup time DALI	< 1200 ms
Maximum PIR detection startup time	70 s
Detection angle	360 °
Detection range (PIR)	ø 53 m from a height of 12 m
Light intensity range	0 – 10360 lux (see DALI BMS settings)
Ambient temperature	-25 – +40 °C
Mounting method	surface mounting
Mounting height	4 - 12 m
Colour	white (RAL 9010)
Dimensions visible (HxWxD)	100 x 100 x 70.7 mm
Dimensions (HxWxD)	100 x 100 x 70.7 mm
Wire capacity	1.5/2.5 mm²
Maximum range Bluetooth® (free field, depending on the device)	50 m
Operating frequency	2.4 GHz
Maximum radio frequency power	-2 dBm
Protection degree	IP54
Impact resistance	IK04
Modification of settings	app (iOS/Android) and 2-way Bluetooth® communication/BMS software
Halogen-free	yes
Marking	CE

Detection area

Detectieberek / Portée de détection / Erfassungsbereich / Rækkevidde / Detekteringsområde / Overvåkningsområde / Campo di rilevamento / Obszar wykrywania / Oblasť snímania

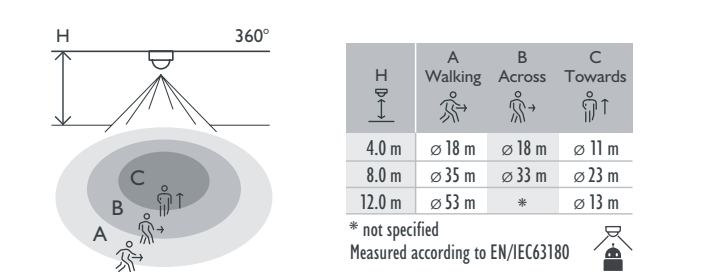

Troubleshooting

Probleemoplossing / Résolution des problèmes / Fehlerbehebung / Fejlfinding / Felsökning / Feilsøking / Risoluzione dei problemi / Rozwiązywanie problemów / Pomoc a podpora

EN		
<i>Problem</i>	<i>Possible cause</i>	<i>Proposed solution</i>
Load does not turn on	The wiring is not correct	Check the wiring scheme
Load does not turn off	The detector receives false triggers	Check for any objects that may cause false triggering and remove them from the detection range or lower the sensitivity
App cannot connect to the detector	Bluetooth® has been disabled on your mobile device or on the detector	Enable Bluetooth® on your mobile device or on the detector

NL		
<i>Probleem</i>	<i>Mogelijke oorzaak</i>	<i>Voorgestelde oplossing</i>
De belasting schakelt niet in	De bedrading is niet correct aangesloten	Raadpleeg het aansluitschema
De belasting schakelt niet uit	De detector ontvangt valse triggers	Controleer of er in het detectiegebied objecten aanwezig zijn die valse triggers kunnen veroorzaken en verwijder deze of verlaag de gevoeligheid
De app kan geen verbinding maken met de detector	Bluetooth® is gedeactiveerd op je mobiel toestel of op de melder	Activeer Bluetooth® op je mobiel toestel of op de melder

FR		
<i>Problème</i>	<i>Cause possible</i>	<i>Solution proposée</i>
La charge ne s'active pas	Le câblage n'est pas raccordé correctement.	Consultez le schéma de raccordement
La charge ne se désactive pas	Le détecteur reçoit de faux déclenchements	Vérifiez si des objets pouvant causer de faux déclenchements sont présents dans la zone de détection et éliminez-les ou diminuez la sensibilité
L'appli ne trouve pas le détecteur	Bluetooth® désactivé sur votre smartphone ou sur le détecteur	Activez Bluetooth® sur votre smartphone ou sur le détecteur

DE		
<i>Problem</i>	<i>Mögliche Ursache</i>	<i>Lösungsvorschlag</i>
Das Licht schaltet sich nicht ein	Die Verdrahtung wurde nicht richtig angeschlossen	Richten Sie sich nach dem Anschlussplan
Das Licht schaltet sich nicht aus	Der Detektor empfängt falsche Signale	Kontrollieren Sie, ob sich Gegenstände im Erfassungsbereich befinden, die die Ursache für falsche Signale sein können und entfernen Sie diese oder senken Sie die Empfindlichkeit des Melders
Die App kann keine Verbindung herstellen	Bluetooth® ist auf Ihrem mobilen Gerät deaktiviert oder am Detektor	Aktivieren Sie Bluetooth® auf Ihrem mobilen Gerät oder am Detektor

DK		
<i>Problem</i>	<i>Mulig årsag</i>	<i>Løsningsforslag</i>
Belastning tænder ikke	Fortrådning er ikke korrekt	Check tilslutningsskema
Belastning slukker ikke	Sensoren fejltændinger	Kontroller for genstande, der kan forårsage fejltænding og fjern dem fra detekteringsområdet eller minimere følsomheden
App kan ikke få forbindelse til sensoren	Bluetooth® er blevet deaktiveret på din mobile enhed eller på detektoren	Aktiver Bluetooth® på din mobile enhed eller på detektoren

SE		
<i>Problem</i>	<i>Möjlig orsak</i>	<i>Föreslagen lösning</i>
Belastningen slås inte på	Ledningsdragningen är inte korrekt	Kontrollera kopplingskemat
Belastningen stängs inte av	Detektorn tar emot falsklarm	Kontrollera om något objekt kan utlösa falsklarm och ta bort dem från detektionsområdet eller sänk känsligheten
Appen kan inte ansluta till detektorn	Bluetooth® har inaktiverats på din mobila enhet eller på detektorn	Aktivera Bluetooth® på din mobila enhet eller på detektorn

NO		
<i>Problem</i>	<i>Mulig årsak</i>	<i>Løsningsforslag</i>
Strømforsyningen koples ikke på	Ledningstilkoplingen er ikke riktig utført	Sjekk koplingskjemaet
Strømforsyningen koples ikke ut	Sensoren mottar falske triggerere	Kontroller alle gjenstander som kan forårsake falske triggerere, og fjern dem fra overvåkningsområdet eller reduser følsomhet
App kan ikke tilkoples sensoren	Bluetooth® har blitt deaktivert på mobilenheten din eller på detektoren	Aktiver Bluetooth® på mobilenheten din eller på detektoren

IT		
<i>Problema</i>	<i>Possibile causa</i>	<i>Soluzione proposta</i>
Il carico non si accende	Il collegamento elettrico è errato	Controllare lo schema elettrico
Il carico non si spegne	Il rilevatore riceve inneschi errati	Verificare la presenza di oggetti che potrebbero innescare attivazioni errate e rimuoverli dal campo di rilevamento o abbassare la sensibilità.
La app non riesce a connettersi al rilevatore	Il Bluetooth® è stato disabilitato sul dispositivo mobile o sul rilevatore	Abilitare il Bluetooth® sul dispositivo mobile o sul rilevatore

PL		
<i>Problem</i>	<i>Możliwa przyczyna</i>	<i>Proponowane rozwiązanie</i>
Obciążenie nie włącza się	Okablowanie nie jest prawidłowe	Sprawdź schemat okablowania
Obciążenie się nie wyłącza	Detektor otrzymuje fałszywe wyzwalacze	Sprawdź, czy jakiegokolwiek obiekty nie powodują fałszywego wyzwalania i usuń je z zakresu wykrywania lub zmniejsz czułość
Aplikacja nie może połączyć się z wykrywaczem	Bluetooth® został wyłączony w urządzeniu mobilnym lub w wykrywaczu	Włącz Bluetooth® na urządzeniu mobilnym lub w wykrywaczu

SK		
<i>Problém</i>	<i>Možná príčina</i>	<i>Navrhované riešenie</i>
Svetlo sa nezapne	Detektor nie je správne zapojený	Skontrolujte schému zapojenia
Svetlo sa nevyhne	Detektor prijíma falošné spúšťače	Skontrolujte akékoľvek objekty, ktoré môžu spôsobovať falošné spustenie a odstráňte ich z detegovanej oblasti, alebo znížte citlivosť
Aplikácia sa nevie pripojiť k detektoru	Na vašom mobilnom zariadení alebo na detektore je vypnutý Bluetooth®	Zapnite Bluetooth® na vašom mobilnom zariadení alebo na detektore

PT		
<i>Problema</i>	<i>Causa possível</i>	<i>Solução proposta</i>
O carregamento não funciona	O esquema de ligação elétrica está incorreto	Verifique o esquema de ligação elétrica
O carregamento não desliga	O detetador recebe disparos falsos	Verifique a presença de objetos que possam causar disparos falsos e remova-os do campo de deteção ou reduza a sensibilidade
O aplicativo não consegue conectar-se ao detetador	O Bluetooth® foi desativado no seu dispositivo móvel ou no detetador	Ative o Bluetooth® no seu dispositivo móvel ou no detetador

ES		
<i>Problema</i>	<i>Causa posible</i>	<i>Solución propuesta</i>
El cargamento no funciona	El esquema de conexión eléctrica está incorrecto	Verifique el esquema de conexión eléctrica
El cargamento no se apaga	El detector recibe disparos falsos	Verifique la presencia de objetos que puedan causar disparos falsos y elimínelos del campo de detección o reduzca la sensibilidad
La aplicación no puede conectarse al detector	Bluetooth® está desactivado en su dispositivo móvil o en el detector	Active Bluetooth® en su dispositivo móvil o en el detector

www.niko.eu		
EN	+32 3 778 90 80	support@niko.eu
NL	België: +32 3 778 90 80 Nederland: +31 880 15 96 10	support.be@niko.eu support.nl@niko.eu
FR	Belgique: +32 3 778 90 80 France: +33 820 20 66 25 Suisse: +41 44 878 22 22	support.be@niko.eu support.fr@niko.eu support.ch@niko.eu
DE	Deutschland: +49 7623 96697-0 Schweiz: +41 44 878 22 22 Österreich: +43 1 7965514 Belgien: +32 3 778 90 80	support.de@niko.eu support.ch@niko.eu support.at@niko.eu support.be@niko.eu
DK	+45 74 42 47 26	support.dk@niko.eu
SE	+46 8 410 200 15	support.se@niko.eu
NO	+47 66 77 57 50	support.no@niko.eu
IT	+41 44 878 22 22	support.ch@niko.eu
PL	+48 509 378 373	support.pl@niko.eu
SK	+421 2 63 825 155	support.sk@niko.eu

Niko prepares its manuals with the greatest care and strives to make them as complete, correct and up to date as possible. Nevertheless, some deficiencies may subsist. Niko cannot be held responsible for this, other than within the legal limits. Please inform us of any deficiencies in the manuals by contacting Niko customer services at support@niko.eu.