

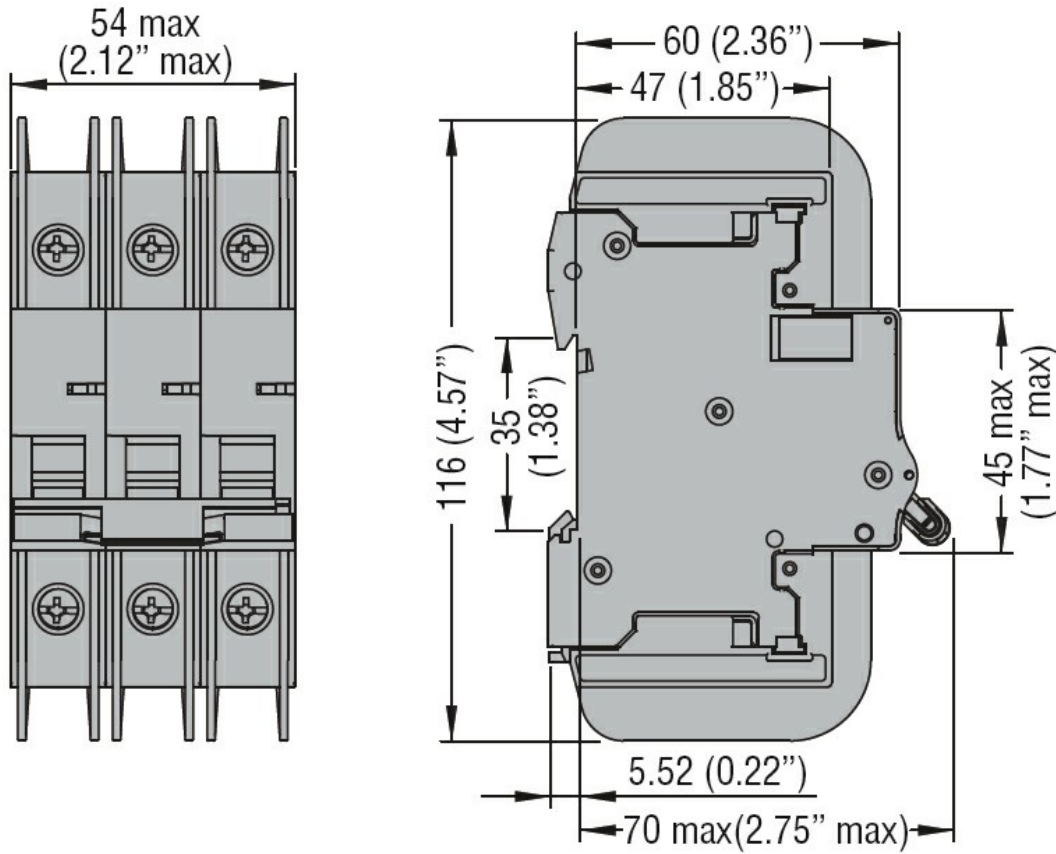

Product designation	Miniature circuit breaker (MCB)				
Product type designation	P1 MB				
Number of poles	3P				
Number of DIN modules	3				
Compliance	IEC / UL489				
Electrical features					
Rated insulation voltage U_i IEC/EN	V	440			
Rated impulse withstand voltage U_{imp}	kV	4			
Rated operational voltage AC (IEC)	VAC	230/400			
Rated operational voltage AC (UL)	V	480Y/277			
Rated frequency	Hz	50/60			
Rated current (I_n)	A	8			
Tripping curve	C				
Short circuit rating (IEC)	kA	10			
Short circuit rating (UL)	kA	10			
Electrical life	cycles	10000			
Power dissipation per pole max	W	1.25			
Ambient conditions					
Operating temperature	min	°C	-40		
	max	°C	+70		
Storage temperature	min	°C	-40		
	max	°C	+80		
Max altitude	m	2000			
Mechanical features					
Operating position	normal	Vertical plan			
Fixing	35mm DIN rail				
Tightening torque for terminals	min	Nm	1.8		
	max	Nm	2		
	min	lbin	16		
	max	lbin	17.7		
Terminals tool	Pz 2				
Conductor section	IEC	min	mm ²	1	
		max	mm ²	35	
	AWG/Kcmil	min	14		
		max	6		
		Mechanical life			cycles 20000
		Weight			g 388

Frontal IP degree	IP20
Pollution degree	2

Dimensions



Wiring diagrams

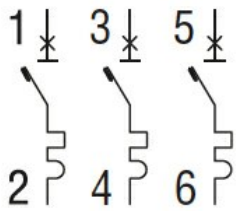

Certifications and compliance

Compliance	IEC/EN 60947-2
	UL489
Certifications	cULus
	EAC

ETIM classification

ETIM 8.0	EC000042 - Miniature circuit breaker (MCB)
----------	--