



Product designation	Three-phase energy meters		
Product type designation	DMED305T2		
Type	Three-phase with and without neutral		
DIN rail module number	4		
Auxiliary supply Us			
Operational frequency	min	Hz	50
	max	Hz	60
Power consumption	Max	VA	3.5
Power dissipation Max		W	2.7
Measuring voltage inputs			
Rated voltage (Ue)	phase-phase	VAC	380...415
	phase-neutral	VAC	220...240
Operating voltage range	phase-phase	VAC	323...456
	phase-neutral	VAC	187...264
Connection method	Via CT		
Current			
IEC maximum (Imax)		A	5
IEC minimum (Imin)		A	0.05
IEC rated (Iref-Ib)		A	5
IEC start (Ist)		mA	0.005
Transition (Itr)		A	0.25
Accuracy			
	Active energy		Class 0.5s (IEC/EN 62053-22)
	Reactive energy		Class 2 (IEC/EN 62053-23)
Output characteristics			
LED Pulse rate		pulse/kWh	1000
LED Pulse duration		ms	30
Static output pulse rate		pulse/kWh	0.1-1-10-100 programmable
Static output pulse duration		ms	100
Static output external voltage		VDC	10...30
Static outputs Maximum current		mA	50
Insulations			
Rated insulation voltage Ui IEC/EN		V	250
Rated impulse withstand voltage Uimp		kV	6
Operating frequency withstand voltage		kV	4

Mechanical features

Housing type	Polyamide		
Terminals type	Fixed		
Conductor cross section	min	mm ²	0.2
			4 for supply voltage measurement;
	Max	mm ²	2.5 for current measurement
	min	AWG	24
	Max	AWG	12
Tightening torque (Max)		Nm	0.8
		lbin	7
Fixing	Din rail		
Weight		g	332

Ambient conditions

Temperature	Operating temperature		
	min	°C	-25
	max	°C	+55
	Storage temperature		
	min	°C	-25
	max	°C	+70
Relative humidity		%	<80
Maximum Pollution degree			2

Dimensions

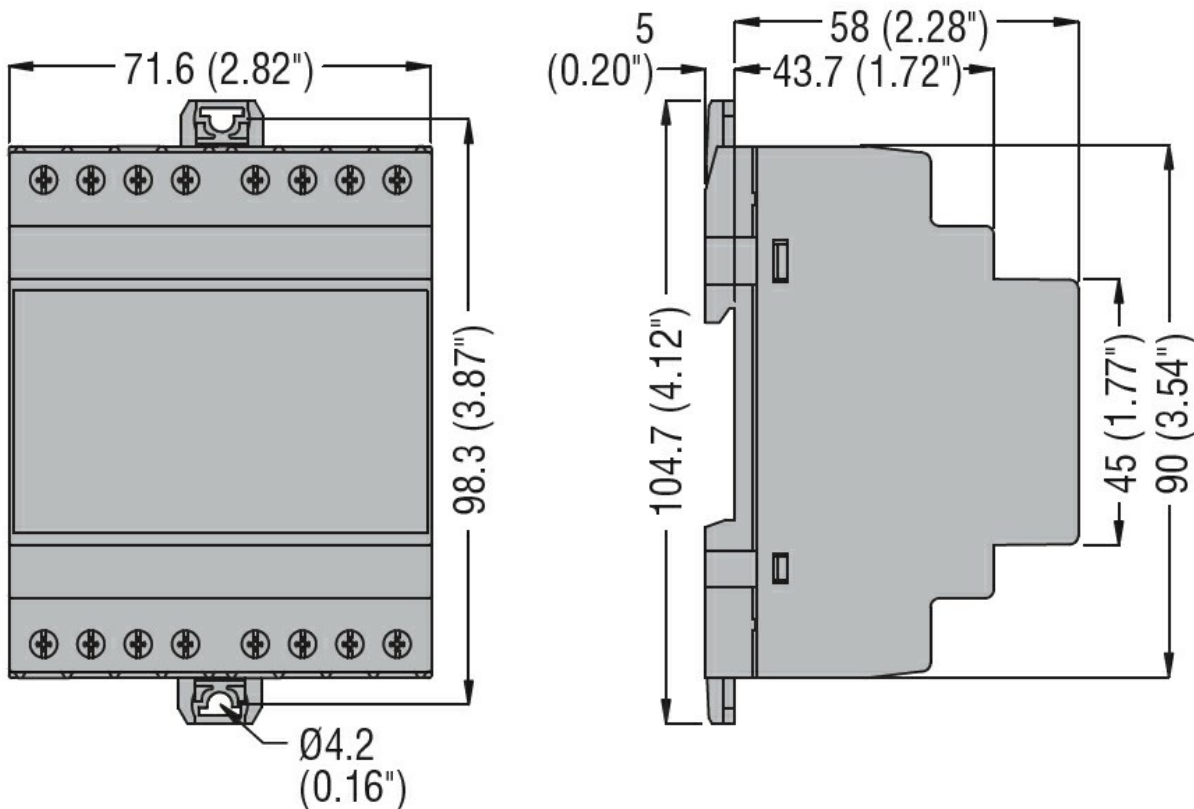

Wiring diagrams

Single-phase

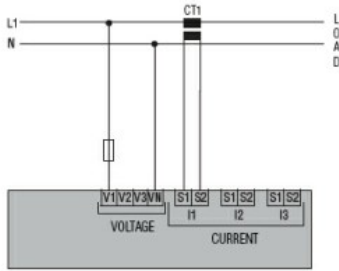

Two-phase

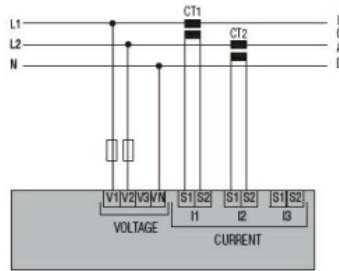

Three-phase with or without neutral

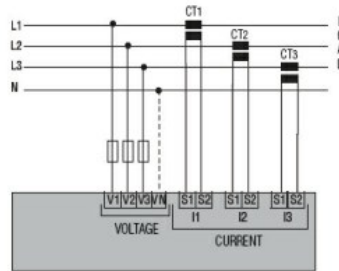

Three-phase without neutral in ARON connection

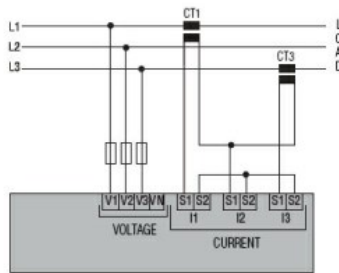
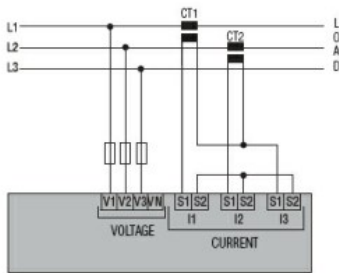

Tariff input

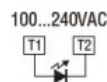

Pulse output 30VDC 50mA for DME D305 T2

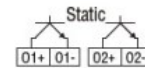

RS485 for DME D330



M-Bus for DME D332

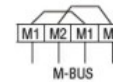

Certifications and compliance

Compliance

IEC/EN 50470-1
IEC/EN 61010-1
IEC/EN 61010-2-030

Certificates

EAC
RCM

ETIM classification

ETIM 8.0

EC001506 -
Kilowatt-hour
meter