

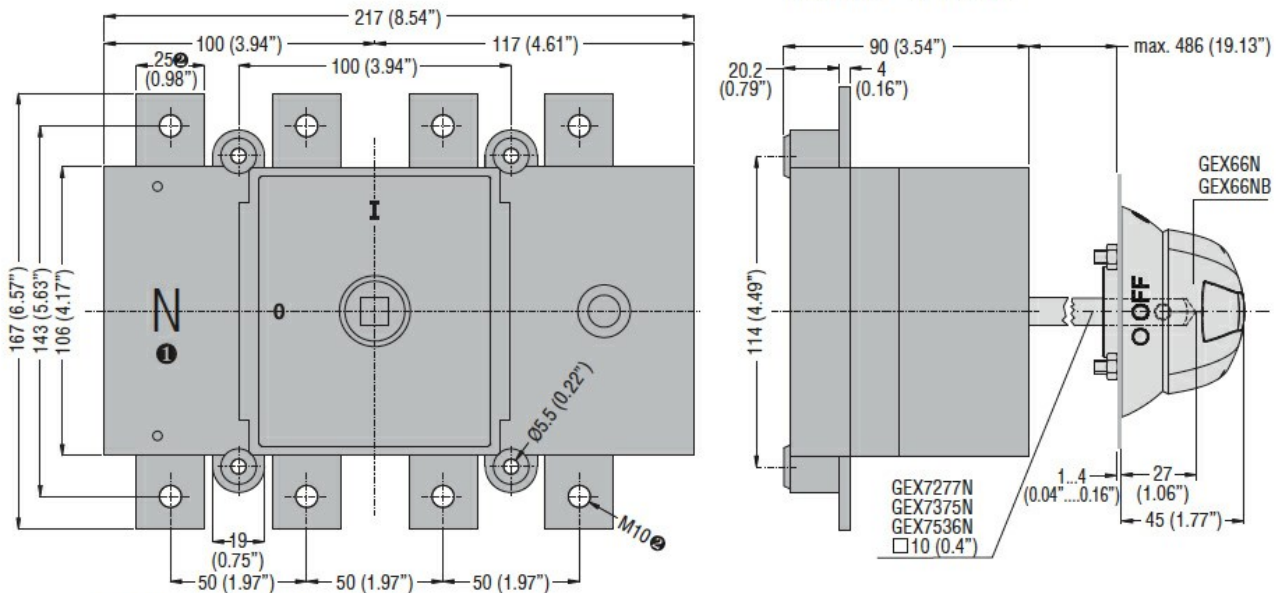

Product designation				Switch disconnecter
Product type designation				GE
Number of poles	Nr.			4
Operating voltage type				AC
Contact characteristics				
IEC Conventional free air thermal current I _{th}	A			250
Rated insulation voltage U _i IEC/EN	V			1000
Rated impulse withstand voltage U _{imp}	kV			8
Operating current I _e				
AC21A	400V	A	250	
	500V	A	250	
	690V	A	200	
AC22A	400V	A	250	
	500V	A	250	
	690V	A	160	
AC23A	400V	A	250	
	500V	A	200	
	690V	A	160	
Power dissipation per pole max	W		2.5	
Rated operational power AC23A	400V	kW	138	
	690V	kW	153	
Rated short time current (1s) I _{cs} (rms)	kA		12	
Conditional short-circuit current (rms)	kA		100	
Short-circuit protection with fuse	Class/A	gG250		
Making capacity AC23A 400V	A	2500		
Breaking capacity AC23A 400V	A	2000		
Mechanical life	cycles	20000		
Electrical life AC21A	cycles	1000 (AC23A 400V)		
Mechanical features				
Operating position	normal allowable	Vertical plan Any		
Fixing	Screw			
Terminals	type screw	Bar M10		
Tightening torque for terminals	max	Nm	18	
	max	Ibin	10	

Bar dimensions max	25x4		
Ambient conditions			
Operating temperature	min	°C	-25
	max	°C	55
Storage temperature			
	min	°C	-40
	max	°C	70
Max altitude	m		3000
Resistance & Protection			
Frontal IP degree	IP20		
Pollution degree	3		
Dimensions			

**Door coupling version with handle
GEX66N - GEX66NB**



- ❶ Not indicated on GE... DT4 type.
- ❷ 20mm (0.79") and M8 for GE0125 DT4 type.

**Direct operating version with handle
GEX66ND**

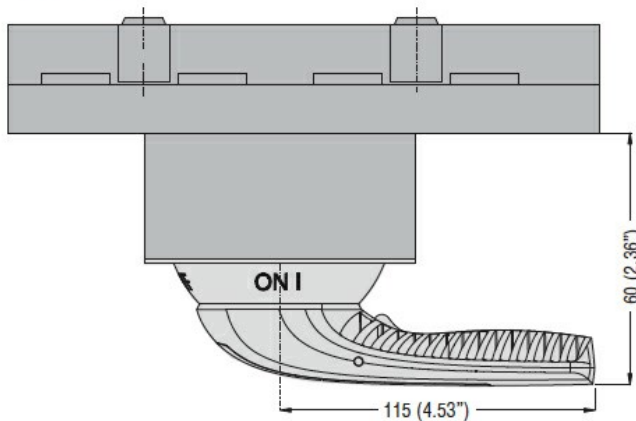

Wiring diagrams

Four-pole disconnectors
GE0160 T4 - GE1600 T4
GE0160 T4P

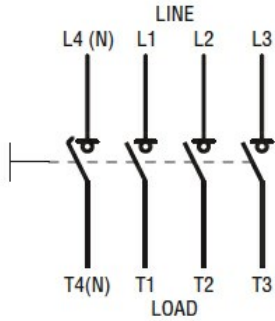

Certifications and compliance

Compliance

IEC/EN 60947-1

IEC/EN 60947-3

Certifications

EAC

ETIM classification

ETIM 8.0

EC000216 -
 Switch
 disconnector