



MLG25N-0425N10501

MLG-2

MEASURING AUTOMATION LIGHT GRIDS

SICK
Sensor Intelligence.



Illustration may differ



Ordering information

| Type | Part no. |
|-------------------|----------|
| MLG25N-0425N10501 | 1218885 |

Other models and accessories → www.sick.com/MLG-2

Detailed technical data

Features

| | |
|--|---|
| Device version | ProNet - Advanced functionality incl. fieldbus |
| Sensor principle | Sender/receiver |
| Minimum detectable object (MDO) | 25 mm, 29 mm ^{1) 2) 3)} |
| Beam separation | 25 mm |
| Type of synchronization | Cable |
| Number of beams | 18 |
| Detection height | 425 mm |
| Software features (default) | Q ₁ Presence detection |
| Operating mode | Standard ✓ Transparent ✓ Dust- and sunlight-resistant ✓ |
| Function | Cross beam ✓ Beam blanking ✓ High measurement accuracy ✓ |
| Applications | Switching output Object recognition/object width Object recognition Height classification Hole detection/hole size Outside dimension/inside dimension Object position Hole position Zone definition |

¹⁾ MDO min. detectable object at high measurement accuracy.

²⁾ MDO min. detectable object for standard measurement accuracy.

³⁾ Depending on beam separation without cross beam setting.

| | |
|------------------------|---|
| Data interface | Object detection Hole detection Object height measurement Measurement of external dimension Measurement of inside dimension Measurement of object position Measurement of hole position |
| Included with delivery | 1 × sender 1 × receiver 1 × Fieldbus module 4/6 × QuickFix brackets (6 × QuickFix brackets for monitoring heights above 2 m) 1 × Quick Start Guide |

- 1) MDO min. detectable object at high measurement accuracy.
2) MDO min. detectable object for standard measurement accuracy.
3) Depending on beam separation without cross beam setting.

Mechanics/electronics

| | |
|-------------------------------------|--|
| Light source | LED, Infrared light |
| Wave length | 850 nm |
| Supply voltage V_s | DC 19.2 V ... 28.8 V ¹⁾ |
| Power consumption sender | 55.9 mA ²⁾ |
| Power consumption receiver | 123.6 mA ²⁾ |
| Fieldbus module current consumption | 115 mA |
| Ripple | < 5 V _{pp} |
| Output current I_{max} | 100 mA |
| Output load, capacitive | 100 nF |
| Output load, Inductive | 1 H |
| Initialization time | < 1 s |
| Switching output | Push-pull: PNP/NPN |
| Connection type | Male connector M12, 5-pin, 0.22 m Connector M12, 12-pin, 0.21 m |
| Housing material | Aluminum |
| Indication | LED |
| Enclosure rating | IP65, IP67 ³⁾ |
| Circuit protection | U _v connections, reverse polarity protected Output Q short-circuit protected Interference pulse suppression |
| Protection class | III |
| Weight | 1.149 kg |
| Front screen | PMMA |
| Option | None |
| UL File No. | NRKH.E181493 (Sensor) |

- 1) Without load.
2) , Without load with 24 V.
3) Operating in outdoor condition only with a external protection housing.

Performance

| | |
|------------------------|----------------------|
| Maximum range | 7 m ¹⁾ |
| Minimum range | ≥ 0 m |
| Operating range | 5 m |
| Response time | 3.6 ms ²⁾ |

¹⁾ No reserve for environmental issue and deterioration of the diode.

²⁾ Without high speed.

Communication interface

| | |
|-----------------------|----------------|
| PROFINET | ✓ |
| Digital output | Q ₁ |
| Number | 1 |

Ambient data

| | |
|--------------------------------------|--|
| Shock resistance | Continuous shocks 10 g, 16 ms, 1000 shocks Single shocks 15 g, 11 ms 3 per axle |
| Vibration resistance | Sinusoidal oscillation 10-150 Hz 5 g |
| EMC | EN 60947-5-2 |
| Ambient light immunity | Direct: 150,000 lx ¹⁾ Indirect: 200,000 lx ²⁾ |
| Ambient operating temperature | -30 °C ... +55 °C |
| Ambient temperature, storage | -40 °C ... +70 °C |

¹⁾ Outdoor mode.

²⁾ Light resistance indirect.

Classifications

| | |
|-----------------------|----------|
| ECLASS 5.0 | 27270910 |
| ECLASS 5.1.4 | 27270910 |
| ECLASS 6.0 | 27270910 |
| ECLASS 6.2 | 27270910 |
| ECLASS 7.0 | 27270910 |
| ECLASS 8.0 | 27270910 |
| ECLASS 8.1 | 27270910 |
| ECLASS 9.0 | 27270910 |
| ECLASS 10.0 | 27270910 |
| ECLASS 11.0 | 27270910 |
| ECLASS 12.0 | 27270910 |
| ETIM 5.0 | EC002549 |
| ETIM 6.0 | EC002549 |
| ETIM 7.0 | EC002549 |
| ETIM 8.0 | EC002549 |
| UNSPSC 16.0901 | 39121528 |

Dimensional drawing (Dimensions in mm (inch))

Dimensional drawing

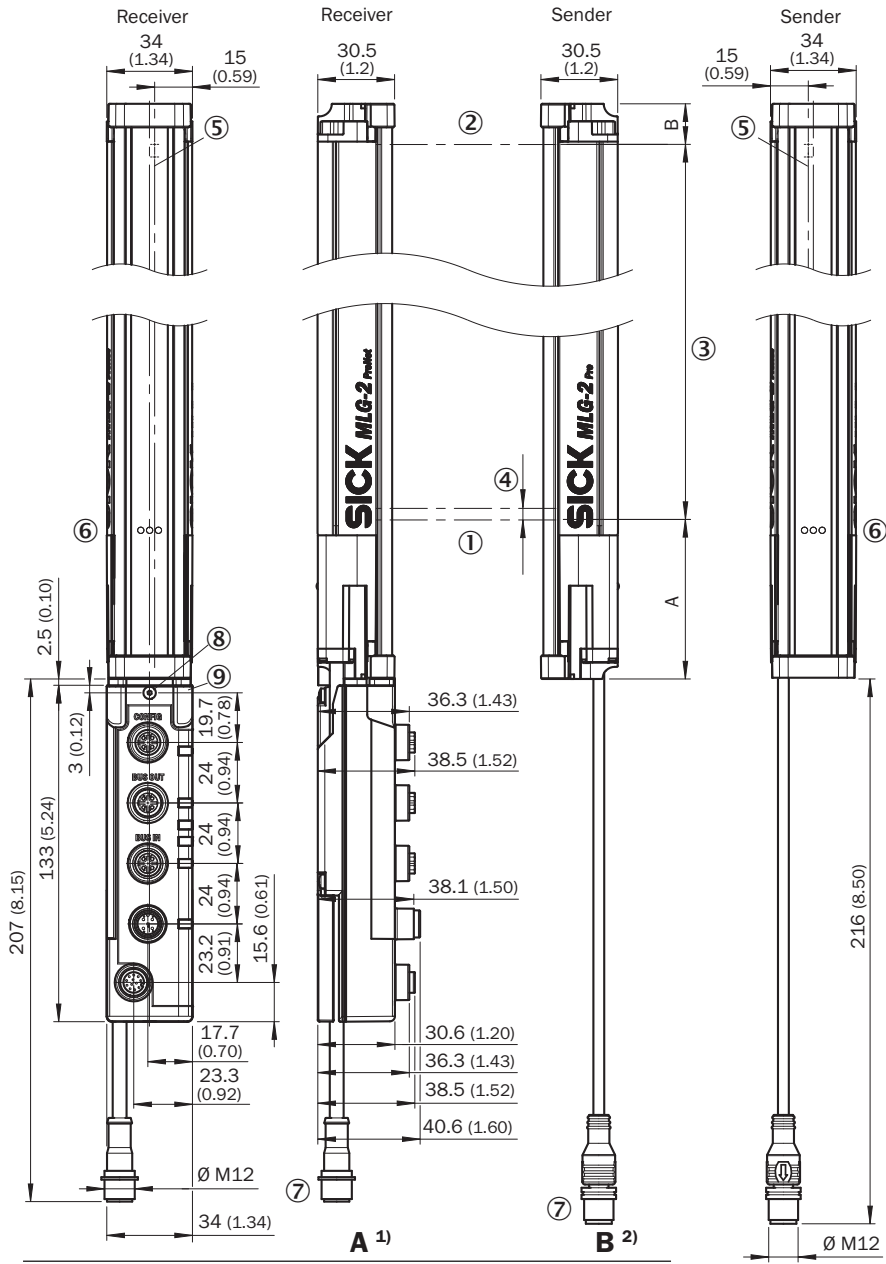

| | | |
|-------------------------------|---------------------------------------|--------------|
| Beam separation 2.5 mm | 62.25 (2.45) | 17.15 (0.68) |
| Beam separation 5 mm | 63.3 (2.49) | 16.1 (0.63) |
| Beam separation 10 mm | 68.3 (2.69) | 16.1 (0.63) |
| Beam separation 20 mm | 68.3 (2.69)/78.3 (3.08) ³⁾ | 16.1 (0.63) |
| Beam separation 25 mm | 83.3 (3.28) | 16.1 (0.63) |
| Beam separation 30 mm | 88.3 (2.69) | 16.1 (0.63) |
| Beam separation 50 mm | 108.3 (4.26) | 16.1 (0.63) |

¹⁾ Distance: MLG-2 edge - first beam

²⁾ Distance: MLG-2 edge - last beam

³⁾ MLG20x-xx40: 68.3 mm

MLG20x-xx80: 78.3 mm

- ① First beam
- ② Last beam
- ③ Detection height (see technical data)

- ④ Beam separation
- ⑤ Optical axis
- ⑥ Status indicator: green, yellow, red LEDs
- ⑦ Connection
- ⑧ Safty screw M4; turning moment 0,5 Nm
- ⑨ For thread bold M4; turning moment 0,5 Nm

Adjustments

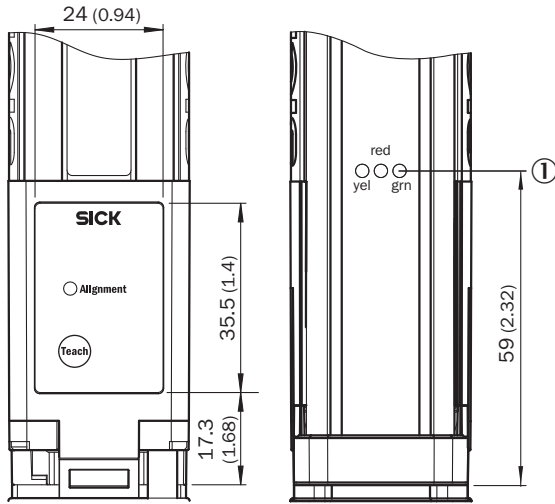

① Status indicator: green, yellow, red LEDs

Connection type and diagram

PROFINET, EtherCAT®, EtherNet/IP



① Connection to fieldbus module

Pin assignment

Ethernet



- ① Connection cable receiver (2096010)
- ② T-piece
- ③ Connection cable (2096240)
- ④ Connection receiver "DEVICE"
- ⑤ Connection cable "POWER" (2096010)
- ⑥ Ethernet Connection cable "BUS IN, BUS OUT"
- ⑦ Ethernet connection cable "CONFIG"



Connection diagram



T-piece



Recommended accessories

Other models and accessories → www.sick.com/MLG-2

| | Brief description | Type | Part no. |
|---|---|--------------------|----------|
| Distributors | | | |
|  | <ul style="list-style-type: none"> Connection type head A: Female connector, M12, 5-pin, A-coded Connection type head B: Female connector, M12, 5-pin, A-coded Connection type head C: Male connector, M12, 5-pin, A-coded Note: Male connector M12, 5-pin, straight, A-coded to 2 x female connector M12, 5-pin, straight, A-coded | SB0-02G12-SM | 6029305 |
| Plug connectors and cables | | | |
|  | <ul style="list-style-type: none"> Connection type head A: Female connector, M12, 5-pin, straight, A-coded Connection type head B: Flying leads Signal type: Sensor/actuator cable Cable: 5 m, 5-wire, PVC Description: Sensor/actuator cable, unshielded Application: Zones with chemicals | YF2A15-050VB5XLEAX | 2096240 |
|  | <ul style="list-style-type: none"> Connection type head A: Female connector, M12, 5-pin, straight, A-coded Connection type head B: Male connector, M12, 5-pin, straight, A-coded Signal type: Sensor/actuator cable Cable: 5 m, 5-wire, PUR, halogen-free Description: Sensor/actuator cable, unshielded Application: Zones with oils and lubricants, Drag chain operation, Robot | YF2A15-050UB5M2A15 | 2096010 |

| | Brief description | Type | Part no. |
|---|---|--------------------|----------|
|  | <ul style="list-style-type: none"> • Connection type head A: Male connector, M12, 4-pin, D-coded • Connection type head B: Male connector, M12, 4-pin, D-coded • Signal type: Ethernet • Cable: 5 m, 4-wire, PUR, halogen-free • Description: Ethernet, twisted pair, shielded • Permitted cross-section: ≥ 0.25 mm² • Application: Zones with oils and lubricants | YM2D24-050EA2M2D24 | 6034422 |
|  | <ul style="list-style-type: none"> • Connection type head A: Male connector, M12, 4-pin, straight, D-coded • Connection type head B: Male connector, RJ45, 4-pin, straight • Signal type: Ethernet, PROFINET • Cable: 5 m, 4-wire, PUR, halogen-free • Description: Ethernet, PROFINET, shielded • Application: Drag chain operation, Zones with oils and lubricants | YM2D24-050PN1MRJA4 | 2106184 |
| Terminal and alignment brackets | | | |
|  | Mounting bracket for external mounting of the fieldbus module, 1 × mounting bracket and 1 × M5 × 6 screw, Stainless steel V2A (1.4301) | BEF-WN-FBM-SET1 | 2082322 |

SICK AT A GLANCE

SICK is one of the leading manufacturers of intelligent sensors and sensor solutions for industrial applications. A unique range of products and services creates the perfect basis for controlling processes securely and efficiently, protecting individuals from accidents and preventing damage to the environment.

We have extensive experience in a wide range of industries and understand their processes and requirements. With intelligent sensors, we can deliver exactly what our customers need. In application centers in Europe, Asia and North America, system solutions are tested and optimized in accordance with customer specifications. All this makes us a reliable supplier and development partner.

Comprehensive services complete our offering: SICK LifeTime Services provide support throughout the machine life cycle and ensure safety and productivity.

For us, that is “Sensor Intelligence.”

WORLDWIDE PRESENCE:

Contacts and other locations –www.sick.com