



# MZ2Q-CSLPSKQ0

MZ2Q-C

SENSORS FOR C-SLOT CYLINDERS

**SICK**  
Sensor Intelligence.



### Ordering information

Type	Part no.
MZ2Q-CSLPSKQ0	1043696

Other models and accessories → [www.sick.com/MZ2Q-C](http://www.sick.com/MZ2Q-C)



### Detailed technical data

#### Features

<b>Cylinder type</b>	C-slot
<b>Preferred manufacturer slot</b>	SMC Bimba Schunk
<b>Detection zone</b>	0 mm ... 50 mm
<b>Cylinder types with adapter</b>	SMC rail ECDQ2 SMC rail CDQ2
<b>Housing length</b>	19.5 mm
<b>Switching output</b>	2 x PNP
<b>Output function</b>	NO
<b>Electrical wiring</b>	DC 4-wire
<b>Enclosure rating</b>	IP67 <sup>1)</sup>
<b>IO-Link functions</b>	Standard functions
<b>Adjustment</b>	
Teach-in control panel	Teaching in switching points 1 and 2
IO-Link	Disabling teach-in pushbutton Teaching in switching points 1 and 2 Tolerance band for switching points in 5 stages

<sup>1)</sup> According to EN 60529.

#### Mechanics/electronics

<b>Detection zone</b>	0 mm ... 50 mm
<b>Supply voltage</b>	12 V DC ... 30 V DC

<sup>1)</sup> Supply voltage  $U_B$  and constant ambient temperature  $T_a$ .

<b>Power consumption</b>	Typ. 25 mA, without load
<b>Voltage drop</b>	≤ 2.2 V
<b>Continuous current I<sub>a</sub></b>	≤ 100 mA
<b>Protection class</b>	III
<b>Hysteresis, typ.</b>	1 mT
<b>Reproducibility</b>	≤ 0.1 mT <sup>1)</sup>
<b>Reverse polarity protection</b>	Yes
<b>Short-circuit protection</b>	Yes
<b>Status indicator LED</b>	Yes
<b>Teach-in</b>	Yes
<b>Power-up pulse protection</b>	Yes
<b>Ambient operating temperature</b>	-20 °C ... +75 °C
<b>Shock and vibration resistance</b>	30 g, 11 ms / 10 ... 55 Hz, 1 mm
<b>EMC</b>	According to EN 60947-5-2
<b>Connection type</b>	Cable with connector M12, 4-pin, with knurled nuts, 0.3 m
<b>Connection type Detail</b>	
Cable diameter	Ø 2.6 mm
Bending radius	With fixed installation > 5 x cable diameter For flexible use > 10 x cable diameter
Cable outlet	Axial
<b>Material</b>	
Housing	Plastic
Cable	PUR
<b>UL File No.</b>	NRKH.E181493 & NRKH7.E181493

<sup>1)</sup> Supply voltage U<sub>B</sub> and constant ambient temperature T<sub>a</sub>.

### Safety-related parameters

<b>MTTF<sub>D</sub></b>	799 years
<b>DC<sub>avg</sub></b>	0%
<b>T<sub>M</sub> (mission time)</b>	20 years

### Communication interface

<b>Communication interface</b>	IO-Link V1.0
<b>Communication Interface detail</b>	COM2 (38,4 kBaud)
<b>Cycle time</b>	2.3 ms
<b>Process data length</b>	2 Bit
<b>Process data structure</b>	Bit 0 = switching signal Q <sub>L1</sub> Bit 1 = switching signal Q <sub>L2</sub> Bit 2 ... 7 = empty

### Classifications

<b>ECLASS 5.0</b>	27270104
<b>ECLASS 5.1.4</b>	27270104
<b>ECLASS 6.0</b>	27270104

<b>ECLASS 6.2</b>	27270104
<b>ECLASS 7.0</b>	27270104
<b>ECLASS 8.0</b>	27270104
<b>ECLASS 8.1</b>	27270104
<b>ECLASS 9.0</b>	27270104
<b>ECLASS 10.0</b>	27270104
<b>ECLASS 11.0</b>	27270104
<b>ECLASS 12.0</b>	27274301
<b>ETIM 5.0</b>	EC002544
<b>ETIM 6.0</b>	EC002544
<b>ETIM 7.0</b>	EC002544
<b>ETIM 8.0</b>	EC002544
<b>UNSPSC 16.0901</b>	39122230

### Installation note

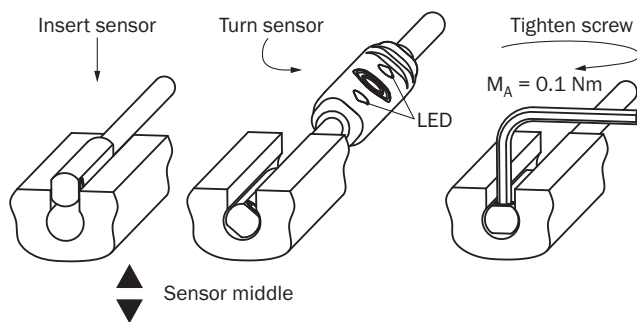

### Connection type



### Connection diagram

Cd-244

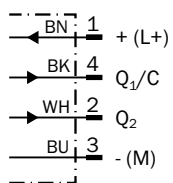

**Dimensional drawing** (Dimensions in mm (inch))

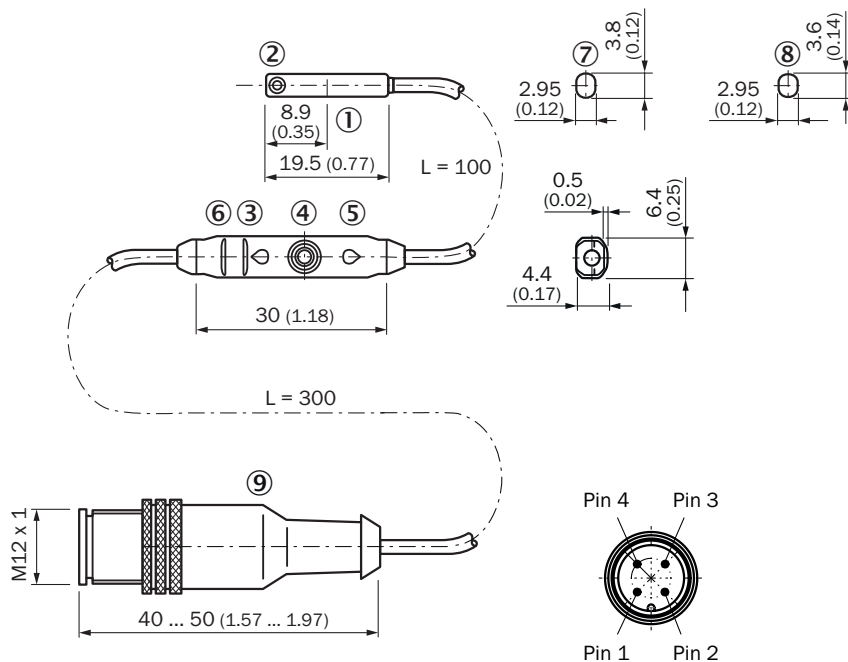

Cable with M12 male connector







- ① Center of sensor element
- ② Fixing screw SW 1.3
- ③ Display LED
- ④ Teach-in button
- ⑤ Display LED
- ⑥ Ribbing for cable ties
- ⑦ For SMC/ Bimba cylinder (MZ2Q-CSxxx)
- ⑧ For festo cylinder (MZ2Q-CFxxx)
- ⑨ Connection

**Recommended accessories**

Other models and accessories → [www.sick.com/MZ2Q-C](http://www.sick.com/MZ2Q-C)

	Brief description	Type	Part no.
<b>Fieldbus modules</b>			
	EtherCAT IO-Link Master, IO-Link V1.1, Port Class A, power supply via 7/8" cable 24 V / 8 A, fieldbus connection via M12 cable	IOLG2EC-03208R01 (IO-Link Master)	6053254
	PROFINET IO-Link Master, IO-Link V1.1, Port Class A, power supply via 7/8" cable 24 V / 8 A, fieldbus connection via M12 cable	IOLG2PN-03208R01 (IO-Link Master)	6053253
<b>Brackets for cylinder sensors</b>			
	1 piece, Mounting bracket on round body cylinder with piston diameter of 12 mm, ambient temperature min 0 °C max 50 °C, plastic, Aluminum	BEF-KHZ-RC-12	2077673
	1 piece, Mounting bracket on round body cylinder with piston diameter of 16 mm, ambient temperature min 0 °C max 50 °C, plastic, Aluminum	BEF-KHZ-RC-16	2077672

	Brief description	Type	Part no.
	1 piece, Mounting bracket on round body cylinder with piston diameter of 20 mm, ambient temperature min 0 °C max 50 °C, plastic, Aluminum	BEF-KHZ-RC-20	2077671
	1 piece, Mounting bracket on round body cylinder with piston diameter of 25 mm, ambient temperature min 0 °C max 50 °C, plastic, Aluminum	BEF-KHZ-RC-25	2077670
	1 piece, Mounting bracket on round body cylinder with piston diameter of 32 mm, ambient temperature min 0 °C max 50 °C, plastic, Aluminum	BEF-KHZ-RC-32	2077669
	1 piece, Mounting bracket on round body cylinder with piston diameter of 40 mm, ambient temperature min 0 °C max 50 °C, plastic, Aluminum	BEF-KHZ-RC-40	2077668
	1 piece, Mounting bracket on round body cylinder with piston diameter of 50 mm, ambient temperature min 0 °C max 50 °C, plastic, Aluminum	BEF-KHZ-RC-50	2077667
	1 piece, Mounting bracket on round body cylinder with piston diameter of 63 mm, ambient temperature min 0 °C max 50 °C, plastic, Aluminum	BEF-KHZ-RC-63	2077666
	1 piece, Mounting bracket on round body cylinder with piston diameter of 1 mm ... 130 mm, ambient temperature min -30 °C max 80 °C, stainless steel, Aluminum	BEF-KHZ-RC1-130	2077686
	1 piece, Mounting bracket on round body cylinder with piston diameter of 1 mm ... 25 mm, ambient temperature min -30 °C max 80 °C, stainless steel, Aluminum	BEF-KHZ-RC1-25	2077685
<b>Plug connectors and cables</b>			
	<ul style="list-style-type: none"> <li>• <b>Connection type head A:</b> Female connector, M12, 4-pin, straight, A-coded</li> <li>• <b>Connection type head B:</b> Flying leads</li> <li>• <b>Signal type:</b> Sensor/actuator cable</li> <li>• <b>Cable:</b> 2 m, 4-wire, PVC</li> <li>• <b>Description:</b> Sensor/actuator cable, unshielded</li> <li>• <b>Application:</b> Zones with chemicals</li> </ul>	YF2A14-020VB3XLEAX	2096234
	<ul style="list-style-type: none"> <li>• <b>Connection type head A:</b> Female connector, M12, 4-pin, straight, A-coded</li> <li>• <b>Connection type head B:</b> Flying leads</li> <li>• <b>Signal type:</b> Sensor/actuator cable</li> <li>• <b>Cable:</b> 5 m, 4-wire, PVC</li> <li>• <b>Description:</b> Sensor/actuator cable, unshielded</li> <li>• <b>Application:</b> Zones with chemicals</li> </ul>	YF2A14-050VB3XLEAX	2096235
	<ul style="list-style-type: none"> <li>• <b>Connection type head A:</b> Female connector, M12, 4-pin, angled, A-coded</li> <li>• <b>Connection type head B:</b> Flying leads</li> <li>• <b>Signal type:</b> Sensor/actuator cable</li> <li>• <b>Cable:</b> 2 m, 4-wire, PVC</li> <li>• <b>Description:</b> Sensor/actuator cable, unshielded</li> <li>• <b>Application:</b> Zones with chemicals</li> </ul>	YG2A14-020VB3XLEAX	2095895
	<ul style="list-style-type: none"> <li>• <b>Connection type head A:</b> Female connector, M12, 4-pin, angled, A-coded</li> <li>• <b>Connection type head B:</b> Flying leads</li> <li>• <b>Signal type:</b> Sensor/actuator cable</li> <li>• <b>Cable:</b> 5 m, 4-wire, PVC</li> <li>• <b>Description:</b> Sensor/actuator cable, unshielded</li> <li>• <b>Application:</b> Zones with chemicals</li> </ul>	YG2A14-050VB3XLEAX	2095897
	<ul style="list-style-type: none"> <li>• <b>Connection type head A:</b> Female connector, M12, 4-pin, angled, A-coded</li> <li>• <b>Connection type head B:</b> Flying leads</li> <li>• <b>Signal type:</b> Sensor/actuator cable</li> <li>• <b>Cable:</b> 2 m, 4-wire, PVC</li> <li>• <b>Description:</b> Sensor/actuator cable, unshielded, LED function display</li> <li>• <b>Note:</b> Only suitable for PNP sensors</li> <li>• <b>Application:</b> Zones with chemicals</li> </ul>	YI2A14-020VB3XLEAX	2096222
	<ul style="list-style-type: none"> <li>• <b>Connection type head A:</b> Female connector, M12, 4-pin, angled, A-coded</li> <li>• <b>Connection type head B:</b> Flying leads</li> <li>• <b>Signal type:</b> Sensor/actuator cable</li> <li>• <b>Cable:</b> 5 m, 4-wire, PVC</li> <li>• <b>Description:</b> Sensor/actuator cable, unshielded, LED function display</li> <li>• <b>Note:</b> Only suitable for PNP sensors</li> <li>• <b>Application:</b> Zones with chemicals</li> </ul>	YI2A14-050VB3XLEAX	2096223

	Brief description	Type	Part no.
	<ul style="list-style-type: none"> <li>• <b>Connection type head A:</b> Female connector, M12, 4-pin, straight</li> <li>• <b>Description:</b> Unshielded, Head A: female connector, M12, 4-pin, straight, unshielded, for power supply, for cable diameter 4 mm ... 6 mm Head B: -</li> <li>• <b>Connection systems:</b> Screw-type terminals</li> <li>• <b>Permitted cross-section:</b> ≤ 0.75 mm<sup>2</sup></li> </ul>	DOS-1204-G	6007302
	<ul style="list-style-type: none"> <li>• <b>Connection type head A:</b> Female connector, M12, 4-pin, angled</li> <li>• <b>Description:</b> Unshielded, Head A: female connector, M12, 4-pin, angled, unshielded, for power supply, for cable diameter 3 mm ... 6.5 mm Head B: -</li> <li>• <b>Connection systems:</b> Screw-type terminals</li> <li>• <b>Permitted cross-section:</b> ≤ 0.75 mm<sup>2</sup></li> </ul>	DOS-1204-W	6007303
	<ul style="list-style-type: none"> <li>• <b>Connection type head A:</b> Male connector, M12, 4-pin, straight</li> <li>• <b>Description:</b> Unshielded</li> <li>• <b>Connection systems:</b> Screw-type terminals</li> <li>• <b>Permitted cross-section:</b> ≤ 0.75 mm<sup>2</sup></li> </ul>	STE-1204-G	6009932
	<ul style="list-style-type: none"> <li>• <b>Connection type head A:</b> Male connector, M12, 4-pin, angled</li> <li>• <b>Description:</b> Unshielded</li> <li>• <b>Connection systems:</b> Screw-type terminals</li> <li>• <b>Permitted cross-section:</b> ≤ 0.75 mm<sup>2</sup></li> </ul>	STE-1204-W	6022084

### Recommended services

Additional services → [www.sick.com/MZ2Q-C](http://www.sick.com/MZ2Q-C)

	Type	Part no.
Function Block Factory		
<ul style="list-style-type: none"> <li>• <b>Description:</b> The Function Block Factory supports common programmable logic controllers (PLCs) from various manufacturers, such as Siemens, Beckhoff, Rockwell Automation and B&amp;R. More information on the FBF can be found <a _blank"="" href="https://fbf.cloud.sick.com target=">here</a>.</li> <li>• <b>Note:</b> You can configure your function block at <a _blank"="" href="https://fbf.cloud.sick.com target=">Function Block Factory</a>. As a login please use your SICK ID.</li> </ul>	Function Block Factory	On request

## SICK AT A GLANCE

SICK is one of the leading manufacturers of intelligent sensors and sensor solutions for industrial applications. A unique range of products and services creates the perfect basis for controlling processes securely and efficiently, protecting individuals from accidents and preventing damage to the environment.

We have extensive experience in a wide range of industries and understand their processes and requirements. With intelligent sensors, we can deliver exactly what our customers need. In application centers in Europe, Asia and North America, system solutions are tested and optimized in accordance with customer specifications. All this makes us a reliable supplier and development partner.

Comprehensive services complete our offering: SICK LifeTime Services provide support throughout the machine life cycle and ensure safety and productivity.

For us, that is “Sensor Intelligence.”

## WORLDWIDE PRESENCE:

Contacts and other locations –[www.sick.com](http://www.sick.com)