

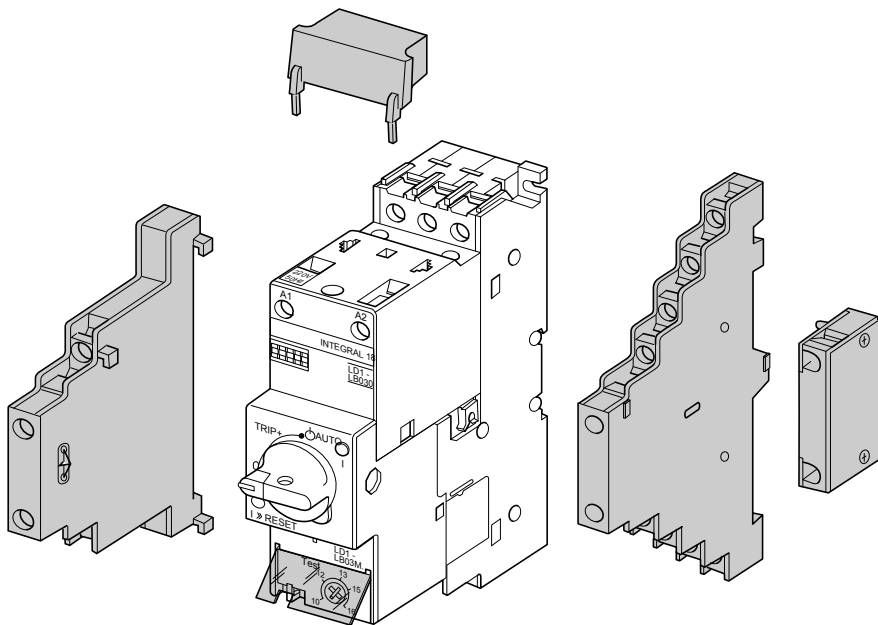







# Telemecanique integral 18

## LA1/LA9



								C	C
[mm <sup>2</sup> ]	[mm <sup>2</sup> ]	[mm <sup>2</sup> ]	[mm <sup>2</sup> ]	[mm <sup>2</sup> ]	[mm <sup>2</sup> ]	Philips	Philips	N.m	lb.in
LA1LB	1...2,5 + 1...2,5	1...2,5	1...2,5 + 1...2,5	1...2,5	1...2,5 + 1...2,5	Ø 6	2	1,2	10



The lateral add-on blocks are mounted before the module  
 Monter les additifs latéraux avant le module  
 Die seitlichen Zusatzteile vor dem Modul einbauen  
 Montar los aditivos laterales antes del módulo  
 Montare gli additivi laterali prima del modulo  
 Montar os aditivos laterais antes do módulo

# integral 18

# LA1/LA9

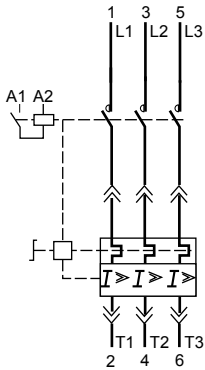

LA1-LB015

LA1-LB017

LA1-LB019

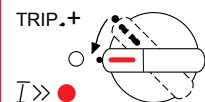
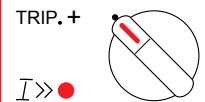
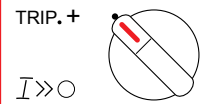
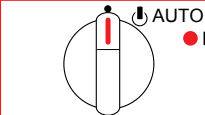
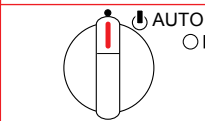
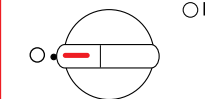
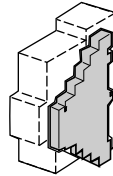
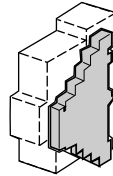
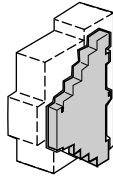

# integral 18

# LA1/LA9

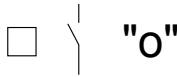
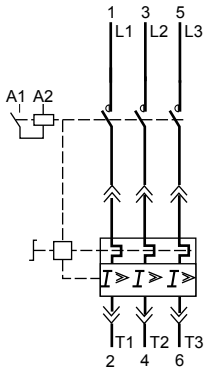

	LA1-LB001	LA1-LB031	LA1-LB0311	LA1-LB034	LA1-LB0341		
	AUTO + 0	AUTO + 0	AUTO + 0	I >	AUTO + 0	I >	
41 42	15 17 16 18	15 17 16 18	15 17 16 18	5 7 6 8	15 17 16 18	5 7 6 8	
41 42	15 17 16 18	15 17 16 18	15 17 16 18	5 7 6 8	15 17 16 18	5 7 6 8	
41 42	15 17 16 18	15 17 16 18	15 17 16 18	5 7 6 8	15 17 16 18	5 7 6 8	
TRIP. + I >> O	41 42	15 17 16 18	15 17 16 18	15 17 16 18	5 7 6 8	15 17 16 18	5 7 6 8
TRIP. + I >> ●	41 42	15 17 16 18	15 17 16 18	15 17 16 18	5 7 6 8	15 17 16 18	5 7 6 8
TRIP. + I >> ●	41 42	15 17 16 18	15 17 16 18	15 17 16 18	5 7 6 8	15 17 16 18	5 7 6 8
TRIP. + RESET	41 42	15 17 16 18	15 17 16 18	15 17 16 18	5 7 6 8	15 17 16 18	5 7 6 8

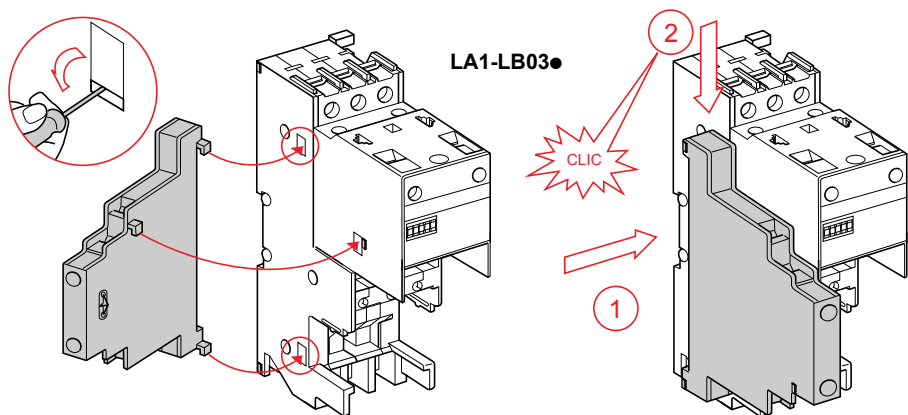
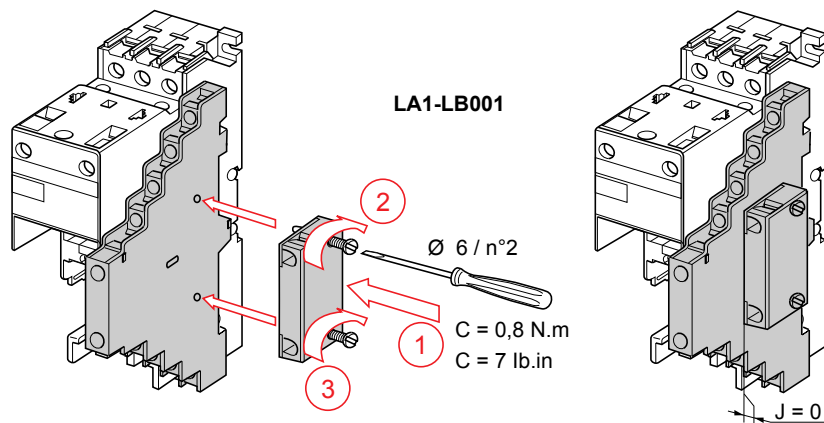
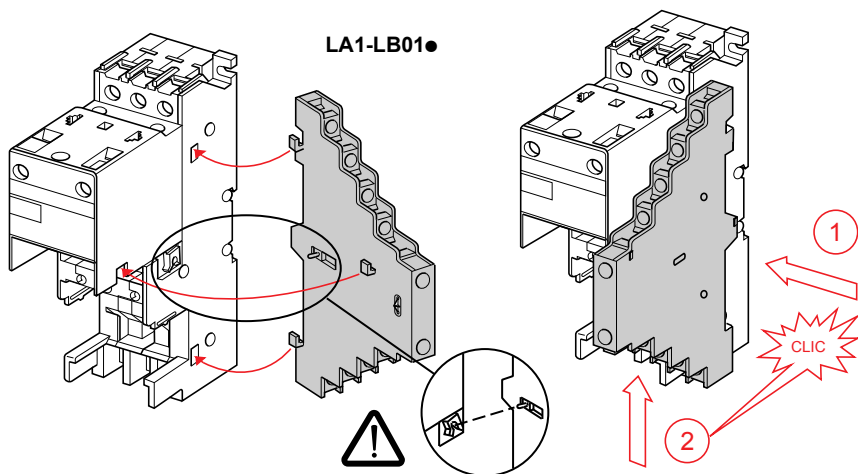

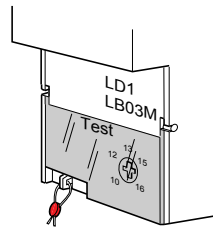
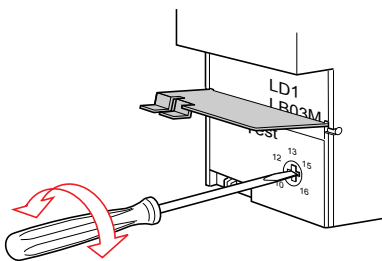
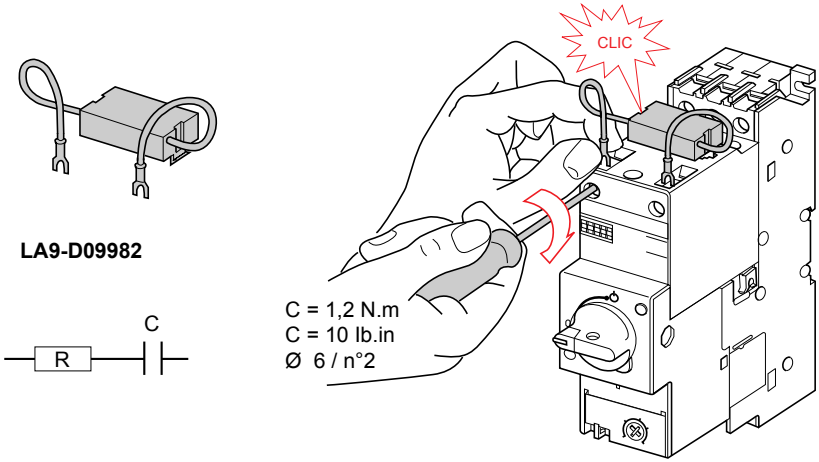
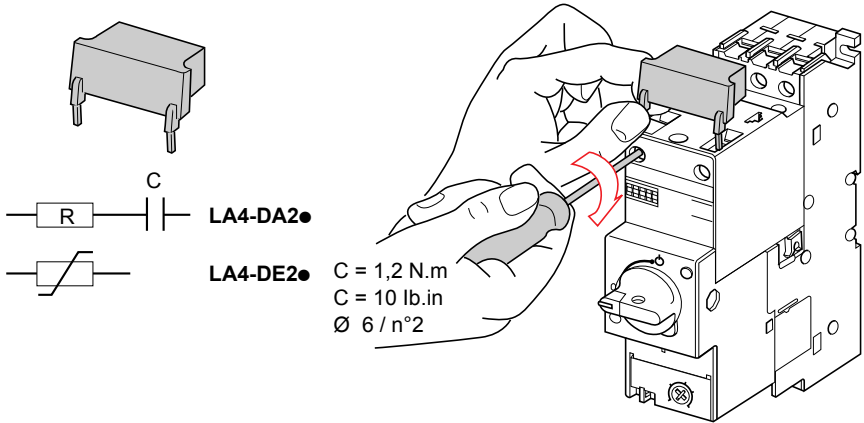

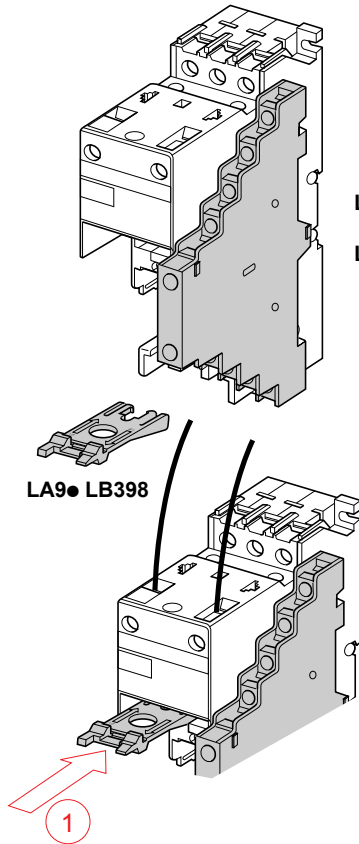

LD1●LB03●  
+  
LA1●LB01●

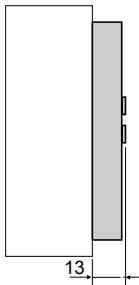
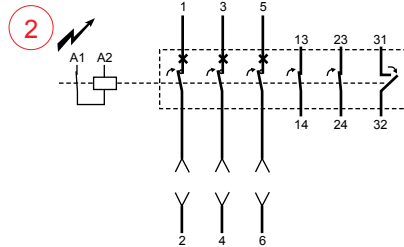
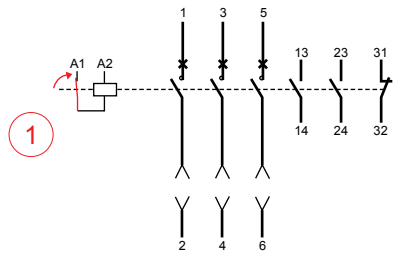
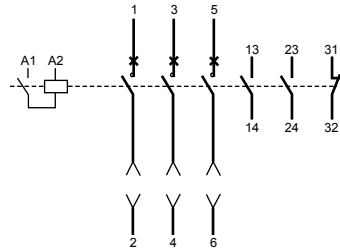

LA1-LB015  
LA1-LB017  
LA1-LB019

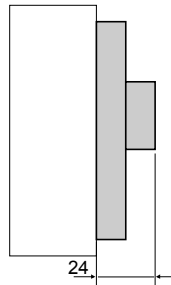

LA1-LB01●  
+  
LA1-LB001

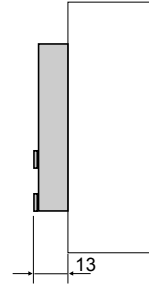

LA1-LB03●