

Distances pour la centrale IPCV1083 :

	Alim vers Centrale	Alim vers Ventouse	Bus lecteur (D+, D-, B2F)	Bouton de sortie
Câble URMET Ref : 1083/90	50 m	50 m		
Câble 1 mm ²	50 m	50 m		
HVV05-F 1,5 mm ²	100 m	100 m		
SYT1ø 0,8 mm	25 m	25 m	100m	100 m

Bus RS485 :

- Il est obligatoire d'utiliser un câble indépendant de diamètre 8/10ème.
- La distance maximum du bus série est de 800m.
- **Le bus doit être obligatoirement câblé en série.**

Distances et nombre de postes maximum pour l'interphonie :



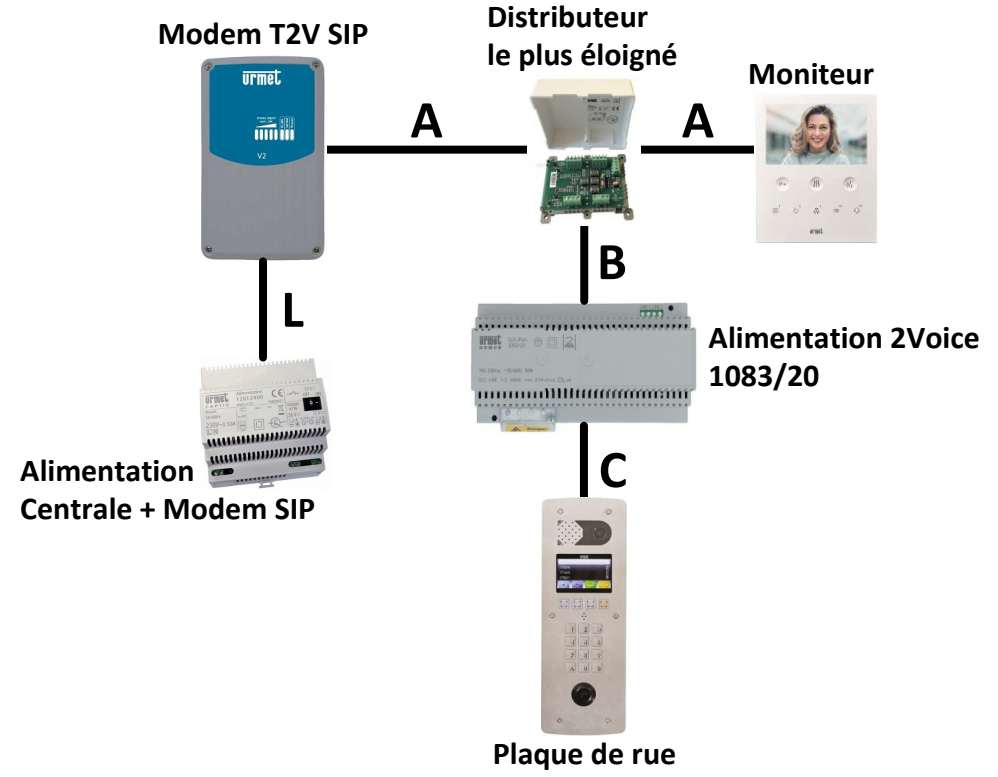
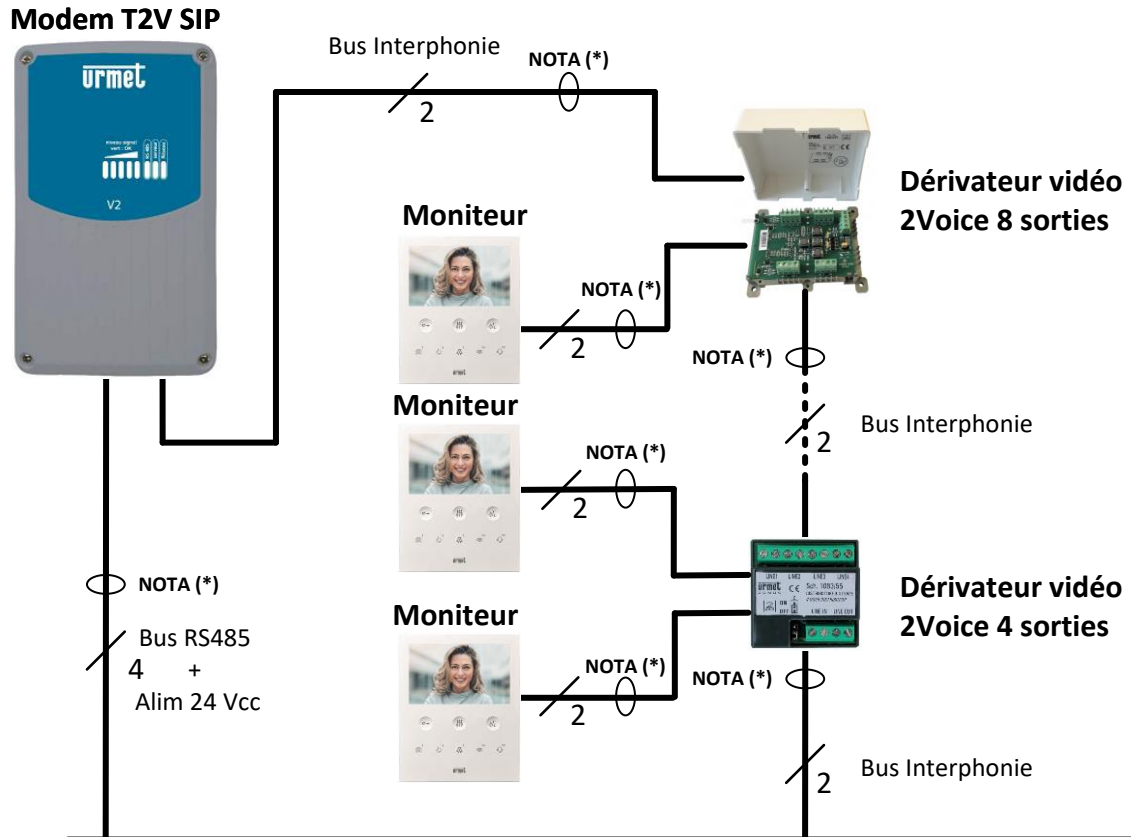



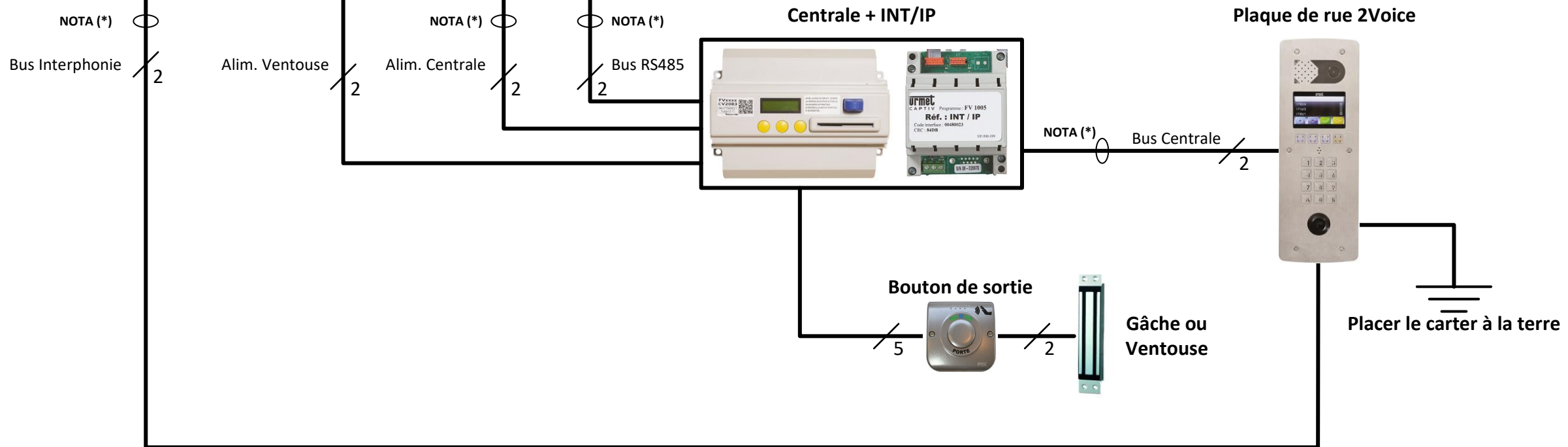
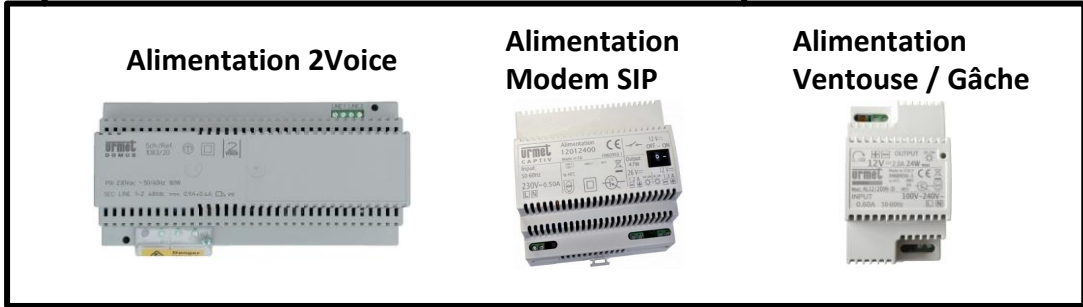





Type de câble	Nbre max de postes	Distances					Somme maximum de tous les segments A, B et C
		A	B	A+B	C	L	
Câble 2Voice	127 postes 2Voice	50 m	200 m	200 m	200 m		800 m
SYT ø 0,8 mm	64 postes 2Voice	50 m	150 m	150 m	100 m	100 m	600 m
CAT5 UTP	64 postes 2Voice	50 m	125 m	125 m	100 m		800 m
Câble 1 mm ²	32 postes 2Voice	50 m	50 m	75 m	50 m		150 m



Câble 2Voice, référence 1083/90 pour 100m et référence 1083/95 pour 500m.



Références compatibles avec le système Tel 2 Voice :

 Ref. D83/IG	 Ref. 1083/20	 Ref. IPCV2083 Ref. IPCV4083	 Ref. INT/IP	 Ref. BPZGML	 Ref. 12012400	 Ref. AL12/2DIN	 Ref. GSIP4G2V
 Ref. T25VK2	 Ref. 1083/57	 Ref. 1083/55	 Ref. 1183/4 Ref. 1183/5 Ref. 1183/7	 Ref. 1750/1 Ref. 1760/6 Ref. 1719/1			

NOTA (*) : Il est obligatoire d'utiliser un câble indépendant pour cette liaison. Le schéma n'est valable qu'avec les références produits indiquées.



1 Plaque de rue T2V SIP – IPCV2083 - 12012400

