



Current
transformers
DM5TP2000
Solid-core

Product designation

Product type designation

Type of CT

Current inputs

Primary current I_{pn} (/5)	A	2000
Operational frequency	min max	Hz Hz 50 60
Secondary output current	A	5
Overload withstand I_{pn}	%	120
Burden	cl. 0.5s cl. 0.5	VA VA 10 15

Insulations

Rated insulation voltage U_i IEC/EN	V	720
IEC rated short-time thermal current I_{th}	I_{th} for s	40...60
IEC rated dynamic current I_{dyn}	I_{th} for s	2.5
Insulation dry type		Class E

Mechanical features

Terminals type	Screw
Fixing	DIN rail or by Screw
Weight	g 900

Ambient conditions

Temperature	Operating temperature	min max	°C °C	-25 +50
	Storage temperature	min max	°C °C	-40 +80
Relative humidity			%	90
Protection degree				IP30

Dimensions

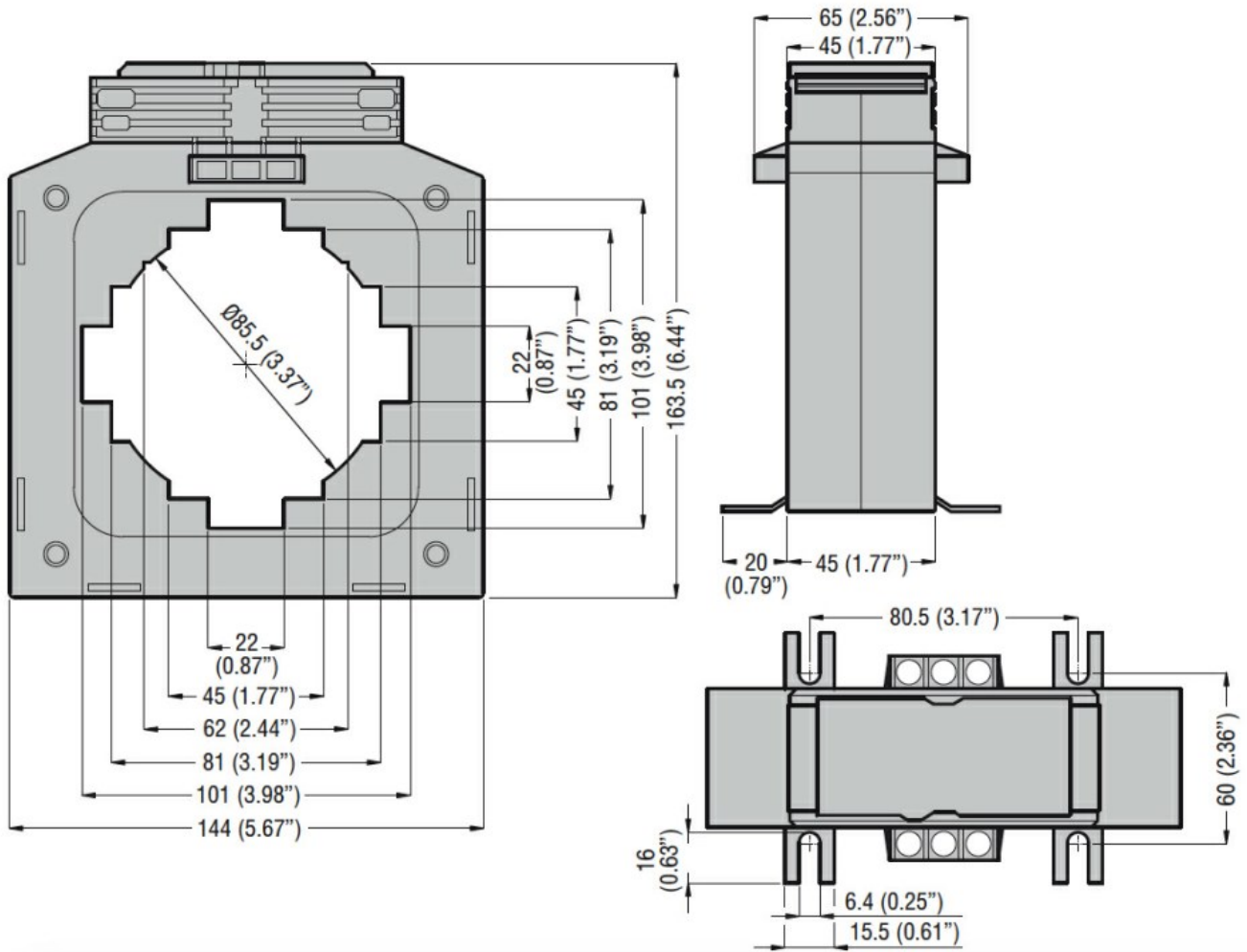

Certifications and compliance

Certifications

IEC/EN/BS 61869-1

IEC/EN/BS 61869-2

Compliance

EAC

ETIM classification

EC000066 - Power contactor, AC switching