

# HERO B

108764.20

**novalux**  
ITALIAN LIGHTING DESIGN SINCE 1948

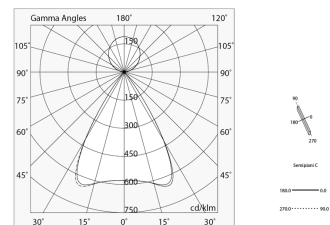
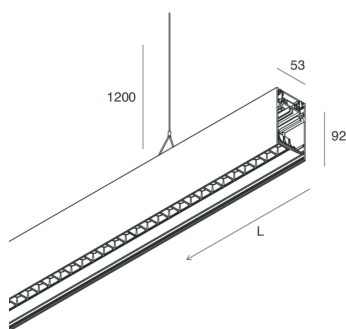
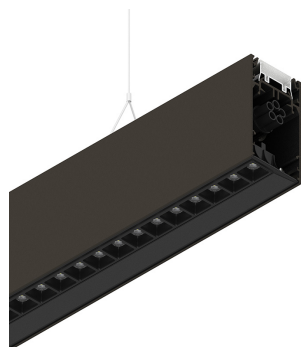

## Features

Use: Indoor  
Type of installation: SUSPENDED  
Emission: DIRECT/INDIRECT  
Optics: MICRO OPTICS  
Colour: CAFFE  
Dimming: DALI  
Emergency: NO  
L: 1428mm  
A: 53mm  
H: 92mm  
Made in: ITALY  
Warranty: 5 years  
Weight: 5kg

## Tech data

Luminaire input power: 69W  
Luminaire luminous flux: 6323lm  
Direct luminous flux: 3556lm  
Indirect luminous flux: 2767lm  
IP: 40  
Insulation class: I  
Supply voltage: 220-240V 50/60Hz  
UGR: <19  
SELV: Si

## Source

Light source: LED  
Source power: 61W  
Colour temperature: 2700K  
CRI: >90  
Colour tolerance: 3 Step MacAdam  
LED lifespan: 50000h L80 B20

## Compliance

CEI EN 60598-1:2015 + A11:2009. IEC 60598-2:2015 2-1

## Standards

Photobiological risk: RISK GROUP 0 Certified fixture in EXEMPT GROUP, in accordance with CEI EN 62471:2010-01, IEC TR 62778:2014.  
CAM edilizia: The product complies with the requirements for public buildings, ministerial decree of 23rd June 2022 n.256.

[View more product info](#)



Novalux S.r.l. via Marzabotto, 2 40050 Funo di Argelato (BO) Italy  
Tel: +39 051 860558 · Fax +39 051 6647859 · Mail: info@novalux.it · VAT number 00536541204 · novalux.com  
Company subject to the management and coordination by SLV GmbH

This technical data sheet is owned by Novalux S.r.l., all rights reserved. Novalux S.r.l. reserves the right to make changes without prior notice.

# HERO B

108764.20

**novalux**  
ITALIAN LIGHTING DESIGN SINCE 1948

## COMPLETION ACCESSORIES

---



HERO B: MOD.CIECO 250 CAF

**1087A3.20**

---



HERO B: MOD.CIECO ANG.SX 150 CAF

**1087A4.20**

---



HERO B: MOD.CIECO ANG.DX 150 CAF

**1087A5.20**

---



HERO B: MOD.CIECO 1120 CAF

**1087A6.20**

---



HERO B: MOD.CIECO 1400 CAF

**1087A7.20**

---



HERO B: MOD.CIECO 1680 CAF

**1087A8.20**

---



Novalux S.r.l. via Marzabotto, 2 40050 Funo di Argelato (BO) Italy  
Tel: +39 051 860558 · Fax +39 051 6647859 · Mail: info@novalux.it · VAT number 00536541204 · novalux.com  
Company subject to the management and coordination by SLV GmbH

This technical data sheet is owned by Novalux S.r.l., all rights reserved. Novalux S.r.l. reserves the right to make changes without prior notice.

# HERO B

108764.20

**novalux**  
ITALIAN LIGHTING DESIGN SINCE 1948

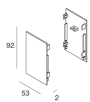

HERO B: COPPIA TESTATE CAF

**1087B1.20**

## MOUNTING ACCESSORIES



HERO B: KIT COPPIA CAVI SOSP. 5 M

**1087B2.99**



KIT ALIMENTAZIONE L1200 5P BIA

**108921.01**



KIT ALIMENTAZIONE L1200 5P CAF

**108921.20**



KIT ALIMENTAZIONE L3000 5P BIA

**108922.01**



KIT ALIMENTAZIONE L3000 5P CAF

**108922.20**



Novalux S.r.l. via Marzabotto, 2 40050 Funo di Argelato (BO) Italy  
Tel: +39 051 860558 · Fax +39 051 6647859 · Mail: info@novalux.it · VAT number 00536541204 · novalux.com  
Company subject to the management and coordination by SLV GmbH

This technical data sheet is owned by Novalux S.r.l., all rights reserved. Novalux S.r.l. reserves the right to make changes without prior notice.