



# DFS60B-S1NL01024

DFS60

INCREMENTAL ENCODERS

**SICK**  
Sensor Intelligence.



Illustration may differ



### Ordering information

Type	Part no.
DFS60B-S1NL01024	1127184

Other models and accessories → [www.sick.com/DFS60](http://www.sick.com/DFS60)

### Detailed technical data

#### Performance

<b>Sine/cosine periods per revolution</b>	1,024
<b>Measuring step</b>	90°, electric/pulses per revolution
<b>Measuring step deviation at binary number of lines</b>	± 0.008°
<b>Error limits</b>	± 0.05°

#### Interfaces

<b>Communication interface</b>	Incremental
<b>Communication Interface detail</b>	Sin/Cos <sup>1)</sup>
<b>Number of signal channels</b>	6-channel
<b>Initialization time</b>	40 ms
<b>Output frequency</b>	≤ 200 kHz
<b>Operating current</b>	40 mA (without load)
<b>Load resistance</b>	≤ 120 Ω

<sup>1)</sup> 1.0 V<sub>SS</sub> (differential).

#### Electrical data

<b>Connection type</b>	Cable, 8-wire, universal, 3 m <sup>1)</sup>
<b>Supply voltage</b>	4.5 ... 5.5 V
<b>Reference signal, number</b>	1
<b>Reference signal, position</b>	90°, electronically, gated with Sinus and Cosinus
<b>Short-circuit protection of the outputs</b>	✓ <sup>2)</sup>
<b>MTTFd: mean time to dangerous failure</b>	300 years (EN ISO 13849-1) <sup>3)</sup>

<sup>1)</sup> The universal cable connection is positioned so that it is possible to lay it without bends in a radial or axial direction.

<sup>2)</sup> Short-circuit opposite to another channel, US or GND permissible for maximum 30 s.

<sup>3)</sup> This product is a standard product and does not constitute a safety component as defined in the Machinery Directive. Calculation based on nominal load of components, average ambient temperature 40°C, frequency of use 8760 h/a. All electronic failures are considered hazardous. For more information, see document no. 8015532.

#### Mechanical data

<b>Mechanical design</b>	Solid shaft, Servo flange
--------------------------	---------------------------

<sup>1)</sup> Allow for self-heating of 3.3 K per 1,000 rpm when designing the operating temperature range.

<b>Shaft diameter</b>	6 mm
<b>Shaft length</b>	10 mm
<b>Weight</b>	+ 0.3 kg
<b>Shaft material</b>	Stainless steel
<b>Flange material</b>	Aluminum
<b>Housing material</b>	Aluminum die cast
<b>Start up torque</b>	0.5 Ncm (+20 °C)
<b>Operating torque</b>	0.3 Ncm (+20 °C)
<b>Permissible shaft loading</b>	80 N (radial) 40 N (axial)
<b>Operating speed</b>	≤ 9,000 min <sup>-1</sup> <sup>1)</sup>
<b>Moment of inertia of the rotor</b>	6.2 gcm <sup>2</sup>
<b>Bearing lifetime</b>	3.6 x 10 <sup>10</sup> revolutions
<b>Angular acceleration</b>	≤ 500,000 rad/s <sup>2</sup>

<sup>1)</sup> Allow for self-heating of 3.3 K per 1,000 rpm when designing the operating temperature range.

## Ambient data

<b>EMC</b>	According to EN 61000-6-2 and EN 61000-6-3
<b>Enclosure rating</b>	IP67, housing side, cable connection (IEC 60529) IP65, shaft side (IEC 60529)
<b>Permissible relative humidity</b>	90 % (Condensation not permitted)
<b>Operating temperature range</b>	-40 °C ... +100 °C <sup>1)</sup> -30 °C ... +100 °C <sup>2)</sup>
<b>Storage temperature range</b>	-40 °C ... +100 °C, without package
<b>Resistance to shocks</b>	70 g, 6 ms (EN 60068-2-27)
<b>Resistance to vibration</b>	30 g, 10 Hz ... 2,000 Hz (EN 60068-2-6)

<sup>1)</sup> Stationary position of the cable.

<sup>2)</sup> Flexible position of the cable.

## Classifications

<b>eCl@ss 5.0</b>	27270501
<b>eCl@ss 5.1.4</b>	27270501
<b>eCl@ss 6.0</b>	27270590
<b>eCl@ss 6.2</b>	27270590
<b>eCl@ss 7.0</b>	27270501
<b>eCl@ss 8.0</b>	27270501
<b>eCl@ss 8.1</b>	27270501
<b>eCl@ss 9.0</b>	27270501
<b>eCl@ss 10.0</b>	27270501
<b>eCl@ss 11.0</b>	27270501
<b>eCl@ss 12.0</b>	27270501
<b>ETIM 5.0</b>	EC001486
<b>ETIM 6.0</b>	EC001486

<b>ETIM 7.0</b>	EC001486
<b>ETIM 8.0</b>	EC001486
<b>UNSPSC 16.0901</b>	41112113

### Dimensional drawing (Dimensions in mm (inch))

Servo flange, cable

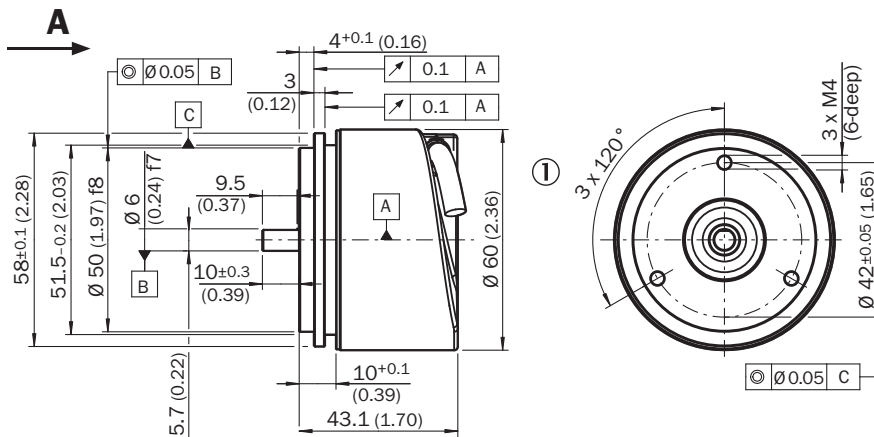

General tolerances according to DIN ISO 2768-mk

① Cable diameter = 5.6 mm +/- 0.2 mm bend radius = 30 mm

### Attachment specifications

Mounting requirements for half-shell servo clamp

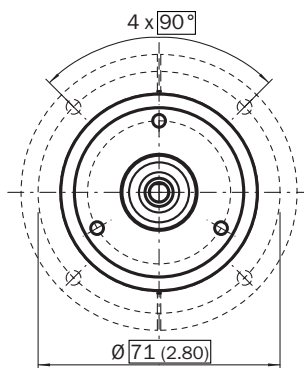

All dimensions in mm (inch)

Part no. 2029165

Mounting requirements for small servo clamp

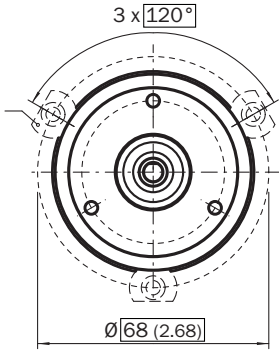

All dimensions in mm (inch)

Part no. 2029166

PIN assignment

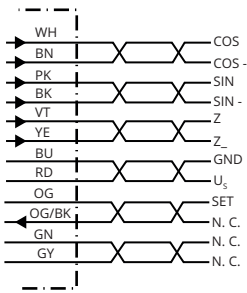

Diagrams

Signal SIN/COS before differential generation

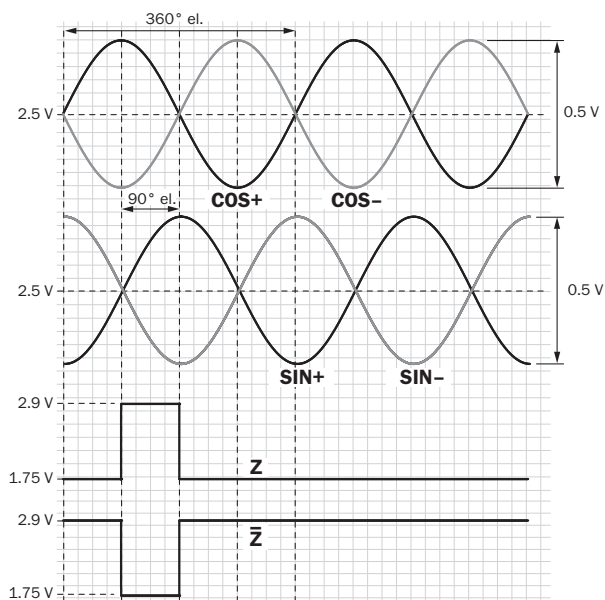

For clockwise shaft rotation, looking in direction "A" (see dimensional drawing)

Signal	Interface signals	Signal before differential generation At load 120 Ω	Signal offset
+ SIN - SIN + COS - COS	Analog, differential	0,5 V <sub>SS</sub> ± 20 %	2,5 V ± 10 %
Z Z <sub>-</sub>	Digital differential	Low: 1,75 V ± 15 %, High: 2,90 V ± 15 %	

Signal SIN/COS after differential generation

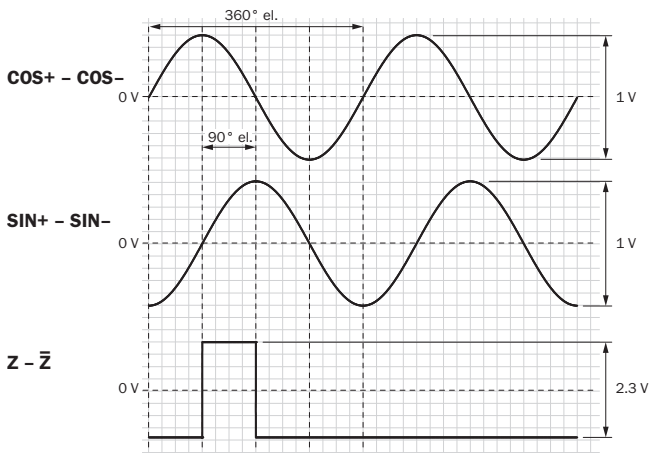

For clockwise shaft rotation, looking in direction "A" (see dimensional drawing)





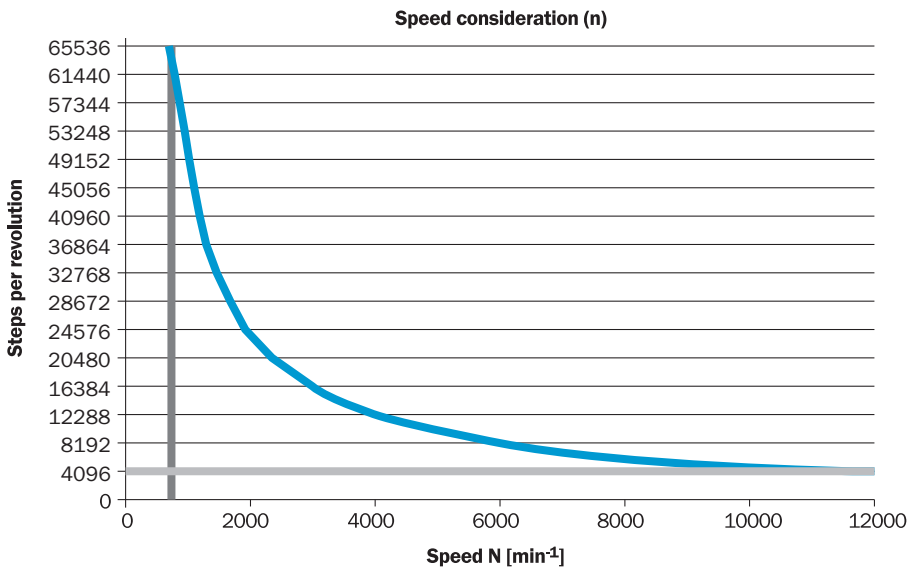



Supply voltage	Output
4,5 V ... 5,5 V	Sin/Cos 1.0 V <sub>pp</sub>

Maximum revolution range



## Recommended accessories

Other models and accessories → [www.sick.com/DFS60](http://www.sick.com/DFS60)

	Brief description	Type	Part no.
<b>Other mounting accessories</b>			
	Aluminium measuring wheel with O-ring (NBR70) for 6 mm solid shaft, circumference 200 mm	BEF-MR006020R	2055222
	Measuring wheel with O-ring (NBR70) for 6 mm solid shaft, circumference 300 mm	BEF-MR006030R	2055634
	Aluminium measuring wheel with O-ring (NBR70) for 6 mm solid shaft, circumference 500 mm	BEF-MR006050R	2055225
	Aluminum measuring wheel with cross-knurled surface for 6 mm solid shaft, circumference 200 mm	BEF-MR06200AK	4084745
	Aluminum measuring wheel with smooth polyurethane surface for 6 mm solid shaft, circumference 200 mm	BEF-MR06200AP	4084746
	Aluminum measuring wheel with ridged polyurethane surface for 6 mm solid shaft, circumference 200 mm	BEF-MR06200APG	4084748
	Aluminum measuring wheel with studded polyurethane surface for 6 mm solid shaft, circumference 200 mm	BEF-MR06200APN	4084747
	Mounting bell for encoder with servo flange, 50 mm spigot, mounting kit included	BEF-MG-50	5312987
	Bearing block for servo and face mount flange encoder. The heavy-duty bearing block is used to absorb very large radial and axial shaft loads. Particularly when using belt pulleys, chain sprockets, friction wheels. Operating speed max. 4,000 rpm <sup>-1</sup> , axial shaft load 150 N, radial shaft load 250 N, bearing service life 3.6 x 10 <sup>9</sup> revolutions	BEF-FA-LB1210	2044591
	Mounting kit for servo flange encoder on the bearing block, 1 bar coupling SKPS 1520 06/06 1 hexagon socket wrench SW1.5 DIN 911, 3 mounting eccentric BEMN 1242 49 3 screws M4 x 10 DIN 912, 1 hexagon socket wrench SW3 DIN 911, 1 bar coupling SKPS 1520 06/06 1 hexagon socket wrench SW1.5 DIN 911, 3 mounting eccentric BEMN 1242 49 3 screws M4 x 10 DIN 912, 1 hexagon socket wrench SW3 DIN 911	BEF-MK-LB	5320872
	Servo clamps, large, for servo flange (clamps, eccentric fastener), 3 pcs, without mounting material, without mounting hardware	BEF-WK-SF	2029166
<b>Plug connectors and cables</b>			
	Head A: female connector, JST, 8-pin, straight Head B: Flying leads Cable: Incremental, SSI, PUR, halogen-free, shielded, 5 m	DOL-0J08-G05MAA3	2046876
	Head A: female connector, JST, 8-pin, straight Head B: Flying leads Cable: Incremental, SSI, PUR, halogen-free, shielded, 0.5 m	DOL-0J08-G0M5AA3	2046873
	Head A: female connector, JST, 8-pin, straight Head B: Flying leads Cable: Incremental, SSI, PUR, halogen-free, shielded, 10 m	DOL-0J08-G10MAA3	2046877
	Head A: female connector, JST, 8-pin, straight Head B: Flying leads Cable: SSI, Incremental, PUR, halogen-free, shielded, 1.5 m	DOL-0J08-G1M5AA6	2048590
	Head A: female connector, JST, 8-pin, straight Head B: Flying leads Cable: SSI, Incremental, PUR, halogen-free, shielded, 3 m	DOL-0J08-G3M0AA6	2048591

	Brief description	Type	Part no.
	Head A: female connector, JST, 8-pin, straight Head B: male connector, M23, 12-pin, straight Cable: Incremental, PUR, halogen-free, shielded, 1 m	STL-2312-G01MAA3	2061622
	Head A: female connector, JST, 8-pin, straight Head B: male connector, M23, 12-pin, straight Cable: Incremental, PUR, halogen-free, shielded, 2 m	STL-2312-G02MAA3	2061504
	Head A: female connector, JST, 8-pin, straight Head B: male connector, M23, 12-pin, straight Cable: Incremental, PUR, halogen-free, shielded, 0.35 m	STL-2312-GM35AA3	2061621
	Head A: male connector, M12, 8-pin, straight, A-coded Cable: Incremental, shielded	STE-1208-GA01	6044892
	Head A: male connector, M23, 12-pin, straight Cable: HIPERFACE®, SSI, Incremental, shielded	STE-2312-G01	2077273
		STE-2312-GX	6028548
<b>Shaft adaptation</b>			
	Bellows coupling, shaft diameter 6 mm / 6 mm, maximum shaft offset: radial $\pm 0.25$ mm, axial $\pm 0.4$ mm, angular $\pm 4^\circ$ ; max. speed 10,000 rpm, $-30^\circ\text{C}$ to $+120^\circ\text{C}$ , max. torque 120 Ncm; material: stainless steel bellows, aluminum hub	KUP-0606-B	5312981
	Cross-slotted coupling, shaft diameter 6 mm / 6 mm, maximum shaft offset: radial $\pm 0.3$ mm, axial $\pm 0.2$ mm, angle $\pm 3^\circ$ ; max. speed 10,000 rpm, $-10^\circ$ to $+80^\circ\text{C}$ , max. torque 80 Ncm; material: fiber-glass reinforced polyamide, aluminum hub	KUP-0606-S	2056406
	Bar coupling, shaft diameter 6 mm / 8 mm, maximum shaft offset radial $\pm 0.3$ mm, axial $\pm 0.2$ mm, angle $\pm 3^\circ$ , max. speed 10,000 rpm, torsion spring rigidity 38 Nm/wheel; material: fiber-glass reinforced polyamide, aluminum hub	KUP-0608-S	5314179
	Bellows coupling, shaft diameter 6 mm / 10 mm, maximum shaft offset: radial $\pm 0.25$ mm, axial $\pm 0.4$ mm, angular $\pm 4^\circ$ ; max. speed 10,000 rpm, $-30^\circ\text{C}$ to $+120^\circ\text{C}$ , max. torque 120 Ncm; material: stainless steel bellows, aluminum hub	KUP-0610-B	5312982
	Double loop coupling, shaft diameter 6 mm / 10 mm, max. shaft offset: radially $\pm 2.5$ mm, axially $\pm 3$ mm, angle $\pm 10$ degrees; max. speed 3.000 rpm, $-30$ to $+80$ degrees Celsius, torsional spring stiffness of 25 Nm/rad	KUP-0610-D	5326697
	Spring washer coupling, shaft diameter 6 mm / 10 mm, Maximum shaft offset: radial $\pm 0.3$ mm, axial $\pm 0.4$ mm, angular $\pm 2.5^\circ$ ; max. speed 12,000 rpm, $-10^\circ$ to $+80^\circ\text{C}$ , max. torque 60 Ncm; material: aluminum flange, glass fiber-reinforced polyamide membrane and hardened steel coupling pin	KUP-0610-F	5312985
	Claw coupling, shaft diameter 6 mm / 10 mm, damping element 80 shore blue, maximum shaft offset: radial $\pm 0.22$ mm, axial $\pm 1$ mm angular $\pm 1.3^\circ$ , max. speed 19,000 rpm, angle of twist max. $10^\circ$ , $-30^\circ\text{C}$ to $+80^\circ\text{C}$ , max. torque 800 Ncm, tightening torque of screws: ISO 4029 150 Ncm, material: aluminum flange, damping element: polyurethane	KUP-0610-J	2127056
	Bar coupling, shaft diameter 6 mm / 10 mm, max. shaft offset: radial $\pm 0.3$ mm, axial $\pm 0.3$ mm, angular $\pm 3^\circ$ ; max. speed 10.000 rpm, $-10^\circ$ to $+80^\circ\text{C}$ , max. torque: 80 Ncm, material: fiber-glass reinforced polyamide, aluminum hub	KUP-0610-S	2056407



## SICK AT A GLANCE

SICK is one of the leading manufacturers of intelligent sensors and sensor solutions for industrial applications. A unique range of products and services creates the perfect basis for controlling processes securely and efficiently, protecting individuals from accidents and preventing damage to the environment.

We have extensive experience in a wide range of industries and understand their processes and requirements. With intelligent sensors, we can deliver exactly what our customers need. In application centers in Europe, Asia and North America, system solutions are tested and optimized in accordance with customer specifications. All this makes us a reliable supplier and development partner.

Comprehensive services complete our offering: SICK LifeTime Services provide support throughout the machine life cycle and ensure safety and productivity.

For us, that is “Sensor Intelligence.”

## WORLDWIDE PRESENCE:

Contacts and other locations –[www.sick.com](http://www.sick.com)