

# GHOST EVO

104044.01

**novalux**  
ITALIAN LIGHTING DESIGN SINCE 1948

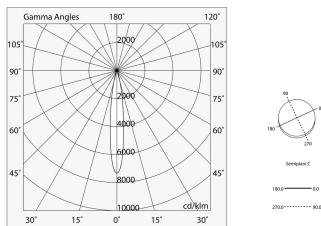
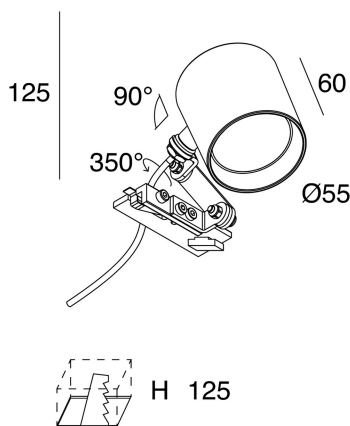

## Features

Use: Indoor  
Emission: ADJUSTABLE  
Optics: SPOT  
Beam: 14°  
Colour: WHITE  
Dimming: WITH ACCESSORY  
Emergency: NO  
H: 65mm  
ø: Ø63  
Made in: ITALY  
Warranty: 5 years  
Weight: 0.6kg

## Tech data

Luminaire luminous flux: 1055lm  
IP: 20  
Insulation class: III  
Supply voltage: DC 350 mA

## Source

Light source: LED  
Source power: 12W  
Source luminous flux: 1375lm  
Colour temperature: 3000K  
CRI: >90  
LED lifespan: 50000h L80 B20

## Compliance

CEI EN 60598-1:2015 + A11:2009. IEC 60598-2:2015 2-1, 2-2

## Standards

Photobiological risk: RISK GROUP 1 Certified fixture in RISK GROUP 1 (Low Risk)-The fixture does not pose a hazard due to normal behavioral limitations on exposure - in accordance with CEI EN 62471:2010-01, IEC TR 62778:2014.

CAM edilizia: The product complies with the requirements for public buildings, ministerial decree of 23rd June 2022 n.256.

[View more product info](#)



Novalux S.r.l. via Marzabotto, 2 40050 Funo di Argelato (BO) Italy  
Tel: +39 051 860558 · Fax +39 051 6647859 · Mail: info@novalux.it · VAT number 00536541204 · novalux.com  
Company subject to the management and coordination by SLV GmbH

This technical data sheet is owned by Novalux S.r.l., all rights reserved. Novalux S.r.l. reserves the right to make changes without prior notice.

# GHOST EVO

104044.01

**novalux**  
ITALIAN LIGHTING DESIGN SINCE 1948

## COMPLETION ACCESSORIES

---



GALA: HONEYCOMB D.50

**1018A4.02**

## ELECTRICAL ACCESSORIES

---

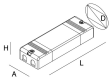

ALIM. LED 350MA - 27W - IP20

**104049.99**

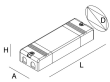

ALIM. LED MAX 18W 350MA

**101326.99**

## DIMMABLE ACCESSORIES

---

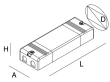

ALIM. LED 25W 350MA/2-50V DALI/PUSH

**101333.99**

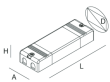

ALIM. LED DALI/PUSH 21W/350MA 20-60V

**101323.99**



Novalux S.r.l. via Marzabotto, 2 40050 Funo di Argelato (BO) Italy  
Tel: +39 051 860558 · Fax +39 051 6647859 · Mail: info@novalux.it · VAT number 00536541204 · novalux.com  
Company subject to the management and coordination by SLV GmbH

This technical data sheet is owned by Novalux S.r.l., all rights reserved. Novalux S.r.l. reserves the right to make changes without prior notice.