



LFP1100-G1NMB

LFP Inox

TDR LEVEL SENSOR

SICK
Sensor Intelligence.



Illustration may differ



Ordering information

Type	Part no.
LFP1100-G1NMB	1052076

Other models and accessories → www.sick.com/LFP_Inox

Detailed technical data

Features

Medium	Fluids
Measurement	Switch, Continuous
Design	Standard
Probe length	1,100 mm
Process pressure	-1 bar ... 16 bar
Process temperature	-20 °C ... +150 °C
UL approval	✓
RoHS certificate	✓
IO-Link	✓
EHEDG approval	✓

Performance

Accuracy of sensor element	± 5 mm
Reproducibility	≤ 2 mm
Resolution	1 mm
Response time	< 400 ms ¹⁾
Dielectricity constant	≥ 5 for rod probe ≥ 1.8 with coaxial tube
Conductivity	No limitation
Deactivated area at process connection	25 mm ²⁾
Deactivated area at end of probe	≥ 10 mm ³⁾
MTTF	194.3 years (EN ISO 13849-1)

¹⁾ Dependent on measuring mode (high speed < 400 ms, high accuracy < 2,800 ms).

²⁾ With parameterized container with water under reference conditions, otherwise 40 mm.

³⁾ With water under reference conditions.

Display	✓
----------------	---

¹⁾ Dependent on measuring mode (high speed < 400 ms, high accuracy < 2,800 ms).

²⁾ With parameterized container with water under reference conditions, otherwise 40 mm.

³⁾ With water under reference conditions.

Electronics

Supply voltage	12 V DC ... 30 V DC ¹⁾
Power consumption	≤ 75 mA at 24 V DC without output load
Initialization time	≤ 2 s
Protection class	III
Connection type	Round connector M12 x 1, 5-pin
Output signal	1 x PNP + 1 x PNP/NPN + 4 mA ... 20 mA / 0 V ... 10 V
Output load	4 mA ... 20 mA < 500 Ohm at Uv > 13,5 V, 4 mA ... 20 mA < 400 Ohm at Uv > 12 V, 0 V ... 10 V > 750 Ohm at Uv 14 ≥ V
Hysteresis	Min. 2 mm, free adjustable
Output current	< 100 mA
Inductive load	< 1 H
Capacitive load	< 100 nF
Enclosure rating	IP67 / 69: EN 60529
Temperature drift	< 0.1 mm/K
Lower signal level	3.8 mA ... 4 mA, 0 V
Upper signal level	20 mA ... 20.5 mA, 10.5 V
EMC	EN 61326-2-3, 2014/30/EU

¹⁾ All connections are polarity protected. All outputs are overload and short-circuit protected.

Mechanics

Wetted parts	316L (Ra ≤ 0,8 μm), PEEK
Process connection	G ¾ A
Housing material	303
Housing design	With viewing window made from PMMA (acrylic glass)
Max. probe load	≤ 6 Nm

Ambient data

Ambient operating temperature	-20 °C ... +60 °C
Ambient temperature, storage	-40 °C ... +80 °C
Outdoor use	Only with weather hood

Classifications

ECLASS 5.0	27200513
ECLASS 5.1.4	27200513
ECLASS 6.0	27200513
ECLASS 6.2	27200513
ECLASS 7.0	27200513
ECLASS 8.0	27200513
ECLASS 8.1	27200513

ECLASS 9.0	27200513
ECLASS 10.0	27200513
ECLASS 11.0	27200513
ECLASS 12.0	27200513
ETIM 5.0	EC001447
ETIM 6.0	EC001447
ETIM 7.0	EC001447
ETIM 8.0	EC001447
UNSPSC 16.0901	41113710

Type code

Type code

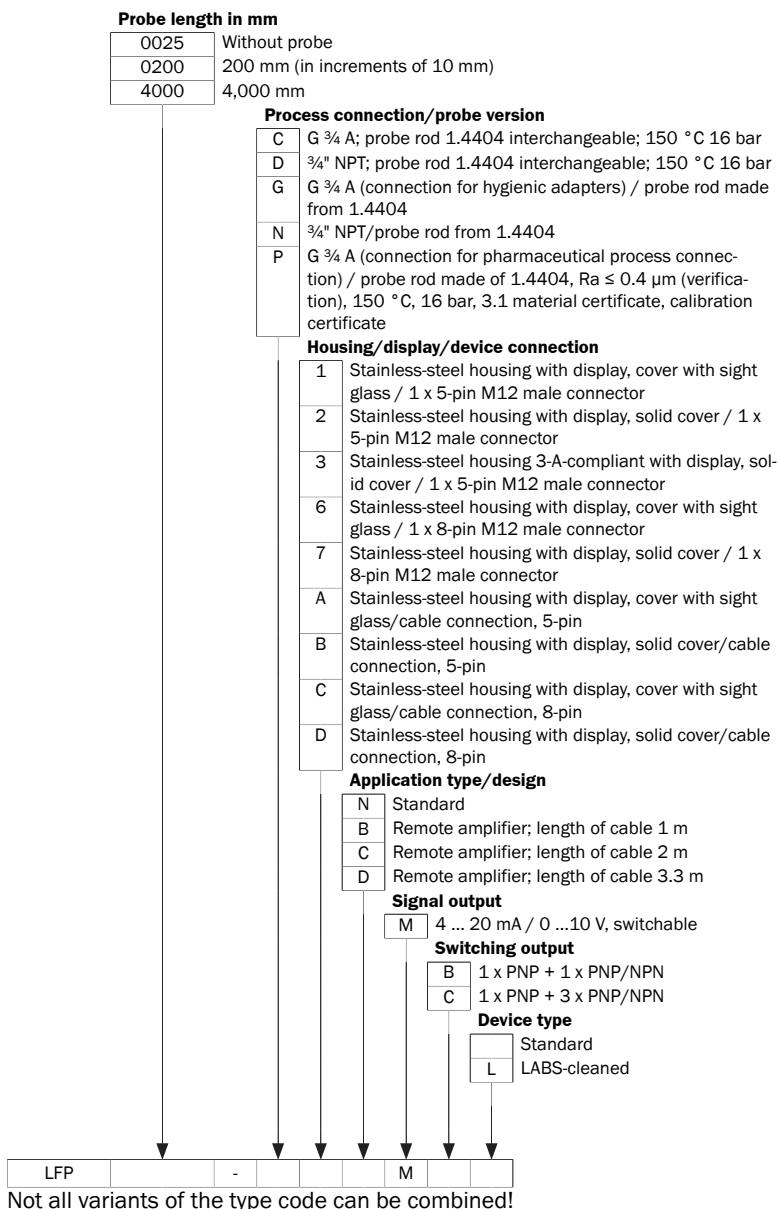

Dependence between length of coaxial cable and probe length

Length of coaxial cable (mm)	Max. probe length (mm) - foam mode deactivated	Max. probe length (mm) - foam mode active
1000	4,000	2000
2000	3,000	1500
3300	1,000	500

Dimensional drawing (Dimensions in mm (inch))



Connection type



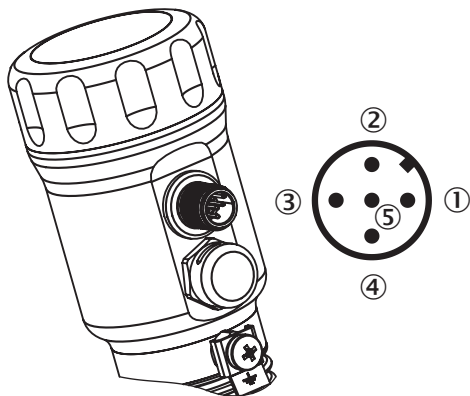

5-pole M12 Connector







- ① L⁺: Supply voltage, brown
- ② Q_A: Analog current-/voltage output, white
- ③ M: Ground, reference ground for current-/voltage output, blue
- ④ C/Q₁: Switching output 1, PNP/IO-Link-communication, black
- ⑤ Q₂: Switching output 2, PNP/NPN, grey

Recommended accessories

Other models and accessories → www.sick.com/LFP_Inox

	Brief description	Type	Part no.
Hardware			
	Weather protection cover for LFP Inox, material: 304	APR-WP-LFP001-0001	2069530
Spare parts			
	Cover closed, material 1.4305	Cover closed	2067269
	Cover for LFP Inox with inspection window, material 1.4305 and PMMA	Cover with front screen	2067267
Device protection (mechanical)			
	Coaxial tube for LFP with process connection G 3/4, process connection of coaxial tube G 3/4, material 1.4571/316TI, for probe length 200 mm	LFPCT-0200G1	2068141
	Coaxial tube for LFP with process connection G 3/4, process connection of coaxial tube G 3/4, material 1.4571/316TI, for probe length 300 mm	LFPCT-0300G1	2068142
	Coaxial tube for LFP with process connection G 3/4, process connection of coaxial tube G 3/4, material 1.4571/316TI, for probe length 400 mm	LFPCT-0400G1	2068143
	Coaxial tube for LFP with process connection G 3/4, process connection of coaxial tube G 3/4, material 1.4571/316TI, for probe length 500 mm	LFPCT-0500G1	2068144
	Coaxial tube for LFP with process connection G 3/4, process connection of coaxial tube G 3/4, material 1.4571/316TI, for probe length 600 mm	LFPCT-0600G1	2068145
	Coaxial tube for LFP with process connection G 3/4, process connection of coaxial tube G 3/4, material 1.4571/316TI, for probe length 700 mm	LFPCT-0700G1	2068146

	Brief description	Type	Part no.
	Coaxial tube for LFP with process connection G 3/4, process connection of coax probe G 3/4, material 1.4571/316TI, for probe length 800 mm	LFPCT-0800G1	2068147
	Coaxial probe for LFP with process connection G 3/4, process connection of coaxial tube G 3/4, material 1.4571/316TI, for probe length 900 mm	LFPCT-0900G1	2067507
	Coaxial tube for LFP with process connection G 3/4, process connection of coaxial tube G 3/4, material 1.4571/316TI, for probe length 1000 mm	LFPCT-1000G1	2065702
	Coaxial tube for LFP with process connection G 3/4, process connection of coaxial tube G 3/4, material 1.4571/316TI, for probe length 1100 mm	LFPCT-1100G1	2068148
	Coaxial tube for LFP with process connection G 3/4, process connection of coaxial tube G 3/4, material 1.4571/316TI, for probe length 1200 mm	LFPCT-1200G1	2068149
	Coaxial tube for LFP with process connection G 3/4, process connection of coaxial tube G 3/4, material 1.4571/316TI, for probe length 1300 mm	LFPCT-1300G1	2068150
	Coaxial tube for LFP with process connection G 3/4, process connection of coaxial tube G 3/4, material 1.4571/316TI, for probe length 1400 mm	LFPCT-1400G1	2068151
	Coaxial tube for LFP with process connection G 3/4, process connection of coaxial tube G 3/4, material 1.4571/316TI, for probe length 1500 mm	LFPCT-1500G1	2068152
	Coaxial tube for LFP with process connection G 3/4, process connection of coaxial tube G 3/4, material 1.4571/316TI, for probe length 1600 mm	LFPCT-1600G1	2068153
	Coaxial tube for LFP with process connection G 3/4, process connection of coaxial tube G 3/4, material 1.4571/316TI, for probe length 1700 mm	LFPCT-1700G1	2068154
	Coaxial tube for LFP with process connection G 3/4, process connection of coaxial tube G 3/4, material 1.4571/316TI, for probe length 1800 mm	LFPCT-1800G1	2068155
	Coaxial tube for LFP with process connection G 3/4, process connection of coax probe G 3/4, material 1.4571/316TI, for probe length 1900 mm	LFPCT-1900G1	2068156
	Coaxial tube for LFP with process connection G 3/4, process connection of coaxial tube G 3/4, material 1.4571/316TI, for probe length 2000 mm	LFPCT-2000G1	2065703
Flanges			
	Hygienic process connection adapter, coupling (DIN 11864-1) DN 25 form A with union nut; hygienic in accordance with EHEDG	BEF-HA-641D25-LFP1	2058795
	Hygienic process connection adapter, coupling (DIN 11864-2) DN 25 form A; hygienic in accordance with EHEDG	BEF-HA-642D25-LFP1	2058823
	Hygienic process connection adapter, clamp coupling (DIN 11864-3) BKS DN 25 form A, hygienic in accordance with EHEDG	BEF-HA-643D25-LFP1	2058821
	Hygienic process connection adapter, conical coupling (DIN 11851), DN 25 with grooved cap nut; hygienic in accordance with EHEDG in combination with ASEPTO-STAR k-flex upgrade gaskets from Kieselmann GmbH or SKS gasket set DIN 11851 EHEDG with EPDM or FKM inner gasket from Siersema Komponenten Service (S.K.S.) B.V	BEF-HA-851D25-LFP1	2058138
	Hygienic process connection adapter, conical coupling (DIN 11851), DN 40 with grooved cap nut, material 1.4404 (Ra ≤ 0.8 µm); hygienic in accordance with EHEDG in combination with ASEPTO-STAR k-flex upgrade gaskets from Kieselmann GmbH or SKS gasket set DIN 11851 EHEDG with EPDM or FKM inner gasket from Siersema Komponenten Service (S.K.S.) B.V	BEF-HA-851D40-LFP1	2058139
	Hygienic process connection adapter, conical coupling (DIN 11851), DN 50 with grooved cap nut; hygienic in accordance with EHEDG in combination with ASEPTO-STAR k-flex upgrade gaskets from Kieselmann GmbH or SKS gasket set DIN 11851 EHEDG with EPDM or FKM inner gasket from Siersema Komponenten Service (S.K.S.) B.V	BEF-HA-851D50-LFP1	2058141
	Hygienic process connection adapter, conical coupling (DIN 11851), DN 65 with grooved cap nut; hygienic in accordance with EHEDG in combination with ASEPTO-STAR k-flex upgrade gaskets from Kieselmann GmbH or SKS gasket set DIN 11851 EHEDG with EPDM or FKM inner gasket from Siersema Komponenten Service (S.K.S.) B.V	BEF-HA-851D65-LFP1	2063328

	Brief description	Type	Part no.
	Hygienic process connection adapter, Tri-Clamp 1" and 1 1/2"; hygienic in accordance with EHEDG in combination with T-seals or Tri-Clamp seals from Combifit International B.V.	BEF-HA-TCLI10-LFP1	2058808
	Hygienic process connection adapter, Tri-Clamp 1" and 1 1/2", including acceptance test certificate 3.1; Ra ≤ 0.4 µm, hygienic in accordance with EHEDG in combination with T-seals or Tri-Clamp seals from Combifit International B.V.	BEF-HA-TCLI10-LFP2	2126242
	Hygienic process connection adapter, Tri-Clamp 1" and 1 1/2" with leakage indication port according to 3-A guidelines	BEF-HA-TCLI10-LFP3	2058851
	Hygienic process connection adapter, Tri-Clamp 2"; hygienic in accordance with EHEDG in combination with T-seals or Tri-Clamp seals from Combifit International B.V.	BEF-HA-TCLI20-LFP1	2058824
	Hygienic process connection adapter, Tri-Clamp 2"; including acceptance test certificate 3.1; Ra ≤ 0.4 µm, hygienic in accordance with EHEDG in combination with T-seals or Tri-Clamp seals from Combifit International B.V.	BEF-HA-TCLI20-LFP2	2126243
	Hygienic process connection adapter, Tri-Clamp 2 1/2"; hygienic in accordance with EHEDG in combination with T-seals or Tri-Clamp seals from Combifit International B.V.	BEF-HA-TCLI25-LFP1	2069518
	Hygienic process connection adapter, Varivent connection form N; hygienic in accordance with EHEDG in combination with EPDM O-ring	BEF-HA-VAR-TYN-LFP1	2058822
	Weld-in flange, hygienic, G 3/4" including acceptance test certificate 3.1, Ra ≤ 0.4 µm, Stainless steel 1.4404	BEF-HA-SWFL54-LFP2	2122489
Plug connectors and cables			
	<ul style="list-style-type: none"> • Connection type head A: Female connector, M12, 5-pin, straight • Connection type head B: Flying leads • Signal type: Sensor/actuator cable • Cable: 2 m, 5-wire, PVC • Description: Sensor/actuator cable, unshielded • Connection systems: Flying leads • Note: This product is generally resistant to chemical cleaning agents (see ECOLAB). Please do not use cleaning agents of any other Kind., Not resistant against lactic acid & hydrogen peroxide (H2O2) • Application: Hygienic and washdown zones 	DOL-1205-G02MNI	6052625
	<ul style="list-style-type: none"> • Connection type head A: Female connector, M12, 5-pin, straight • Connection type head B: Flying leads • Signal type: Sensor/actuator cable • Cable: 2 m, 5-wire, PP • Description: Sensor/actuator cable, unshielded • Connection systems: Flying leads • Note: This product is generally resistant to chemical cleaning agents (see ECOLAB) and other chemical compounds such as H2O2 and CH2O2. Before permanent installation is carried out, the material's resistance to the cleaning agent being used must be checked., Resistant against lactic acid & hydrogen peroxide (H2O2) • Application: Hygienic and washdown zones, Drag chain operation 	DOL-1205-G02MRN	6058494
	<ul style="list-style-type: none"> • Connection type head A: Female connector, M12, 5-pin, straight • Connection type head B: Flying leads • Signal type: Sensor/actuator cable • Cable: 5 m, 5-wire, PVC • Description: Sensor/actuator cable, unshielded • Connection systems: Flying leads • Note: This product is generally resistant to chemical cleaning agents (see ECOLAB). Please do not use cleaning agents of any other Kind., Not resistant against lactic acid & hydrogen peroxide (H2O2) • Application: Hygienic and washdown zones 	DOL-1205-G05MNI	6052626

	Brief description	Type	Part no.
	<ul style="list-style-type: none"> • Connection type head A: Female connector, M12, 5-pin, straight • Connection type head B: Flying leads • Signal type: Sensor/actuator cable • Cable: 5 m, 5-wire, PP • Description: Sensor/actuator cable, unshielded • Connection systems: Flying leads • Note: This product is generally resistant to chemical cleaning agents (see ECOLAB) and other chemical compounds such as H2O2 and CH2O2. Before permanent installation is carried out, the material's resistance to the cleaning agent being used must be checked., Resistant against lactic acid & hydrogen peroxide (H2O2) • Application: Hygienic and washdown zones, Drag chain operation 	DOL-1205-G05MRN	6058495
	<ul style="list-style-type: none"> • Connection type head A: Female connector, M12, 5-pin, straight • Connection type head B: Flying leads • Signal type: Sensor/actuator cable • Cable: 10 m, 5-wire, PVC • Description: Sensor/actuator cable, unshielded • Connection systems: Flying leads • Note: This product is generally resistant to chemical cleaning agents (see ECOLAB). Please do not use cleaning agents of any other Kind., Not resistant against lactic acid & hydrogen peroxide (H2O2) • Application: Hygienic and washdown zones 	DOL-1205-G10MNI	6052627
	<ul style="list-style-type: none"> • Connection type head A: Female connector, M12, 5-pin, straight • Connection type head B: Flying leads • Signal type: Sensor/actuator cable • Cable: 10 m, 5-wire, PP • Description: Sensor/actuator cable, unshielded • Connection systems: Flying leads • Note: This product is generally resistant to chemical cleaning agents (see ECOLAB) and other chemical compounds such as H2O2 and CH2O2. Before permanent installation is carried out, the material's resistance to the cleaning agent being used must be checked., Resistant against lactic acid & hydrogen peroxide (H2O2) • Application: Hygienic and washdown zones, Drag chain operation 	DOL-1205-G10MRN	6058496
	<ul style="list-style-type: none"> • Connection type head A: Female connector, M12, 5-pin, straight • Connection type head B: Flying leads • Signal type: Sensor/actuator cable • Cable: 25 m, 5-wire, PVC • Description: Sensor/actuator cable, unshielded • Connection systems: Flying leads • Note: This product is generally resistant to chemical cleaning agents (see ECOLAB). Please do not use cleaning agents of any other Kind., Not resistant against lactic acid & hydrogen peroxide (H2O2) • Application: Hygienic and washdown zones 	DOL-1205-G25MNI	6052628
	<ul style="list-style-type: none"> • Connection type head A: Female connector, M12, 5-pin, straight • Connection type head B: Flying leads • Signal type: Sensor/actuator cable • Cable: 25 m, 5-wire, PP • Description: Sensor/actuator cable, unshielded • Connection systems: Flying leads • Note: This product is generally resistant to chemical cleaning agents (see ECOLAB) and other chemical compounds such as H2O2 and CH2O2. Before permanent installation is carried out, the material's resistance to the cleaning agent being used must be checked., Resistant against lactic acid & hydrogen peroxide (H2O2) • Application: Hygienic and washdown zones, Drag chain operation 	DOL-1205-G25MRN	6058497
Terminal and alignment brackets			
	1 piece, Centering for bypass- and immersion tube installation with diameter 40 mm ... 100 mm, PTFE	BEF-FL-BYRD40-LFP1	2059612

Recommended services

Additional services → www.sick.com/LFP_Inox

	Type	Part no.
Function Block Factory		
<ul style="list-style-type: none">• Description: The Function Block Factory supports common programmable logic controllers (PLCs) from various manufacturers, such as Siemens, Beckhoff, Rockwell Automation and B&R. More information on the FBF can be found <a _blank"="" href="https://fbf.cloud.sick.com target=">here.• Note: You can configure your function block at <a _blank"="" href="https://fbf.cloud.sick.com target=">Function Block Factory. As a login please use your SICK ID.	Function Block Factory	On request

SICK AT A GLANCE

SICK is one of the leading manufacturers of intelligent sensors and sensor solutions for industrial applications. A unique range of products and services creates the perfect basis for controlling processes securely and efficiently, protecting individuals from accidents and preventing damage to the environment.

We have extensive experience in a wide range of industries and understand their processes and requirements. With intelligent sensors, we can deliver exactly what our customers need. In application centers in Europe, Asia and North America, system solutions are tested and optimized in accordance with customer specifications. All this makes us a reliable supplier and development partner.

Comprehensive services complete our offering: SICK LifeTime Services provide support throughout the machine life cycle and ensure safety and productivity.

For us, that is “Sensor Intelligence.”

WORLDWIDE PRESENCE:

Contacts and other locations –www.sick.com