



Product designation				Power contactor
Product type designation				BF95
Contact characteristics				
Number of poles	Nr.			4
Rated insulation voltage U_i IEC/EN	V			1000
Rated impulse withstand voltage U_{imp}	kV			8
Operational frequency	min	Hz	25	
	max	Hz	400	
IEC Conventional free air thermal current I_{th}	A			140
Operational current I_e	AC-1 ($\leq 40^\circ\text{C}$)	A	140	
	AC-1 ($\leq 55^\circ\text{C}$)	A	115	
	AC-1 ($\leq 70^\circ\text{C}$)	A	100	
	AC-3 ($\leq 440\text{V} \leq 55^\circ\text{C}$)	A	95	
	AC-4 (400V)	A	45	
Rated operational current AC-3 ($T \leq 55^\circ\text{C}$)	230V	A	95	
	400V	A	95	
	415V	A	95	
	440V	A	95	
	500V	A	95	
	690V	A	93	
	1000V	A	33	
IEC max current I_e in DC1 with $L/R \leq 1\text{ms}$ with 1 poles in series	$\leq 24\text{V}$	A	140	
	48V	A	140	
	75V	A	100	
	110V	A	10	
	220V	A	-	
	IEC max current I_e in DC1 with $L/R \leq 1\text{ms}$ with 2 poles in series	$\leq 24\text{V}$	A	140
48V		A	140	
75V		A	140	
110V		A	110	
220V		A	12	
IEC max current I_e in DC1 with $L/R \leq 1\text{ms}$ with 3 poles in series	$\leq 24\text{V}$	A	140	
	48V	A	140	
	75V	A	155	
	110V	A	120	
	220V	A	125	
IEC max current I_e in DC1 with $L/R \leq 1\text{ms}$ with 4 poles in series	$\leq 24\text{V}$	A	140	
	48V	A	140	

	75V	A	155
	110V	A	140
	220V	A	140
<hr/>			
IEC max current Ie in DC3-DC5 with L/R ≤ 15ms with 1 poles in series			
	≤24V	A	140
	48V	A	44
	75V	A	36
	110V	A	6
	220V	A	–
<hr/>			
IEC max current Ie in DC3-DC5 with L/R ≤ 15ms with 2 poles in series			
	≤24V	A	140
	48V	A	63
	75V	A	60
	110V	A	55
	220V	A	7
<hr/>			
IEC max current Ie in DC3-DC5 with L/R ≤ 15ms with 3 poles in series			
	≤24V	A	140
	48V	A	115
	75V	A	90
	110V	A	85
	220V	A	76
<hr/>			
IEC max current Ie in DC3-DC5 with L/R ≤ 15ms with 4 poles in series			
	≤24V	A	140
	48V	A	110
	75V	A	110
	110V	A	105
	220V	A	95
<hr/>			
Short-time allowable current for 10s (IEC/EN60947-1)		A	760
<hr/>			
Protection fuse			
	gG (IEC)	A	160
	aM (IEC)	A	100
<hr/>			
Making capacity (RMS value)		A	1200
<hr/>			
Breaking capacity at voltage			
	440V	A	1100
	500V	A	775
	690V	A	745
<hr/>			
Resistance per pole (average value)		mΩ	0.45
<hr/>			
Power dissipation per pole (average value)			
	Ith	W	8.8
	AC-3	W	4.1
<hr/>			
Tightening torque for terminals			
	min	Nm	6
	max	Nm	7
	min	lbin	4.4
	max	lbin	5.2
<hr/>			
Tightening torque for coil terminal			
	min	Nm	0.8
	max	Nm	1
	min	lbin	0.59
	max	lbin	0.74
<hr/>			
Conductor section			
	AWG/Kcmil		
	max		2/0

Flexible w/o lug conductor section			
	min	mm ²	1.5
	max	mm ²	70
Flexible c/w lug conductor section			
	min	mm ²	1.5
	max	mm ²	70
Power terminal protection according to IEC/EN 60529			IP20 front
Mechanical features			
Operating position			
	normal allowable	Vertical plan ±30°	
Fixing			Screw / DIN rail 35mm
Weight			g 2420
Conductor section			
AWG/kcmil conductor section			
	max	2/0	
Auxiliary contact characteristics			
Thermal current I _{th}			A 140
Operations			
Mechanical life			cycles 15000000
Electrical life			cycles 1400000
AC coil operating			
Rated AC voltage at 60Hz			V 48
AC operating voltage			
of 50/60Hz coil powered at 50Hz drop-out			
	max	%Us	55
of 60Hz coil powered at 60Hz pick-up			
	min	%Us	80
	max	%Us	110
drop-out			
	min	%Us	20
	max	%Us	55
AC average coil consumption at 20°C			
of 60Hz coil powered at 60Hz			
	in-rush holding	VA	300
		VA	20
Dissipation at holding ≤20°C 50Hz			W 6.5
Max cycles frequency			
Mechanical operation			cycles/h 1500
Operating times			
Average time for U _s control in AC			
Closing NO			
	min	ms	16
	max	ms	32
Opening NO			
	min	ms	9
	max	ms	24

UL technical data

General USE

Contactor

	AC current	A	150
Short-circuit protection fuse, 600V High fault	Short circuit current	kA	100
	Fuse rating	A	200
	Fuse class		J
Standard fault	Short circuit current	kA	10
	Fuse rating	A	250
	Fuse class		RK5

Ambient conditions

Temperature	Operating temperature		
	min	°C	-50
	max	°C	70

Storage temperature	min	°C	-60
	max	°C	+80

Max altitude	m	3000
--------------	---	------

Dimensions

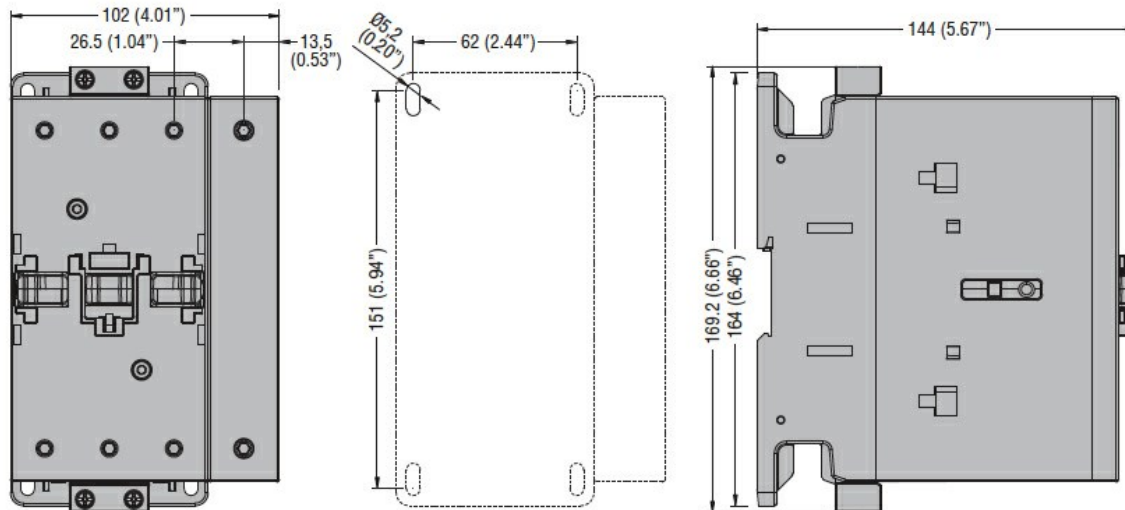

Wiring diagrams

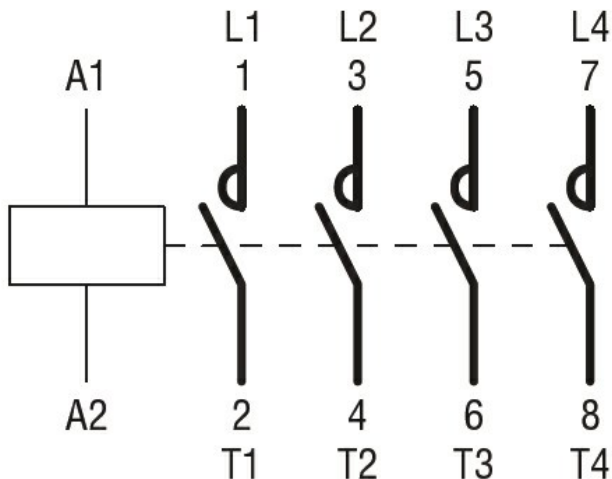

Certifications and compliance

Compliance

CSA C22.2 n° 60947-1

CSA C22.2 n° 60947-4-1

IEC/EN/BS 60947-1

IEC/EN/BS 60947-4-1

UL 60947-1

UL 60947-4-1

Certificates

CCC

cULus

EAC

ETIM classification

ETIM 8.0

EC000066 -
Power contactor,
AC switching