



Product designation	Selector switch actuator key - 2 position
Product type designation	LPCS32

General characteristics

Colour	Black
Type of positions	Selector switch
Material	Polyamide
IEC degree of protection	IP66, IP67 and IP69K

Mechanical features

Mechanical life	cycles	1000000
Mounting adapter		LPXAU120
Weight	g	60

UL technical data

UL degree of protection	Type1, 2, 3R, 4, 4X, 12, 12K
-------------------------	------------------------------

Ambient conditions

Temperature				
	Operating temperature	min	°C	-25
		max	°C	+70
	Storage temperature	min	°C	-40
		max	°C	+85

Dimensions

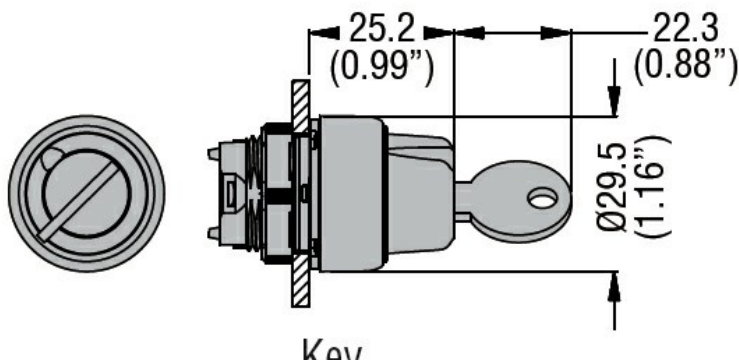

Certifications and compliance

Compliance	CSA C22.2 n° 14
	IEC/EN/BS 60947-1
	IEC/EN/BS 60947-5-1
	UL508
Certificates	CCC
	cULus

ETIM classification

ETIM 8.0

EC000222 -
Front element for
selector switch