



STL-1208-G05MAC1

Sensor/actuator cable

PLUG CONNECTORS AND CABLES

SICK
Sensor Intelligence.



Illustration may differ

Ordering information

Type	Part no.
STL-1208-G05MAC1	6032453

For 8-pin sensor-actuator cables, the wire colors are not standardized. Therefore, please observe the pin assignment of the sensor and the cable in the respective data sheet.

Other models and accessories → www.sick.com/Sensor_actuator_cable

Detailed technical data

Technical specifications

Connection type head A	Male connector, M12, 8-pin, straight
Connection type head B	Flying leads
Connector material	TPU
Connector color	Black
Locking nut material	Brass, nickel-plated
Cable	5 m, PUR, halogen-free
Jacket material	PUR, halogen-free
Jacket color	Black
Cable diameter	7 mm
Conductor cross section	4 x 2 x 0.25 mm ²
Shielding	Shielded
Bending radius	
Flexible use	> 10 x cable diameter
Stationary position	> 5 x cable diameter
Reference voltage	≤ 30 V
Current loading	≤ 4 A
Traversing speed	3 m/s
Signal type	HIPERFACE [®] , SSI, Incremental
Special feature	Twisted pair
Application	Drag chain operation
Enclosure rating	IP67
Operating temperature	
Flexible use	-25 °C ... +80 °C
Head	-25 °C ... +80 °C

Classifications

ECLASS 5.0	19030312
ECLASS 5.1.4	19030312
ECLASS 6.0	27060304
ECLASS 6.2	27060304

ECLASS 7.0	27060304
ECLASS 8.0	27060304
ECLASS 8.1	27060304
ECLASS 9.0	27060304
ECLASS 10.0	27060304
ECLASS 11.0	27060304
ECLASS 12.0	27060304
ETIM 5.0	EC000830
ETIM 6.0	EC000830
ETIM 7.0	EC003249
ETIM 8.0	EC003249
UNSPSC 16.0901	26121604

Dimensional drawing (Dimensions in mm (inch))

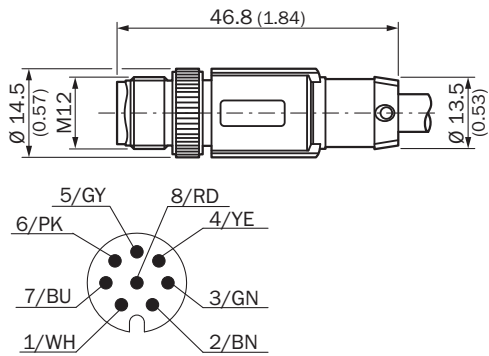

SICK AT A GLANCE

SICK is one of the leading manufacturers of intelligent sensors and sensor solutions for industrial applications. A unique range of products and services creates the perfect basis for controlling processes securely and efficiently, protecting individuals from accidents and preventing damage to the environment.

We have extensive experience in a wide range of industries and understand their processes and requirements. With intelligent sensors, we can deliver exactly what our customers need. In application centers in Europe, Asia and North America, system solutions are tested and optimized in accordance with customer specifications. All this makes us a reliable supplier and development partner.

Comprehensive services complete our offering: SICK LifeTime Services provide support throughout the machine life cycle and ensure safety and productivity.

For us, that is “Sensor Intelligence.”

WORLDWIDE PRESENCE:

Contacts and other locations –www.sick.com