



# V3T11S-MR12A7

TriSpector1000

3D MACHINE VISION

**SICK**  
Sensor Intelligence.



### Ordering information

Type	Part no.
V3T11S-MR12A7	1075604

Other models and accessories → [www.sick.com/TriSpector1000](http://www.sick.com/TriSpector1000)



### Detailed technical data

#### Features

<b>Task</b>	Position determination Presence inspection Quality check Measuring, 3D
<b>Technology</b>	3D triangulation
<b>Product category</b>	Configurable
<b>Toolkit</b>	Shape Area detection Blob Finder Volume Find plane Fixed plane
<b>Working distance</b>	56 mm ... 116 mm
<b>Example field of view</b>	65 mm x 15 mm
<b>Illumination</b>	Integrated
<b>Illumination color</b>	Red, laser, Visible, 660 nm, ± 7 nm
<b>Laser class</b>	2 (EN 60825-1:2014+A11:2021; IEC 60825-1:2014, Complies with the FDA performance requirements for laser products except for conformance with IEC 60825-1 Ed.3., as described in Laser Notice 56 dated May 8, 2019.)
<b>Factory calibrated</b>	✓
<b>Width at minimum operating distance</b>	40 mm
<b>Width at maximum operating distance</b>	75 mm
<b>Maximum height range</b>	60 mm
<b>Imaging angle</b>	65°
<b>Offline support</b>	Emulator

#### Mechanics/electronics

<b>Connection type</b>	M12, 12-pin male connector, A-coded (voltage supply, I/O) M12, 8-pin female connector, X-coded (Gigabit Ethernet) M12, 8-pin female connector, A-coded (encoder)
<b>Connector material</b>	Nickel plated brass
<b>Supply voltage</b>	24 V DC, ± 20 %
<b>Ripple</b>	< 5 V <sub>pp</sub>
<b>Power consumption</b>	≤ 11 W
<b>Current consumption</b>	< 400 mA, without output load

<b>Enclosure rating</b>	IP67
<b>Protection class</b>	III
<b>Housing material</b>	Anodized aluminum
<b>Window material</b>	Glass
<b>Weight</b>	0.9 kg
<b>Dimensions (L x W x H)</b>	136 mm x 62 mm x 84 mm

## Performance

<b>Scan/frame rate</b>	5,000 3D profiles/s
<b>Maximum number of profiles</b>	2,500 Per image
<b>Data points/profile</b>	1,536
<b>Height resolution</b>	20 µm ... 50 µm
<b>3D profile resolution</b>	0.049 mm/px

## Interfaces

<b>Ethernet</b>	✓, TCP/IP
Data transmission rate	1,000 Mbit/s
<b>Serial</b>	✓, RS-232, RS-422
Function	Encoder (RS-422 / DBS36E-BBCP02048)
Data transmission rate	Maximum encoder frequency: 300 MHz
<b>Incremental</b>	✓, TTL
<b>Configuration software</b>	SOPAS ET
<b>Digital input</b>	3 (non-isolated)
<b>Digital output</b>	4 (non-isolated)
<b>Encoder interface</b>	RS-422 / TTL (DBS36E-BBCP02048)
<b>Maximum encoder frequency</b>	300 kHz

## Ambient data

<b>Electromagnetic compatibility (EMC)</b>	EN 61000-6-2:2005 / EN 61000-6-3:2007
<b>Shock load</b>	15 g / 6 ms (EN 60068-2-27)
<b>Vibration load</b>	5 g, 10 Hz ... 150 Hz (EN 60068-2-6)
<b>Ambient operating temperature</b>	0 °C ... +45 °C <sup>1)</sup>
<b>Storage temperature</b>	-20 °C ... +70 °C <sup>1)</sup>

<sup>1)</sup> Permissible relative air humidity: 0 % ... 90 % (non-condensing).

## Classifications

<b>ECLASS 5.0</b>	27310205
<b>ECLASS 5.1.4</b>	27310205
<b>ECLASS 6.0</b>	27310205
<b>ECLASS 6.2</b>	27310205
<b>ECLASS 7.0</b>	27310205
<b>ECLASS 8.0</b>	27310205
<b>ECLASS 8.1</b>	27310205
<b>ECLASS 9.0</b>	27310205

<b>ECLASS 10.0</b>	27310205
<b>ECLASS 11.0</b>	27310205
<b>ECLASS 12.0</b>	27310205
<b>ETIM 5.0</b>	EC001820
<b>ETIM 6.0</b>	EC001820
<b>ETIM 7.0</b>	EC001820
<b>ETIM 8.0</b>	EC001820
<b>UNSPSC 16.0901</b>	43211731

### Dimensional drawing (Dimensions in mm (inch))

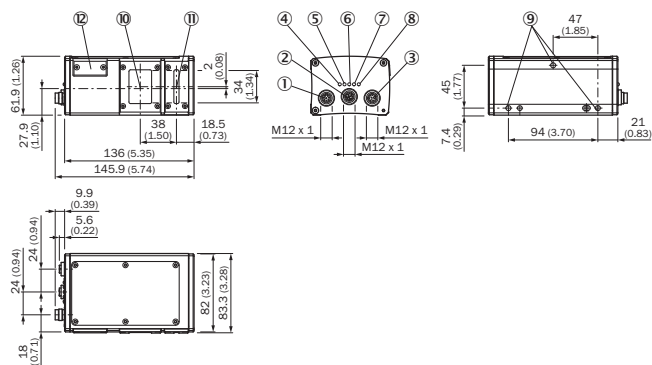

- ① Connector Encoder (thread inside)
- ② Connector Gigabit Ethernet (Gig E)
- ③ Connector Power I/O (thread inside)
- ④ LED; On
- ⑤ LED; State
- ⑥ LED; Link/Data
- ⑦ LED; Result
- ⑧ LED; Laser
- ⑨ Fastening threads (M5 x 8.5 mm length)
- ⑩ Optical receiver (center)
- ⑪ Optical sender (center)
- ⑫ Micro SD memory card

### Field of view

#### Typical field of view

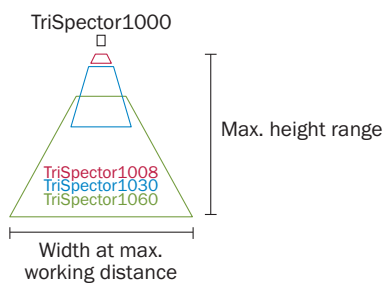





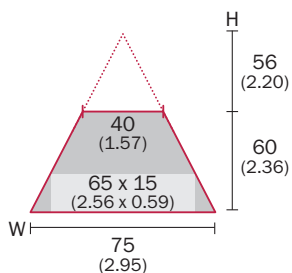

**TriSpector1008**

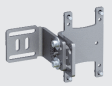

Typ. field of view in mm (inch)



Recommended accessories

Other models and accessories → [www.sick.com/TriSpector1000](http://www.sick.com/TriSpector1000)

	Brief description	Type	Part no.
Mounting brackets and plates			
	Mounting bracket set consisting of mounting bracket, cooling plate, includes angle display for setting the tilt angle	Mounting bracket	2076735
Plug connectors and cables			
	<ul style="list-style-type: none"> <li><b>Connection type head A:</b> Male connector, M12, 5-pin, straight</li> <li><b>Connection type head B:</b> Flying leads</li> <li><b>Cable:</b> 2 m</li> <li><b>Description:</b> Shielded</li> <li><b>Connection systems:</b> Flying leads</li> </ul>	Connecting cable	6024860
	<ul style="list-style-type: none"> <li><b>Connection type head A:</b> Male connector, M12, 8-pin, straight, A-coded</li> <li><b>Connection type head B:</b> Flying leads</li> <li><b>Signal type:</b> Sensor/actuator cable</li> <li><b>Cable:</b> 5 m, 8-wire, PVC</li> <li><b>Description:</b> Sensor/actuator cable, shielded</li> <li><b>Application:</b> Zones with chemicals</li> </ul>	YM2A28-050VA6XLEAX	2096233
	<ul style="list-style-type: none"> <li><b>Connection type head A:</b> Female connector, M12, 8-pin, straight, A-coded</li> <li><b>Connection type head B:</b> Male connector, M12, 8-pin, straight, A-coded</li> <li><b>Signal type:</b> Sensor/actuator cable</li> <li><b>Cable:</b> 2 m, 8-wire, PUR, halogen-free</li> <li><b>Description:</b> Sensor/actuator cable, shielded</li> <li><b>Application:</b> Zones with oils and lubricants, Drag chain operation</li> </ul>	YF2A28-020UA6M2A28	2096105
	<ul style="list-style-type: none"> <li><b>Connection type head A:</b> Female connector, M12, 12-pin, straight</li> <li><b>Connection type head B:</b> Male connector, M12, 5-pin, straight</li> <li><b>Signal type:</b> Power</li> <li><b>Cable:</b> 0.25 m</li> <li><b>Description:</b> Power, Cable for connecting a TriSpector to power supply unit 2079609</li> </ul>	YF2A6B-C25XXM2A15	2079766
	<ul style="list-style-type: none"> <li><b>Connection type head A:</b> Female connector, M12, 12-pin, straight</li> <li><b>Connection type head B:</b> Male connector, M12, 17-pin, straight</li> <li><b>Signal type:</b> Power, digital I/Os, serial</li> <li><b>Cable:</b> 0.25 m</li> <li><b>Description:</b> Power, digital I/Os, serial, shielded, cable to connect TriSpector to CDF600-2, needs to be used in combination with further connection cable (e.g. part number 2055419)</li> </ul>	YF2AAB-C25S01M2AAD	2086398

	Brief description	Type	Part no.
	<ul style="list-style-type: none"> <li>• <b>Connection type head A:</b> Male connector, M12, 8-pin, straight, X-coded</li> <li>• <b>Connection type head B:</b> Male connector, RJ45, 8-pin, straight</li> <li>• <b>Signal type:</b> Ethernet, Gigabit Ethernet</li> <li>• <b>Cable:</b> 2 m, 8-wire, PUR, halogen-free</li> <li>• <b>Description:</b> Ethernet, Gigabit Ethernet, shielded</li> <li>• <b>Application:</b> Zones with oils and lubricants</li> </ul>	YM2X18-020EG1MRJA8	2106258
Others			
	24 V DC power supply unit, 5-pin, M12, for TriSpector in combination with connecting cable 2079766	Power supply unit	2079609

### Recommended services

Additional services → [www.sick.com/TriSpector1000](http://www.sick.com/TriSpector1000)

	Type	Part no.
Commissioning		
<ul style="list-style-type: none"> <li>• <b>Product area:</b> 3D machine vision</li> <li>• <b>Range of services:</b> Inspection of connection, fine adjustment, optimization of parameters of SICK product as well as tests, set-up of previously defined functions of image settings, task configuration, result settings, interface settings, as well as verification tests</li> <li>• <b>Travel expenses:</b> The prices do not include travel costs such as hotel, flight, travel time and expenses.</li> <li>• <b>Duration:</b> Additional work will be invoiced separately</li> </ul>	TriSpector1000 commissioning	1612239
Maintenance		
<ul style="list-style-type: none"> <li>• <b>Product area:</b> 3D machine vision</li> <li>• <b>Range of services:</b> Inspection, analysis and restoring of defined functions, inspection and adaptation of previously defined functions of image settings, task configuration, result settings, and interface settings</li> <li>• <b>Duration:</b> Additional work will be invoiced separately</li> <li>• <b>Travel expenses:</b> The prices do not include travel costs such as hotel, flight, travel time and expenses.</li> </ul>	TriSpector1000 maintenance	1612243
Extended warranty		
<ul style="list-style-type: none"> <li>• <b>Product area:</b> Identification solutions, machine vision, Detection and ranging solutions, safety camera sensors, Safety laser scanners, Safety radar sensors</li> <li>• <b>Range of services:</b> The services correspond to the scope of the statutory manufacturer warranty (SICK general terms of delivery).</li> <li>• <b>Duration:</b> Five-year warranty from delivery date.</li> </ul>	Extended warranty for a total of five years from delivery date	1680671

## SICK AT A GLANCE

SICK is one of the leading manufacturers of intelligent sensors and sensor solutions for industrial applications. A unique range of products and services creates the perfect basis for controlling processes securely and efficiently, protecting individuals from accidents and preventing damage to the environment.

We have extensive experience in a wide range of industries and understand their processes and requirements. With intelligent sensors, we can deliver exactly what our customers need. In application centers in Europe, Asia and North America, system solutions are tested and optimized in accordance with customer specifications. All this makes us a reliable supplier and development partner.

Comprehensive services complete our offering: SICK LifeTime Services provide support throughout the machine life cycle and ensure safety and productivity.

For us, that is “Sensor Intelligence.”

## WORLDWIDE PRESENCE:

Contacts and other locations –[www.sick.com](http://www.sick.com)