



# WL12G-3K2572

## W12G

SMALL PHOTOELECTRIC SENSORS

**SICK**  
Sensor Intelligence.



Illustration may differ



## Ordering information

Type	Part no.
WL12G-3K2572	1053542

**Included in delivery:** BEF-KH-W12 (2)

Other models and accessories → [www.sick.com/W12G](http://www.sick.com/W12G)

## Detailed technical data

### Features

<b>Functional principle</b>	Photoelectric retro-reflective sensor
<b>Functional principle detail</b>	Autocollimation
<b>Sensing range max.</b>	0 m ... 4 m <sup>1)</sup>
<b>Polarisation filters</b>	Yes
<b>Emitted beam</b>	
Light source	PinPoint LED <sup>2)</sup>
Type of light	Visible red light
Light spot size (distance)	Ø 25 mm (1.5 m)
<b>Key LED figures</b>	
Wave length	660 nm
<b>Adjustment</b>	Single teach-in button <sup>3)</sup>
<b>Special applications</b>	Detecting transparent objects
<b>Items supplied</b>	2 x clamps BEF-KH-W12, incl. screws
<b>AutoAdapt</b>	✓

<sup>1)</sup> Reflector PL80A.

<sup>2)</sup> Average service life: 100,000 h at T<sub>U</sub> = +25 °C.

<sup>3)</sup> Mode I, 10 % attenuation.

### Safety-related parameters

<b>MTTF<sub>D</sub></b>	1,099 years
-------------------------	-------------

<b>DC<sub>avg</sub></b>	0 %
-------------------------	-----

### Electrical data

<b>Supply voltage U<sub>B</sub></b>	10 V DC ... 30 V DC <sup>1)</sup>
<b>Ripple</b>	< 5 V <sub>pp</sub> <sup>2)</sup>
<b>Current consumption</b>	40 mA <sup>3)</sup>
<b>Protection class</b>	III
<b>Digital output</b>	
Type	PNP
Switching mode	Light/dark switching
Signal voltage PNP HIGH/LOW	Approx. V <sub>S</sub> - 2.5 V / 0 V
Output current I <sub>max</sub>	≤ 100 mA
Response time	≤ 333 μs <sup>4)</sup>
Switching frequency	1,500 Hz <sup>5)</sup>
<b>Circuit protection</b>	A <sup>6)</sup> B <sup>7)</sup> C <sup>8)</sup> D <sup>9)</sup>
<b>Special feature</b>	Detecting transparent objects
<b>Operating mode</b>	Mode I, 10 % attenuation, Mode II, 18 % attenuation

<sup>1)</sup> Limit values when operated in short-circuit protected network: max. 8 A.

<sup>2)</sup> May not exceed or fall below U<sub>v</sub> tolerances.

<sup>3)</sup> Without load.

<sup>4)</sup> Signal transit time with resistive load.

<sup>5)</sup> With light/dark ratio 1:1.

<sup>6)</sup> A = V<sub>S</sub> connections reverse-polarity protected.

<sup>7)</sup> B = inputs and output reverse-polarity protected.

<sup>8)</sup> C = interference suppression.

<sup>9)</sup> D = outputs overcurrent and short-circuit protected.

### Mechanical data

<b>Housing</b>	Rectangular
<b>Dimensions (W x H x D)</b>	15.5 mm x 48.5 mm x 42 mm
<b>Connection</b>	Male connector M12, 5-pin
<b>Material</b>	
Housing	Metal, zinc diecast
Front screen	Plastic, PMMA
<b>Weight</b>	120 g

### Ambient data

<b>Enclosure rating</b>	IP66 IP67
<b>Ambient operating temperature</b>	-40 °C ... +60 °C
<b>Ambient temperature, storage</b>	-40 °C ... +75 °C
<b>UL File No.</b>	NRKH.E181493 & NRKH7.E181493

### Classifications

<b>ECLASS 5.0</b>	27270902
<b>ECLASS 5.1.4</b>	27270902
<b>ECLASS 6.0</b>	27270902
<b>ECLASS 6.2</b>	27270902
<b>ECLASS 7.0</b>	27270902
<b>ECLASS 8.0</b>	27270902
<b>ECLASS 8.1</b>	27270902
<b>ECLASS 9.0</b>	27270902
<b>ECLASS 10.0</b>	27270902
<b>ECLASS 11.0</b>	27270902
<b>ECLASS 12.0</b>	27270902
<b>ETIM 5.0</b>	EC002717
<b>ETIM 6.0</b>	EC002717
<b>ETIM 7.0</b>	EC002717
<b>ETIM 8.0</b>	EC002717
<b>UNSPSC 16.0901</b>	39121528

### Adjustments

Teach-in

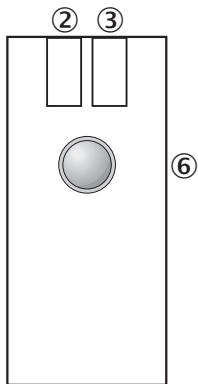

- ② LED indicator yellow: Status of received light beam
- ③ Green LED indicator: power on, teach-in mode I | Blue LED indicator: teach-in mode II
- ⑥ Single teach-in button, Function 1: teach-in sensitivity on reflector, Function 2: change operation/teach-in mode

### Connection diagram

Cd-148

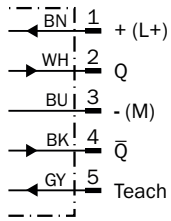

### Light spot size

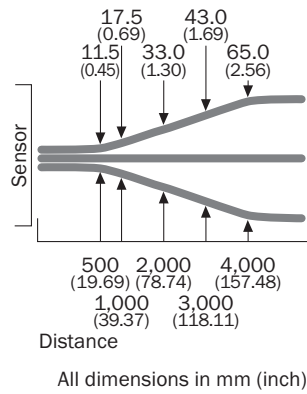

### Sensing range diagram

WL12G-3

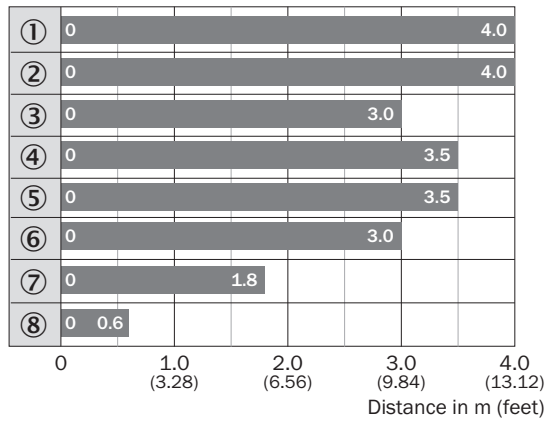

■ Sensing range max.

- ① Reflector PL80A
- ② Reflector C110A
- ③ Reflector P250F
- ④ Reflector PL50A
- ⑤ Reflector PL40A
- ⑥ Reflector PL30A
- ⑦ Reflector PL20A
- ⑧ Reflective tape REF-IRF-56

### Functions

Teach-in-Modus für Objekte / Teach-in mode for objects	Lichtdämpfung / Light attenuation	Objekttyp / Object type	Teach-in-Zeit / Teach-in time	Ext. Teach-in über Leitung / Ext. cable teach-in	Anzeige-LED / LED indicator
I	10 %	PET-Flasche / Folie / Glas / PET-Bottle / Foil / glass	1 ... 5 s	30 ... 100 ms	grün / green
II	18 %	Farbglasflaschen / Colored glass bottles	5 ... 10 s	100 ... 200 ms	blau / blue

### Dimensional drawing (Dimensions in mm (inch))

WL12-3, WSE12-3

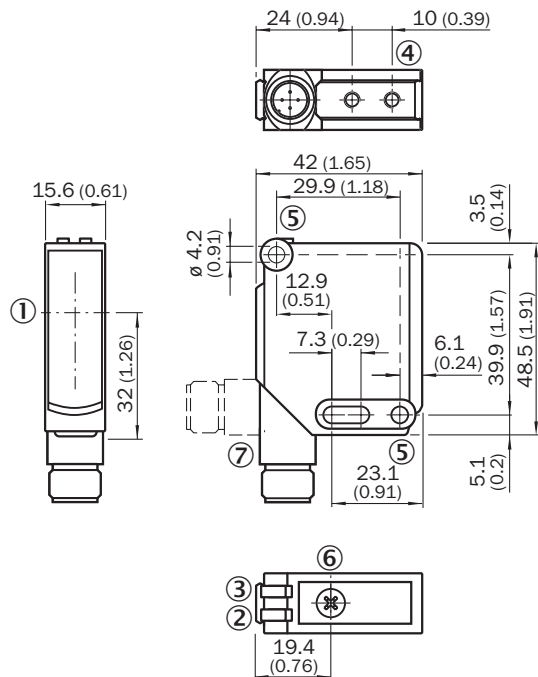

- ① Optical axis
- ② LED indicator yellow: Status of received light beam
- ③ LED indicator green: Supply voltage active
- ④ M4 threaded mounting hole, 4 mm deep
- ⑤ Mounting hole, Ø 4.2 mm
- ⑥ Sensitivity control: potentiometer
- ⑦ Connection

### Recommended accessories

Other models and accessories → [www.sick.com/W12G](http://www.sick.com/W12G)

	Brief description	Type	Part no.
Mounting brackets and plates			
	Universal mounting bracket for reflectors, steel, zinc coated	BEF-WN-REFX	2064574

	<b>Brief description</b>	<b>Type</b>	<b>Part no.</b>
Reflectors			
	Fine triple reflector, screw connection, suitable for laser sensors, 52 mm x 62 mm, PM-MA/ABS, Screw-on, 2 hole mounting	P250F	5308843

## SICK AT A GLANCE

SICK is one of the leading manufacturers of intelligent sensors and sensor solutions for industrial applications. A unique range of products and services creates the perfect basis for controlling processes securely and efficiently, protecting individuals from accidents and preventing damage to the environment.

We have extensive experience in a wide range of industries and understand their processes and requirements. With intelligent sensors, we can deliver exactly what our customers need. In application centers in Europe, Asia and North America, system solutions are tested and optimized in accordance with customer specifications. All this makes us a reliable supplier and development partner.

Comprehensive services complete our offering: SICK LifeTime Services provide support throughout the machine life cycle and ensure safety and productivity.

For us, that is “Sensor Intelligence.”

## WORLDWIDE PRESENCE:

Contacts and other locations –[www.sick.com](http://www.sick.com)