



DFS60B-S1EC00050

DFS60

INCREMENTAL ENCODERS

SICK
Sensor Intelligence.

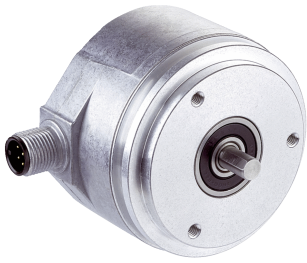

Illustration may differ



Ordering information

Type	Part no.
DFS60B-S1EC00050	1051041

Other models and accessories → www.sick.com/DFS60

Detailed technical data

Performance

Pulses per revolution	50 ¹⁾
Measuring step	90°, electric/pulses per revolution
Measuring step deviation at non binary number of lines	± 0.08°
Error limits	± 0.05°

¹⁾ See maximum revolution range.

Interfaces

Communication interface	Incremental
Communication Interface detail	HTL / Push pull
Number of signal channels	6-channel
Initialization time	40 ms
Output frequency	≤ 600 kHz
Load current	≤ 30 mA
Power consumption	≤ 0.5 W (without load)

Electrical data

Connection type	Male connector, M12, 8-pin, radial
Supply voltage	10 ... 32 V
Reference signal, number	1
Reference signal, position	90°, electric, logically gated with A and B
Reverse polarity protection	✓
Short-circuit protection of the outputs	✓ ¹⁾
MTTFd: mean time to dangerous failure	300 years (EN ISO 13849-1) ²⁾

¹⁾ Short-circuit opposite to another channel, US or GND permissible for maximum 30 s.

²⁾ This product is a standard product and does not constitute a safety component as defined in the Machinery Directive. Calculation based on nominal load of components, average ambient temperature 40°C, frequency of use 8760 h/a. All electronic failures are considered hazardous. For more information, see document no. 8015532.

Mechanical data

Mechanical design	Solid shaft, Servo flange
Shaft diameter	6 mm
Shaft length	10 mm
Weight	+ 0.3 kg
Shaft material	Stainless steel
Flange material	Aluminum
Housing material	Aluminum die cast
Start up torque	0.5 Ncm (+20 °C)
Operating torque	0.3 Ncm (+20 °C)
Permissible shaft loading	80 N (radial) 40 N (axial)
Operating speed	$\leq 9,000 \text{ min}^{-1}$ ¹⁾
Moment of inertia of the rotor	6.2 gcm ²
Bearing lifetime	3.6 x 10 ¹⁰ revolutions
Angular acceleration	$\leq 500,000 \text{ rad/s}^2$

¹⁾ Allow for self-heating of 3.3 K per 1,000 rpm when designing the operating temperature range.

Ambient data

EMC	According to EN 61000-6-2 and EN 61000-6-4
Enclosure rating	IP67, Housing side, male connector (IEC 60529) ¹⁾ IP65, shaft side (IEC 60529)
Permissible relative humidity	90 % (Condensation not permitted)
Operating temperature range	-40 °C ... +100 °C ²⁾ -30 °C ... +100 °C ³⁾
Storage temperature range	-40 °C ... +100 °C, without package
Resistance to shocks	70 g, 6 ms (EN 60068-2-27)
Resistance to vibration	30 g, 10 Hz ... 2,000 Hz (EN 60068-2-6)

¹⁾ With mating connector fitted.

²⁾ Stationary position of the cable.

³⁾ Flexible position of the cable.

Classifications

eCI@ss 5.0	27270501
eCI@ss 5.1.4	27270501
eCI@ss 6.0	27270590
eCI@ss 6.2	27270590
eCI@ss 7.0	27270501
eCI@ss 8.0	27270501
eCI@ss 8.1	27270501
eCI@ss 9.0	27270501
eCI@ss 10.0	27270501
eCI@ss 11.0	27270501
eCI@ss 12.0	27270501

ETIM 5.0	EC001486
ETIM 6.0	EC001486
ETIM 7.0	EC001486
ETIM 8.0	EC001486
UNSPSC 16.0901	41112113

Dimensional drawing (Dimensions in mm (inch))

Servo flange, M12 and M23 radial male connector

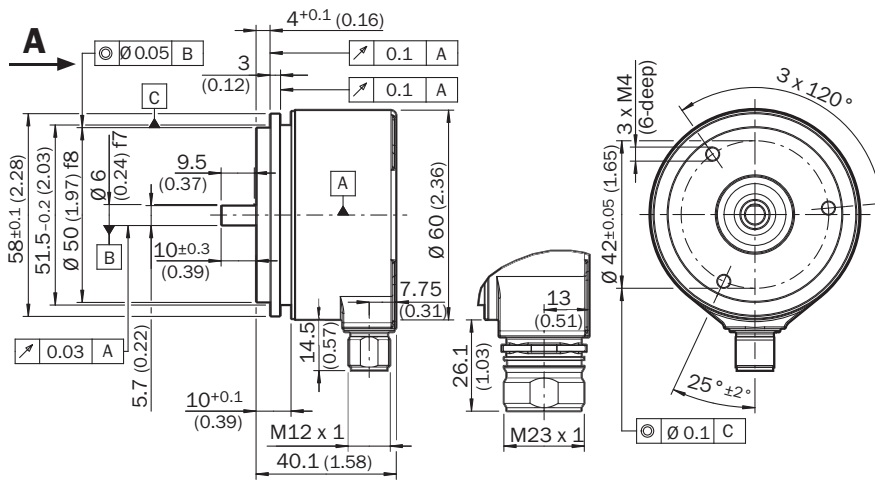

General tolerances according to DIN ISO 2768-mk

Attachment specifications

Mounting requirements for half-shell servo clamp

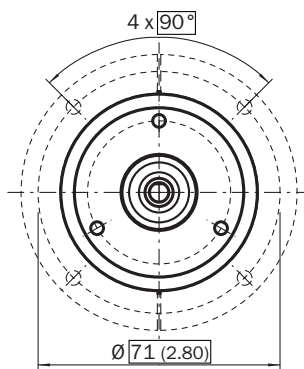

All dimensions in mm (inch)

Part no. 2029165

Mounting requirements for small servo clamp

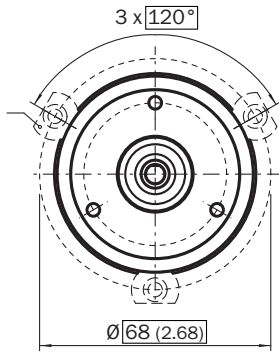

All dimensions in mm (inch)

Part no. 2029166

PIN assignment

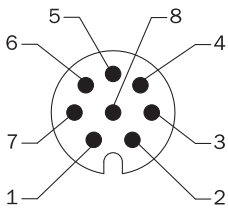

View of M12 male device connector on encoder

PIN Male connector M12, 8-pin	PIN Male connector M23, 12-pin	Wire colors (cable connection)	TTL/HTL signal	Sin/Cos 1.0 V _{pp}	Explanation
1	6	Brown	\bar{A}	COS-	Signal wire
2	5	White	A	COS+	Signal wire
3	1	Black	\bar{B}	SIN-	Signal wire
4	8	Pink	B	SIN+	Signal wire
5	4	Yellow	\bar{Z}	\bar{Z}	Signal wire
6	3	Purple	Z	Z	Signal wire
7	10	Blue	GND	GND	Ground connection
8	12	Red	+U _S	+U _S	Supply voltage
-	9	-	N.c.	N.c.	Not assigned
-	2	-	N.c.	N.c.	Not assigned
-	11	-	N.c.	N.c.	Not assigned
-	7 ¹⁾	Orange	0-SET ¹⁾	N.c.	Set zero pulse ¹⁾
Screen	Screen	Screen	Screen	Screen	Screen connected to housing on encoder side. Connected to ground on control side.

1)

PIN Male connector M12, 8-pin	PIN Male connector M23, 12-pin	Wire colors (cable connection)	TTL/HTL signal	Sin/Cos 1.0 V _{pp}	Explanation
For electrical interfaces only: M, U, V, W with 0-SET function on PIN 7 on M23 plug. The 0-SET input is used to set the zero pulse to the current shaft position. If the 0-SET input is applied to US for longer than 250 ms after it has previously been open or applied to GND for at least 1,000 ms, the current shaft position is assigned zero pulse signal "Z".					

Diagrams

Signal outputs

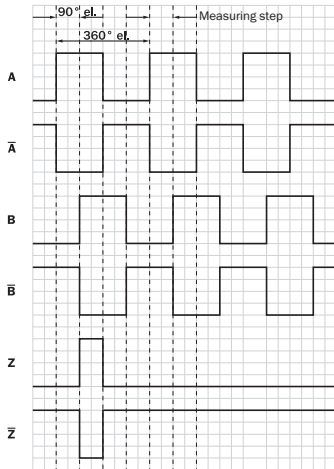



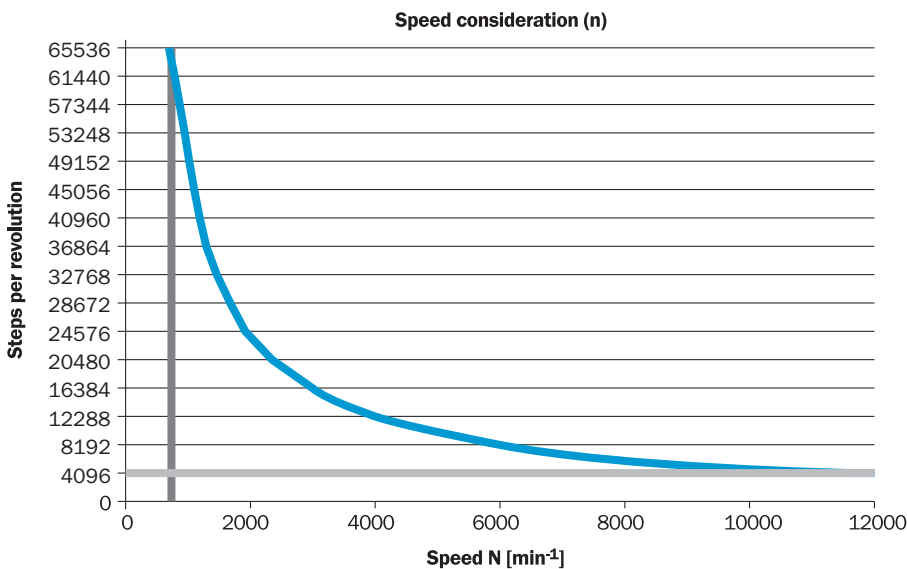



CW with view on the encoder shaft in direction "A", compare dimensional drawing. Maximum revolution range





Supply voltage	Output
4,5 V ... 5,5 V	TTL
10 V ... 32 V	TTL
10 V ... 32 V	HTL

Recommended accessories

Other models and accessories → www.sick.com/DFS60

	Brief description	Type	Part no.
Other mounting accessories			
	Aluminium measuring wheel with O-ring (NBR70) for 6 mm solid shaft, circumference 200 mm	BEF-MR006020R	2055222
	Measuring wheel with O-ring (NBR70) for 6 mm solid shaft, circumference 300 mm	BEF-MR006030R	2055634
	Aluminium measuring wheel with O-ring (NBR70) for 6 mm solid shaft, circumference 500 mm	BEF-MR006050R	2055225
	Aluminum measuring wheel with cross-knurled surface for 6 mm solid shaft, circumference 200 mm	BEF-MR06200AK	4084745
	Aluminum measuring wheel with smooth polyurethane surface for 6 mm solid shaft, circumference 200 mm	BEF-MR06200AP	4084746
	Aluminum measuring wheel with ridged polyurethane surface for 6 mm solid shaft, circumference 200 mm	BEF-MR06200APG	4084748
	Aluminum measuring wheel with studded polyurethane surface for 6 mm solid shaft, circumference 200 mm	BEF-MR06200APN	4084747
	Mounting bell for encoder with servo flange, 50 mm spigot, mounting kit included	BEF-MG-50	5312987
	Bearing block for servo and face mount flange encoder. The heavy-duty bearing block is used to absorb very large radial and axial shaft loads. Particularly when using belt pulleys, chain sprockets, friction wheels. Operating speed max. 4,000 rpm ⁻¹ , axial shaft load 150 N, radial shaft load 250 N, bearing service life 3.6 x 10 ⁹ revolutions	BEF-FA-LB1210	2044591
	Mounting kit for servo flange encoder on the bearing block, 1 bar coupling SKPS 1520 06/06 1 hexagon socket wrench SW1.5 DIN 911, 3 mounting eccentric BEMN 1242 49 3 screws M4 x 10 DIN 912, 1 hexagon socket wrench SW3 DIN 911, 1 bar coupling SKPS 1520 06/06 1 hexagon socket wrench SW1.5 DIN 911, 3 mounting eccentric BEMN 1242 49 3 screws M4 x 10 DIN 912, 1 hexagon socket wrench SW3 DIN 911	BEF-MK-LB	5320872
	Servo clamps, large, for servo flange (clamps, eccentric fastener), 3 pcs, without mounting material, without mounting hardware	BEF-WK-SF	2029166
Plug connectors and cables			
	Head A: female connector, M12, 8-pin, straight Head B: Flying leads Cable: Incremental, SSI, PUR, halogen-free, shielded, 2 m	DOL-1208-G02MAC1	6032866
	Head A: female connector, M12, 8-pin, straight Head B: Flying leads Cable: Incremental, SSI, PUR, halogen-free, shielded, 5 m	DOL-1208-G05MAC1	6032867
	Head A: female connector, M12, 8-pin, straight Head B: Flying leads Cable: Incremental, SSI, PUR, halogen-free, shielded, 10 m	DOL-1208-G10MAC1	6032868
	Head A: female connector, M12, 8-pin, straight Head B: Flying leads Cable: Incremental, SSI, PUR, halogen-free, shielded, 20 m	DOL-1208-G20MAC1	6032869

	Brief description	Type	Part no.
	Head A: female connector, M12, 8-pin, angled Head B: Flying leads Cable: PVC, shielded, 2 m	DOL-1208-W02MA	6020992
	Head A: female connector, M12, 8-pin, angled Head B: Flying leads Cable: HIPERFACE®, Incremental, PUR, halogen-free, shielded, 2 m	DOL-1208-W02MAC1	6037724
	Head A: female connector, M12, 8-pin, angled Head B: Flying leads Cable: Sensor/actuator cable, PUR, halogen-free, shielded, 2 m	DOL-1208-W02MAS01	6029224
	Head A: female connector, M12, 8-pin, angled Head B: Flying leads Cable: PUR, halogen-free, unshielded, 2 m	DOL-1208-W02MC	6035623
	Head A: female connector, M12, 8-pin, angled Head B: Flying leads Cable: PVC, shielded, 5 m	DOL-1208-W05MA	6021033
	Head A: female connector, M12, 8-pin, angled Head B: Flying leads Cable: HIPERFACE®, Incremental, PUR, halogen-free, shielded, 5 m	DOL-1208-W05MAC1	6037725
	Head A: female connector, M12, 8-pin, angled Head B: Flying leads Cable: PUR, unshielded, 5 m	DOL-1208-W05MC	6035624
	Head A: female connector, M12, 8-pin, angled Head B: Flying leads Cable: HIPERFACE®, Incremental, PUR, halogen-free, shielded, 10 m	DOL-1208-W10MAC1	6037726
	Head A: female connector, M12, 8-pin, angled Head B: Flying leads Cable: PUR, halogen-free, unshielded, 10 m	DOL-1208-W10MC	6035625
	Head A: female connector, M12, 8-pin, angled Head B: Flying leads Cable: HIPERFACE®, Incremental, PUR, shielded, 20 m	DOL-1208-W20MAC1	6037727
	Head A: female connector, M12, 8-pin, straight, A-coded Cable: Incremental, SSI, shielded	DOS-1208-GA01	6045001
Shaft adaptation			
	Bellows coupling, shaft diameter 6 mm / 6 mm, maximum shaft offset: radial ± 0.25 mm, axial ± 0.4 mm, angular $\pm 4^\circ$; max. speed 10,000 rpm, -30°C to $+120^\circ\text{C}$, max. torque 120 Ncm; material: stainless steel bellows, aluminum hub	KUP-0606-B	5312981
	Cross-slotted coupling, shaft diameter 6 mm / 6 mm, maximum shaft offset: radial ± 0.3 mm, axial ± 0.2 mm, angle $\pm 3^\circ$; max. speed 10,000 rpm, -10° to $+80^\circ\text{C}$, max. torque 80 Ncm; material: fiber-glass reinforced polyamide, aluminum hub	KUP-0606-S	2056406
	Bar coupling, shaft diameter 6 mm / 8 mm, maximum shaft offset radial ± 0.3 mm, axial ± 0.2 mm, angle $\pm 3^\circ$, max. speed 10,000 rpm, torsion spring rigidity 38 Nm/wheel; material: fiber-glass reinforced polyamide, aluminum hub	KUP-0608-S	5314179
	Bellows coupling, shaft diameter 6 mm / 10 mm, maximum shaft offset: radial ± 0.25 mm, axial ± 0.4 mm, angular $\pm 4^\circ$; max. speed 10,000 rpm, -30°C to $+120^\circ\text{C}$, max. torque 120 Ncm; material: stainless steel bellows, aluminum hub	KUP-0610-B	5312982
	Double loop coupling, shaft diameter 6 mm / 10 mm, max. shaft offset: radially ± 2.5 mm, axially ± 3 mm, angle ± 10 degrees; max. speed 3.000 rpm, -30 to $+80$ degrees Celsius, torsional spring stiffness of 25 Nm/rad	KUP-0610-D	5326697
	Spring washer coupling, shaft diameter 6 mm / 10 mm, Maximum shaft offset: radial ± 0.3 mm, axial ± 0.4 mm, angular $\pm 2.5^\circ$; max. speed 12,000 rpm, -10° to $+80^\circ\text{C}$, max. torque 60 Ncm; material: aluminum flange, glass fiber-reinforced polyamide membrane and hardened steel coupling pin	KUP-0610-F	5312985

	Brief description	Type	Part no.
	Claw coupling, shaft diameter 6 mm / 10 mm, damping element 80 shore blue, maximum shaft offset: radial ± 0.22 mm, axial ± 1 mm angular $\pm 1.3^\circ$, max. speed 19,000 rpm, angle of twist max. 10° , -30°C to $+80^\circ\text{C}$, max. torque 800 Ncm, tightening torque of screws: ISO 4029 150 Ncm, material: aluminum flange, damping element: polyurethane	KUP-0610-J	2127056
	Bar coupling, shaft diameter 6 mm / 10 mm, max. shaft offset: radial $\pm 0,3$ mm, axial $\pm 0,3$ mm, angular $\pm 3^\circ$; max. speed 10.000 rpm, -10° to $+80^\circ\text{C}$, max. torque: 80 Ncm, material: fiber-glass reinforced polyamide, aluminum hub	KUP-0610-S	2056407

SICK AT A GLANCE

SICK is one of the leading manufacturers of intelligent sensors and sensor solutions for industrial applications. A unique range of products and services creates the perfect basis for controlling processes securely and efficiently, protecting individuals from accidents and preventing damage to the environment.

We have extensive experience in a wide range of industries and understand their processes and requirements. With intelligent sensors, we can deliver exactly what our customers need. In application centers in Europe, Asia and North America, system solutions are tested and optimized in accordance with customer specifications. All this makes us a reliable supplier and development partner.

Comprehensive services complete our offering: SICK LifeTime Services provide support throughout the machine life cycle and ensure safety and productivity.

For us, that is “Sensor Intelligence.”

WORLDWIDE PRESENCE:

Contacts and other locations –www.sick.com