

# RE23-SA05

RE2

NON-CONTACT SAFETY SWITCHES

**SICK**  
Sensor Intelligence.



### Ordering information

Type	Part no.
RE23-SA05	1061726

Other models and accessories → [www.sick.com/RE2](http://www.sick.com/RE2)



### Detailed technical data

#### Features

<b>System part</b>	Sensor with actuator
<b>Sensor principle</b>	Magnetic
<b>Number of N/O contacts</b>	2
<b>Number of N/C contacts</b>	0
<b>Number of signaling contacts</b>	0
<b>Safe switch on distance <math>S_{ao}</math></b>	9 mm
<b>Safe switch off distance <math>S_{ar}</math></b>	22 mm
<b>Active sensor surfaces</b>	1
<b>Actuation directions</b>	3

#### Safety-related parameters

<b><math>B_{10d}</math> parameter</b>	$2 \times 10^7$ switching cycles (with small load)
<b>Type</b>	Type 4 (EN ISO 14119)
<b>Actuator coding level</b>	Low coding level (EN ISO 14119)
<b>Safe state in the event of a fault</b>	The switch has no internal fault detection and is unable to assume a safe state in the event of a fault. Fault detection is performed by the connected safety-related logic unit.

#### Functions

<b>Safe series connection</b>	None, only individual wiring (with diagnostics)
-------------------------------	---

#### Interfaces

<b>Connection type</b>	Cable
Length of cable	5 m
Cable diameter	5.8 mm
Conductor cross section	0.25 mm <sup>2</sup>
Bend radius (with fixed installation)	> 12 x cable diameter
Bend radius (with moving cable)	> 15 x cable diameter
Cable material	PVC
Conductor material	Copper
<b>Display elements</b>	LEDs

### Electrical data

<b>Type of output</b>	Reed contacts
<b>Switching voltage</b>	≤ 30 V DC
<b>Switching current</b>	≤ 100 mA

### Mechanical data

<b>Design</b>	Rectangular
<b>Dimensions (W x H x D)</b>	25 mm x 88 mm x 13 mm
<b>Weight</b>	0.3 kg
<b>Housing material</b>	VISTAL®

### Ambient data

<b>Enclosure rating</b>	IP67 (IEC 60529)
<b>Ambient operating temperature</b>	-30 °C ... +60 °C
<b>Storage temperature</b>	-30 °C ... +60 °C
<b>Vibration resistance</b>	10 Hz ... 55 Hz, 1 mm (EN 60947-5-3)
<b>Shock resistance</b>	30 g, 11 ms (EN 60947-5-3)

### Classifications

<b>ECLASS 5.0</b>	27272402
<b>ECLASS 5.1.4</b>	27272402
<b>ECLASS 6.0</b>	27272402
<b>ECLASS 6.2</b>	27272402
<b>ECLASS 7.0</b>	27272402
<b>ECLASS 8.0</b>	27272402
<b>ECLASS 8.1</b>	27272402
<b>ECLASS 9.0</b>	27272402
<b>ECLASS 10.0</b>	27272402
<b>ECLASS 11.0</b>	27272402
<b>ECLASS 12.0</b>	27274401
<b>ETIM 5.0</b>	EC002544
<b>ETIM 6.0</b>	EC002544
<b>ETIM 7.0</b>	EC002544
<b>ETIM 8.0</b>	EC002544
<b>UNSPSC 16.0901</b>	39122205

### Dimensional drawing (Dimensions in mm (inch))

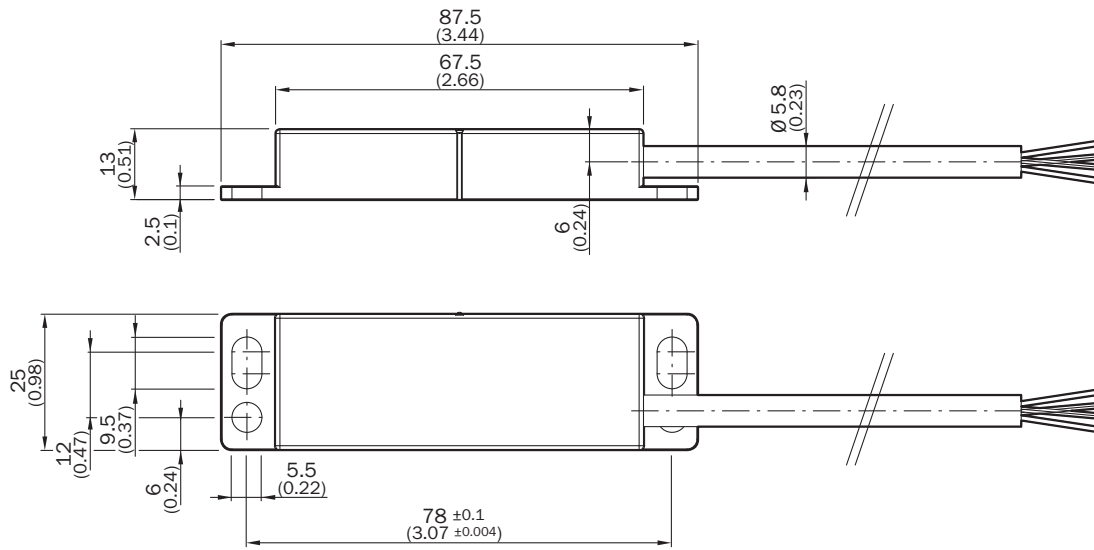

### Response range

RE23

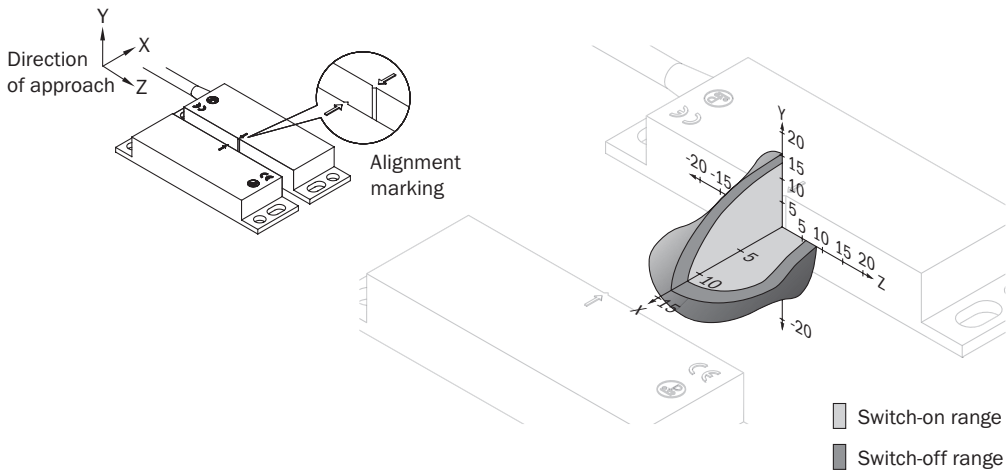

### Pin assignment

REx3: sensor connections (plug M8)

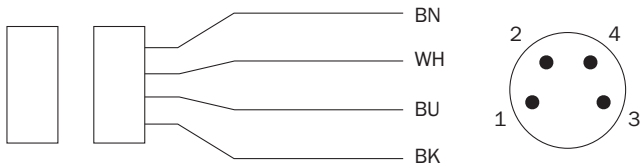

1 BN	N/O contact
2 WH	
3 BU	N/O contact
4 BK	

### Sensor timing

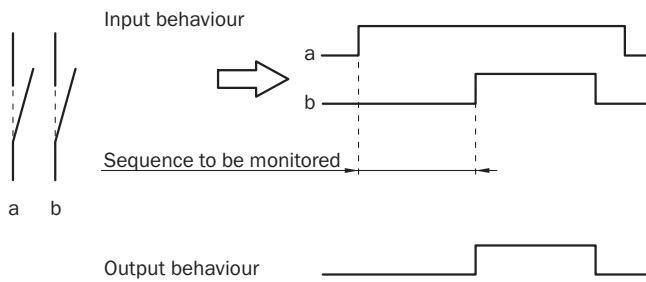

## SICK AT A GLANCE

SICK is one of the leading manufacturers of intelligent sensors and sensor solutions for industrial applications. A unique range of products and services creates the perfect basis for controlling processes securely and efficiently, protecting individuals from accidents and preventing damage to the environment.

We have extensive experience in a wide range of industries and understand their processes and requirements. With intelligent sensors, we can deliver exactly what our customers need. In application centers in Europe, Asia and North America, system solutions are tested and optimized in accordance with customer specifications. All this makes us a reliable supplier and development partner.

Comprehensive services complete our offering: SICK LifeTime Services provide support throughout the machine life cycle and ensure safety and productivity.

For us, that is “Sensor Intelligence.”

## WORLDWIDE PRESENCE:

Contacts and other locations –[www.sick.com](http://www.sick.com)