



MPS-G50CSH55D43ZZZ

MPS-G

POSITION SENSORS

SICK
Sensor Intelligence.



Ordering information

Type	Part no.
MPS-G50CSH55D43ZZZ	1108674

Other models and accessories → www.sick.com/MPS-G



Detailed technical data

Features

Cylinder type	C-slot
Preferred manufacturer slot	SMC, Schunk, PHD, Bimba
Detection zone	0 mm ... 50 mm ¹⁾
Cylinder types with adapter	T-slot cylinders Round body cylinder Profile cylinders and tie-rod cylinders
Measuring range	50 mm
Housing length	25 mm
Output function	Analog
Electrical wiring	DC 4-wire
Analog output (voltage)	0 V ... 10 V
Enclosure rating	IP67
Adjustment	Teach-in button Initialization of dynamic teach for measuring range Resetting of measuring range Manual adjustment of measuring range
Special features	Completely embedded mounting in the slot, providing protection

¹⁾ Deviations are possible depending on the drive.

Mechanics/electronics

Supply voltage	13 V DC ... 30 V DC ¹⁾
Min. load resistance	≥ 2 kΩ
Protection class	III
Time delay before availability	0.15 s
Power consumption	≤ 550 mW

¹⁾ 12 V DC ... 30 V DC for deactivated out-of-range display.

²⁾ The sensor must not be subjected to magnetic fields strengths of > 20 mT!

³⁾ For measuring range > 37 mm, the following applies for the resolution: Measuring range / 3,723.

⁴⁾ At 25 ° C, linearity error (maximum deviation) depending on response curve and minimal deviation function.

⁵⁾ At 25 ° C, repeatability magnet movement in one direction.

⁶⁾ The analog measured value can deviate under transient conditions.

Required magnetic field sensitivity, typ.	2 mT ... 20 mT ²⁾
Resolution, typ.	0,01 mm ³⁾
Linearity error, typ.	0.3 mm ⁴⁾
Repeat accuracy, typ.	0.05 mm ⁵⁾
Sampling rate, typ.	1 ms
Reverse polarity protection	Yes
Short-circuit protection	Yes
Status indicator LED	Yes
Teach-in	Yes
Ambient operating temperature	-20 °C ... +70 °C
Shock and vibration resistance	30 g, 11 ms / 10 ... 55 Hz, 1 mm
EMC	According to EN 60947-5-7 ⁶⁾
Connection type	Cable with connector M8, with knurled nuts, 0.5 m
Connection type Detail	
Conductor cross section	0.08 mm ²
Cable diameter	Ø 2.6 mm
Bending radius	For flexible use > 10 x cable diameter With fixed installation > 5 x cable diameter
Cable outlet	Axial
Control elements connection cable	
Connection type	Cable, 4-wire, 0.5 m
Control elements connection cable detail	
Conductor size	0.09 mm ²
Cable diameter	Ø 2.2 mm
Bending radius	For flexible use > 10 x cable diameter With fixed installation > 5 x cable diameter
Cable outlet	Axial
Material	
Housing	Plastic, PA, strengthened
Cable	PUR
Control element	Plastic, TPU, reinforced

¹⁾ 12 V DC ... 30 V DC for deactivated out-of-range display.

²⁾ The sensor must not be subjected to magnetic fields strengths of > 20 mT!

³⁾ For measuring range > 37 mm, the following applies for the resolution: Measuring range / 3,723.

⁴⁾ At 25 °C, linearity error (maximum deviation) depending on response curve and minimal deviation function.

⁵⁾ At 25 °C, repeatability magnet movement in one direction.

⁶⁾ The analog measured value can deviate under transient conditions.

Safety-related parameters

MTTF_D	358 years
DC_{avg}	0 %
T_M (mission time)	20 years

Classifications

ECLASS 5.0	27270104
-------------------	----------

ECLASS 5.1.4	27270104
ECLASS 6.0	27270104
ECLASS 6.2	27270104
ECLASS 7.0	27270104
ECLASS 8.0	27270104
ECLASS 8.1	27270104
ECLASS 9.0	27270104
ECLASS 10.0	27270104
ECLASS 11.0	27270104
ECLASS 12.0	27274301
ETIM 5.0	EC002544
ETIM 6.0	EC002544
ETIM 7.0	EC002544
ETIM 8.0	EC002544
UNSPSC 16.0901	39122230

Installation note

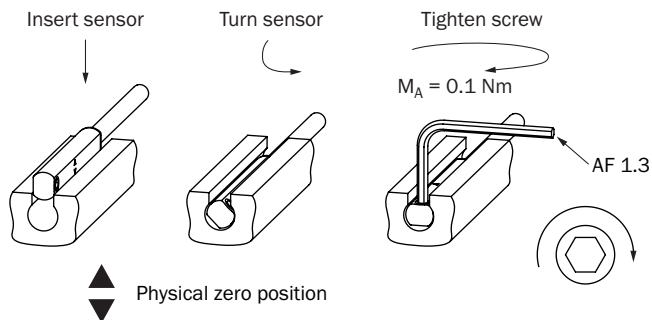

Connection diagram

Cd-465

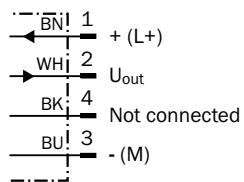

Dimensional drawing (Dimensions in mm (inch))

Cable with connector M8, with knurled nuts

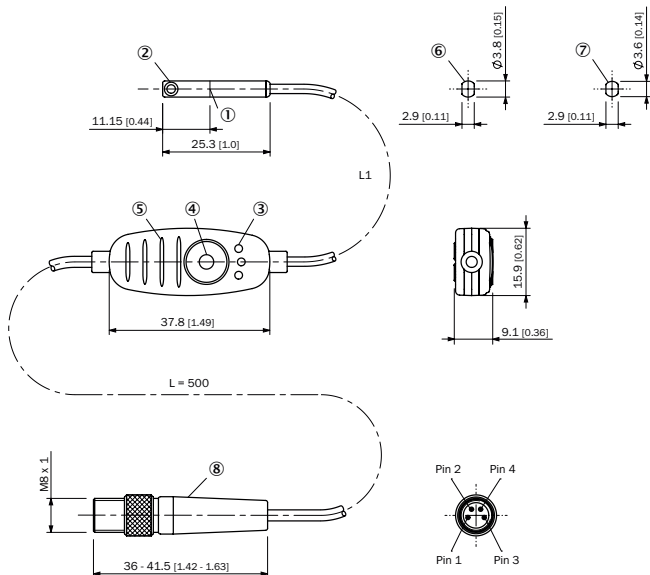





- ① Center of sensor element
- ② Fixing screw SW 1.3
- ③ Display LED
- ④ Teach-in button
- ⑤ Ribbing for cable ties
- ⑥ For SMC, Schunk, PHD, Bimba slot (MPS-G50CS...)
- ⑦ For Festo, Zimmer, Gimatic slot (MPS-G50CF...)
- ⑧ Connection

Part no.	Type	L1	Number of cores
1108672	MPS-G50CFH15D43ZZZ	100 mm	4
1108673	MPS-G50CSH15D43ZZZ	100 mm	4
1108674	MPS-G50CSH55D43ZZZ	500 mm	4
1127842	MPS-G50CFH15D31DZZ	100 mm	4
1127843	MPS-G50CSH15D31DZZ	100 mm	4
1127844	MPS-G50CSH55D31DZZ	500 mm	4
1127848	MPS-G50CFH15D31DZZ	100 mm	4
1127849	MPS-G50CSH15D31DZZ	100 mm	4

Recommended accessories

Other models and accessories → www.sick.com/MPS-G

	Brief description	Type	Part no.
Brackets for cylinder sensors			
	Mounting is by means of the enclosed adhesive pad, 2x M3 countersunk screws or 2x cable ties, plastic, including double-sided adhesive pad	BEF-CPMPS-G	2117133

	Brief description	Type	Part no.
	Preferred manufacturer slot Festo, SMC, Pneumax, Airtec, plastic	BEF-KHZ-TC3	2117770
Plug connectors and cables			
	<ul style="list-style-type: none"> • Connection type head A: Female connector, M8, 4-pin, straight, A-coded • Connection type head B: Flying leads • Signal type: Sensor/actuator cable • Cable: 5 m, 4-wire, PVC • Description: Sensor/actuator cable, unshielded • Application: Zones with chemicals 	YF8U14-050VA3XLEAX	2095889
	<ul style="list-style-type: none"> • Connection type head A: Male connector, M8, 4-pin, straight • Description: Unshielded • Connection systems: Screw-type terminals • Permitted cross-section: 0.14 mm² ... 0.5 mm² 	STE-0804-G	6037323

SICK AT A GLANCE

SICK is one of the leading manufacturers of intelligent sensors and sensor solutions for industrial applications. A unique range of products and services creates the perfect basis for controlling processes securely and efficiently, protecting individuals from accidents and preventing damage to the environment.

We have extensive experience in a wide range of industries and understand their processes and requirements. With intelligent sensors, we can deliver exactly what our customers need. In application centers in Europe, Asia and North America, system solutions are tested and optimized in accordance with customer specifications. All this makes us a reliable supplier and development partner.

Comprehensive services complete our offering: SICK LifeTime Services provide support throughout the machine life cycle and ensure safety and productivity.

For us, that is “Sensor Intelligence.”

WORLDWIDE PRESENCE:

Contacts and other locations –www.sick.com