

0.5 Nm 5 and 7.5 Watts 7.5 Watts Part number made to order



Part numbers

Type	Type	Number of phases	Ratios	
82 924 030	7.5 Watts	82 924 0	4	20

Specifications

Stepper motor / Number of phases	82 920 012 / 4
Gearbox	81 021
Step angle (°)	7,5
Maximum permitted torque from gearmotor under continuous conditions (Nm)	0,5
Axial load static (daN)	1
Radial load static (daN)	8
Absorbed power (W)	7,5
Coil temperature (°C)	120
Weight (g)	140
Wires length (mm)	250
Protection rating	IP40

Dimensions (mm)

82 924 0

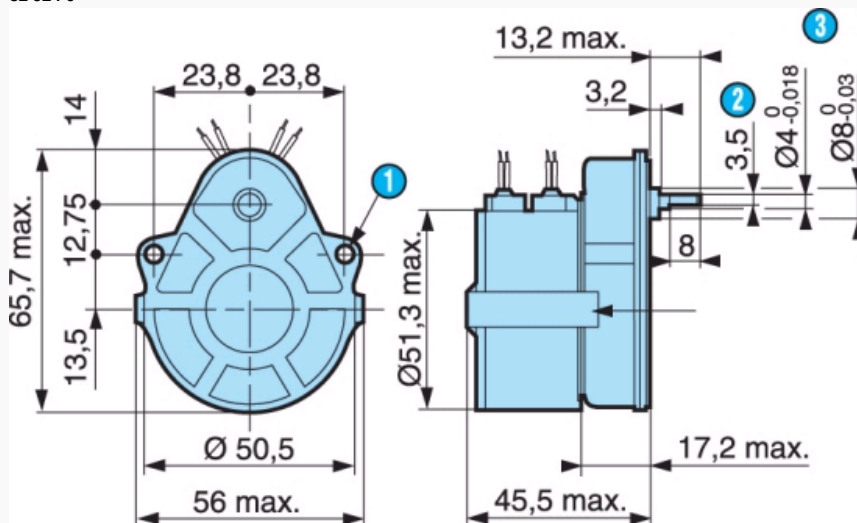

N°	Legend
1	2 fixing holes $\varnothing 3.2$
2	3.5 across flat
3	(pushed-in shaft)

Product adaptations



- Special output shafts
- Special supply voltages
- Special cable lengths
- Special output bearings
- Special connectors
- Special gearbox ratios
- Special mounting plate
- Special gear wheel material