



# TMM88A-PLC090

TMS/TMM88

INCLINATION SENSORS

**SICK**  
Sensor Intelligence.



Illustration may differ

## Ordering information

Type	Part no.
TMM88A-PLC090	1073801

Other models and accessories → [www.sick.com/TMS\\_TMM88](http://www.sick.com/TMS_TMM88)



## Detailed technical data

### Performance

<b>Number of axis</b>	2
<b>Measuring range</b>	± 90°
<b>Resolution</b>	0.01°
<b>Static measurement accuracy</b>	≤ ± 60°, typ. ± 0.02°, max. ± 0.06° ≤ ± 70°, typ. ± 0.04°, max. ± 0.12° ≤ ± 80°, typ. ± 0.08°, max. ± 0.24° ≤ ± 85°, typ. ± 0.16°, max. ± 0.48°
<b>Compensated cross-sensitivity (2-dimensional)</b>	Typ. ± 0.09°, max. ± 0.45°
<b>Temperature coefficient (zero point)</b>	Typ. ± 0.0083°/K <sup>1)</sup>
<b>Limit frequency</b>	0.1 Hz ... 25 Hz, 8. range (with digital filter)
<b>Sampling rate</b>	100 Hz

<sup>1)</sup> Referring to the temperature of 25 °C.

### Interfaces

<b>Communication interface</b>	Analog / Voltage
<b>Voltage output</b>	0 V ... 10 V
<b>Parameterising data</b>	Measuring range Zeraset Limit frequency Preset value Inverting of counting direction Axis assignment Free adjustable outbound
<b>Programmable/configurable</b>	Over PGT-12-Pro
<b>Initialization time</b>	330 ms

### Electrical data

<b>Connection type</b>	Male connector, M12, 5-pin <sup>1)</sup>
<b>Supply voltage</b>	10 V DC ... 35 V DC
<b>Current consumption</b>	55 mA @ 24 V
<b>Reverse polarity protection</b>	✓

<sup>1)</sup> Max. length of connection cable: 3 meter.

<sup>2)</sup> This product is a standard product and does not constitute a safety component as defined in the Machinery Directive. Calculation based on nominal load of components, average ambient temperature 40 °C, frequency of use 8760 h/a. All electronic failures are considered hazardous. For more information, see document no. 8015532.

<b>Short-circuit protection of the outputs</b>	✓
<b>MTTFd: mean time to dangerous failure</b>	287 years (EN ISO 13849-1) <sup>2)</sup>

1) Max. length of connection cable: 3 meter.

2) This product is a standard product and does not constitute a safety component as defined in the Machinery Directive. Calculation based on nominal load of components, average ambient temperature 40 °C, frequency of use 8760 h/a. All electronic failures are considered hazardous. For more information, see document no. 8015532.

### Mechanical data

<b>Dimensions</b>	66 mm x 90 mm x 36 mm
<b>Weight</b>	200 g
<b>Housing material</b>	Plastic (PBT)

### Ambient data

<b>EMC</b>	EN 61326-1, EN ISO 14982, EN ISO 13309
<b>Enclosure rating</b>	IP65 IP67
<b>Operating temperature range</b>	-40 °C ... +80 °C
<b>Storage temperature range</b>	-40 °C ... +85 °C
<b>Resistance to shocks</b>	100 g, 6 ms (according to EN 60068-2-27)
<b>Resistance to vibration</b>	10 g, 10 Hz ... 2,000 Hz (EN 60068-2-6)

### Classifications

<b>eCl@ss 5.0</b>	27270790
<b>eCl@ss 5.1.4</b>	27270790
<b>eCl@ss 6.0</b>	27270790
<b>eCl@ss 6.2</b>	27270790
<b>eCl@ss 7.0</b>	27270790
<b>eCl@ss 8.0</b>	27270790
<b>eCl@ss 8.1</b>	27270790
<b>eCl@ss 9.0</b>	27270790
<b>eCl@ss 10.0</b>	27271101
<b>eCl@ss 11.0</b>	27271101
<b>eCl@ss 12.0</b>	27271101
<b>ETIM 5.0</b>	EC001852
<b>ETIM 6.0</b>	EC001852
<b>ETIM 7.0</b>	EC001852
<b>ETIM 8.0</b>	EC001852
<b>UNSPSC 16.0901</b>	41111613

### Dimensional drawing (Dimensions in mm (inch))

TMx88x-PxC

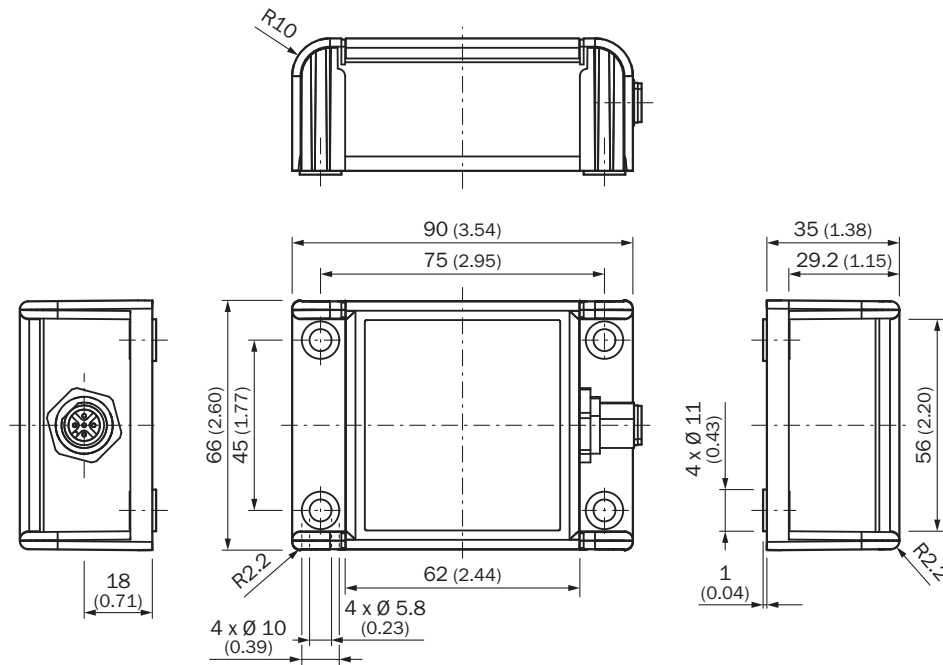



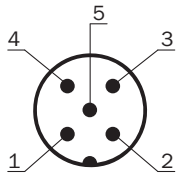



### PIN assignment



PIN Male connector M12, 5-pin	Signal	Function
1	VDC	Supply voltage
2	B-OUT	Sensor output B (default: Y)
3	GND	0V (GND)
4	A-OUT	Sensor output A (default: X)
5	TEACH	Input for Zero point setting

Recommended accessories

Other models and accessories → [www.sick.com/TMS\\_TMM88](http://www.sick.com/TMS_TMM88)

	Brief description	Type	Part no.
<b>Programming and configuration tools</b>			
	Hand-held programming device for the programmable SICK AHS/AHM36 CANopen encoders, TMS/TMM61 CANopen inclination sensors, TMS/TMM88 CANopen, TMS/TMM88 Analog, and wire draw encoders with AHS/AHM36 CANopen. Compact dimensions, low weight, and intuitive operation.	PGT-12-Pro	1076313
<b>Plug connectors and cables</b>			
	Head A: female connector, M12, 5-pin, angled, A-coded Head B: Flying leads Cable: Sensor/actuator cable, Power, PUR, halogen-free, shielded, 1.5 m	DOL-1205-W1M5ACSCO	6049455
	Head A: female connector, M12, 5-pin, straight, A-coded Head B: Flying leads Cable: Sensor/actuator cable, PUR, halogen-free, shielded, 1.5 m	YF2A25-015UB6XLEAX	2095833
	Head A: female connector, M12, 5-pin, straight, A-coded Head B: Flying leads Cable: Sensor/actuator cable, PUR, halogen-free, shielded, 3 m	YF2A25-030UB6XLEAX	2095834
	Head A: female connector, M12, 5-pin, angled, A-coded Head B: Flying leads Cable: Sensor/actuator cable, PUR, halogen-free, shielded, 3 m	YG2A25-030UB6XLEAX	2095791
	Head A: female connector, M12, 5-pin, angled, A-coded Head B: Flying leads Cable: Sensor/actuator cable, PUR, halogen-free, shielded, 5 m	YG2A25-050UB6XLEAX	2095792
	Head A: female connector, M12, 5-pin, angled, A-coded Head B: Flying leads Cable: Sensor/actuator cable, PUR, halogen-free, shielded, 10 m	YG2A25-100UB6XLEAX	2095793
	Head A: female connector, M12, 5-pin, straight Cable: unshielded	DOS-1205-G	6009719
	Head A: male connector, M12, 5-pin, straight Cable: unshielded For field bus technology	STE-1205-G	6022083

## SICK AT A GLANCE

SICK is one of the leading manufacturers of intelligent sensors and sensor solutions for industrial applications. A unique range of products and services creates the perfect basis for controlling processes securely and efficiently, protecting individuals from accidents and preventing damage to the environment.

We have extensive experience in a wide range of industries and understand their processes and requirements. With intelligent sensors, we can deliver exactly what our customers need. In application centers in Europe, Asia and North America, system solutions are tested and optimized in accordance with customer specifications. All this makes us a reliable supplier and development partner.

Comprehensive services complete our offering: SICK LifeTime Services provide support throughout the machine life cycle and ensure safety and productivity.

For us, that is “Sensor Intelligence.”

## WORLDWIDE PRESENCE:

Contacts and other locations –[www.sick.com](http://www.sick.com)