



Power contactor
B6301000

Product designation

Product type designation

Contact characteristics

Number of poles	Nr.	4
Rated insulation voltage U_i IEC/EN	V	1000
Rated impulse withstand voltage U_{imp}	kV	8
Operational frequency	min	Hz 25
	max	Hz 400
IEC Conventional free air thermal current I_{th}	A	1000
Operational current I_e	AC-1 ($\leq 40^\circ\text{C}$)	A 1000
	AC-1 ($\leq 55^\circ\text{C}$)	A 850
	AC-1 ($\leq 70^\circ\text{C}$)	A 700
	AC-4 (400V)	A 260
Rated operational power AC-1 ($T \leq 40^\circ\text{C}$)	230V	kW 350
	400V	kW 600
	500V	kW 750
	690V	kW 1000
IEC max current I_e in DC1 with $L/R \leq 1\text{ms}$ with 1 poles in series	75V	A 800
	110V	A 460
	220V	A --
	330V	A --
	460V	A --
IEC max current I_e in DC1 with $L/R \leq 1\text{ms}$ with 2 poles in series	75V	A 800
	110V	A 800
	220V	A 700
	330V	A --
	460V	A --
IEC max current I_e in DC1 with $L/R \leq 1\text{ms}$ with 3 poles in series	75V	A 800
	110V	A 800
	220V	A 800
	330V	A 700
	460V	A --
IEC max current I_e in DC1 with $L/R \leq 1\text{ms}$ with 4 poles in series	75V	A 800
	110V	A 800
	220V	A 800
	330V	A 750
	460V	A 700
IEC max current I_e in DC3-DC5 with $L/R \leq 15\text{ms}$ with 1 poles in series		

	75V	A	800
	110V	A	460
	220V	A	--
	330V	A	--
	460V	A	--
<hr/>			
IEC max current Ie in DC3-DC5 with L/R ≤ 15ms with 2 poles in series			
	75V	A	800
	110V	A	800
	220V	A	700
	330V	A	--
	460V	A	--
<hr/>			
IEC max current Ie in DC3-DC5 with L/R ≤ 15ms with 3 poles in series			
	75V	A	800
	110V	A	800
	220V	A	800
	330V	A	650
	460V	A	--
<hr/>			
IEC max current Ie in DC3-DC5 with L/R ≤ 15ms with 4 poles in series			
	75V	A	800
	110V	A	800
	220V	A	800
	330V	A	650
	460V	A	700
<hr/>			
Short-time allowable current for 10s (IEC/EN60947-1)		A	5600
<hr/>			
Protection fuse		gG (IEC)	A 1000
<hr/>			
Making capacity (RMS value)		A	6300
<hr/>			
Breaking capacity at voltage		440V	A 6300
		500V	A 5600
		690V	A 5000
<hr/>			
Resistance per pole (average value)		mΩ	0.14
<hr/>			
Power dissipation per pole (average value)		Ith	W 140
		AC-3	W 56
<hr/>			
Tightening torque for terminals		min	Nm 55
		max	Nm 55
		min	Ibin 40.6
		max	Ibin 40.6
<hr/>			
Tightening torque for coil terminal		min	Nm 1
		max	Nm 1
		min	Ibin 0.74
		max	Ibin 0.74
<hr/>			
Max number of wires simultaneously connectable		Nr.	2
<hr/>			
Conductor section		AWG/Kcmil	
		max	2x 900 kcmil
<hr/>			
Power terminal protection according to IEC/EN 60529			IP00
<hr/>			
Mechanical features			
Operating position		normal	Vertical plan

Fixing	allowable		±30°
Weight		g	Screw 26
Conductor section			
	AWG/kcmil conductor section		
		max	2x 900 kcmil
Operations			
Mechanical life		cycles	5000000
Electrical life		cycles	700000
Safety related data			
Performance level B10d according to EN/ISO 13489-1			
		rated load mechanical load	cycles cycles
			700000 5000000
Mirror contacts according to IEC/EN 609474-4-1			yes
EMC compatibility			yes
AC coil operating			
Rated AC voltage at 50/60Hz		V	60
AC operating voltage			
	of 50/60Hz coil powered at 50Hz		
	pick-up	min	%Us 80
		max	%Us 110
	drop-out	min	%Us 20
		max	%Us 60
	of 50/60Hz coil powered at 60Hz		
	pick-up	min	%Us 80
		max	%Us 110
	drop-out	min	%Us 20
		max	%Us 60
	of 60Hz coil powered at 60Hz		
	pick-up	min	%Us 80
		max	%Us 110
	drop-out	min	%Us 20
		max	%Us 60
AC average coil consumption at 20°C			
	of 50/60Hz coil powered at 50Hz		
		in-rush	VA 400
		holding	VA 18
	of 50/60Hz coil powered at 60Hz		
		in-rush	VA 400
		holding	VA 18
Dissipation at holding ≤20°C 50Hz		W	18
DC coil operating			
DC rated control voltage		V	60
DC operating voltage			
	pick-up	min	%Us 80
		max	%Us 110

drop-out	min	%Us	20
	max	%Us	60

Average coil consumption $\leq 20^{\circ}\text{C}$	in-rush	W	400
	holding	W	18

Max cycles frequency

Mechanical operation	cycles/h	1200
----------------------	----------	------

Operating times

Average time for Us control			
in AC			
Closing NO	min	ms	110
	max	ms	180
Opening NO	min	ms	60
	max	ms	100
in DC			
Closing NO	min	ms	110
	max	ms	180
Opening NO	min	ms	60
	max	ms	100

UL technical data

General USE			
Contactor	AC current	A	1000
Short-circuit protection fuse, 600V			
Standard fault	Short circuit current	kA	18
	Fuse rating	A	1500
	Fuse class		L

Ambient conditions

Temperature			
Operating temperature			
	min	$^{\circ}\text{C}$	-50
	max	$^{\circ}\text{C}$	70
Storage temperature			
	min	$^{\circ}\text{C}$	-60
	max	$^{\circ}\text{C}$	80

Max altitude	m	3000
--------------	---	------

Resistance & Protection

Pollution degree	3
------------------	---

Dimensions

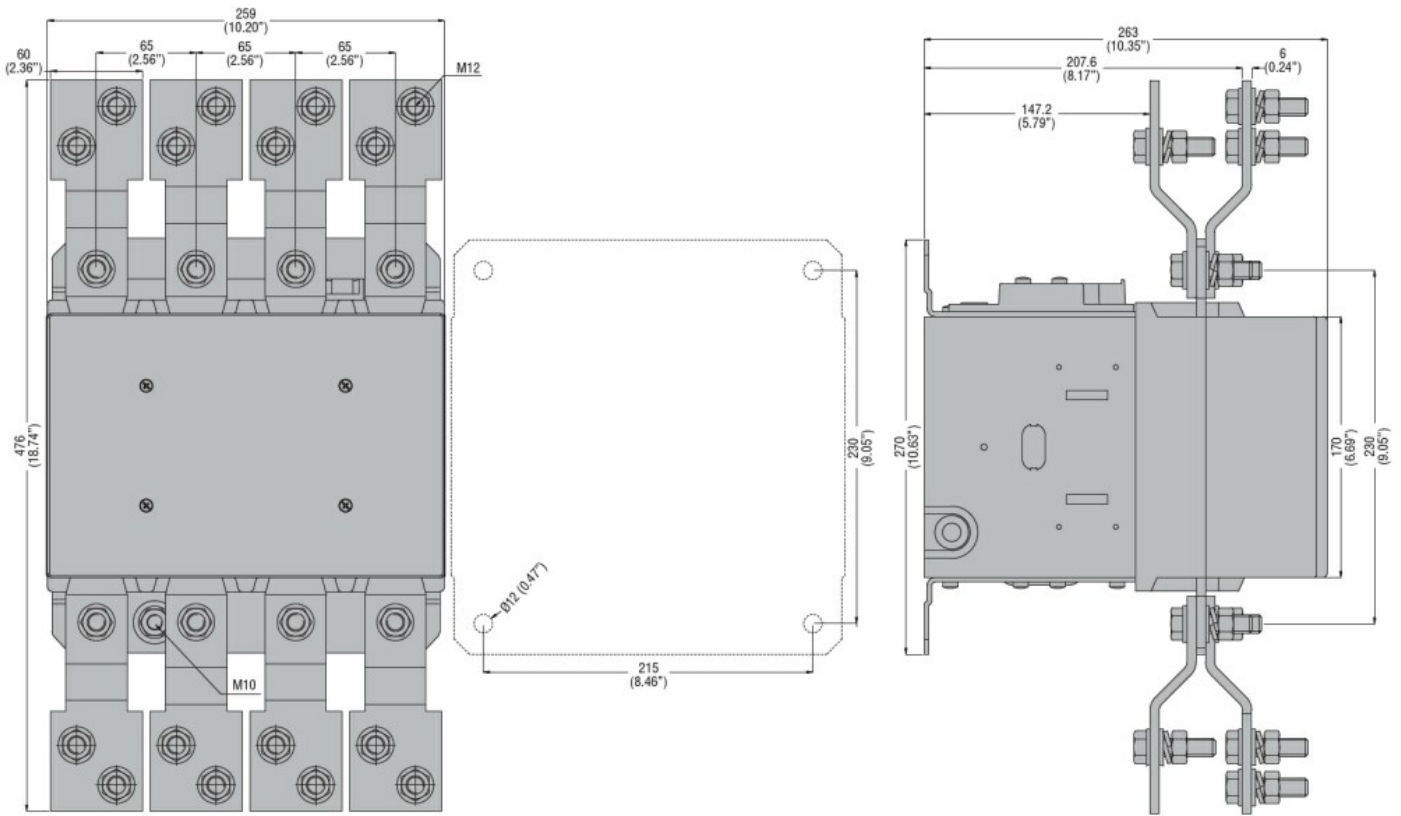

Wiring diagrams

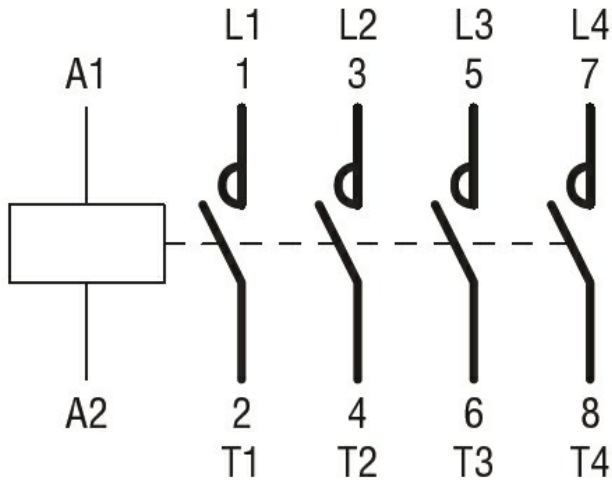

Certifications and compliance

Compliance

- CSA C22.2 n° 60947-1
- CSA C22.2 n° 60947-4-1
- IEC/EN 60947-1
- IEC/EN 60947-4-1
- UL 60947-1
- UL 60947-4-1

Certificates

- CCC
- cULus
- EAC

ETIM classification

ETIM 8.0

EC000066 -
Power contactor,
AC switching