

Part number

TMAP 06 L25



Surface mounting housing, T-TYPE series, with 1 lever, M25 cable entry, size "44.27", high construction

Product description		Material properties	
Product type	Surface mounting housing	Main material	Polypropylene (PP)
Series	T-TYPE	Other materials	Lever: Polyamide (PA) Gasket: polyurethane (PUR)
Closing type	With 1 lever	Colour	RAL 7012 grey, RAL 7001 grey
Size	Size 44.27	RoHs conformity	Compliant
Cable entry	With cable entry M25	China RoHs - EFUP	E
Specification	High construction	REACH SVHC substances	No
Technical data		Approvals / Standards	
IP degree of protection	IP65	UL	ECBT2
Further technical details		cUL	ECBT8
Weight	0,12 g	General ordering information	
Operating temperature range (min, max)	-40°C ... +90°C	EAN13 code	8015747168571
		eCl@ss 8.1	27440202
		ETIM 7.0	EC000437
		Packaging Information	
		Packaging length	180,00 mm
		Packaging height	210,00 mm
		Packaging width	330,00 mm
		Packaging weight	2,99 kg
		Packaging volume	12,47 dm ³
		Packaging description	Carton box
		Packaging quantity	20 Pcs
		Packaging EAN code	8015747170208
		Sub-packaging weight	0,75 kg
		Sub-packaging description	Plastic packaging
		Sub-packaging quantity	5 Pcs
		Sub-packaging EAN barcode	8015747170215

Part number

TMAP 06 L25



Catalogue drawings

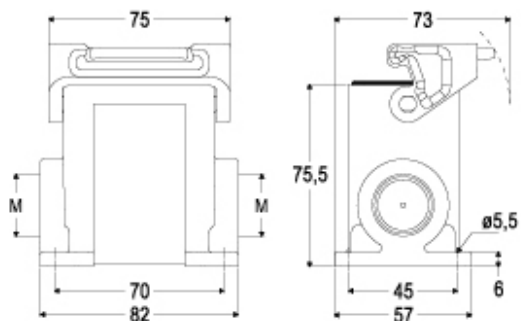

Notes

Dimensions shown in mm are not binding and may be changed without notice.
