

Teile - Nr./ Typ part no./ type	Kodierung coding	Erläuterung der Kodierung/ exposition the coding: Positionierung (P) / positioning Kodierung (K) / coding Verrastung zwischen Kammer (V) / to lock in place
15.410.1457.2 8105FU/ 4C10 VL RW GW	C 10	 P = 2a, 4a K = 01c, d40 V = 3+4
15.411.0457.2 8105FU/ 4C 1 VL RW GW	C 1	 P = 1b K = 03c, d40 V = 1+2, 3+4
15.411.1457.2 8105FU/ 4C11 VL RW GW	C 11	 P = 2a, 4a K = 01c, d30 V = 2+3
15.412.1457.2 8105FU/ 4C12 VL RW GW	C 12	 P = 4a K = 02c V = 3+4
15.413.1457.2 8105FU/ 4C13 VL RW GW	C 13	 P = 1b, 3b K = 02c, d40 V = 2+3
15.417.0457.2 8105FU/ 4C 7 VL RW GW	C 7	 P = 1b, 4b K = 01c V = 1+2, 3+4
15.418.0457.2 8105FU/ 4C 8 VL RW GW	C 8	 P = 1b, 4b K = d40 V = 1+2, 3+4
15.419.0457.2 8105FU/ 4C 9 VL RW GW	C 9	 P = 1b, 3b K = 02c, d40 V = 3+4

Weitere Farben auf Anfrage
further colours on request

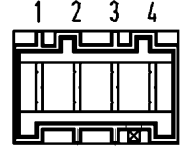

Schnitt A-A
section A-A

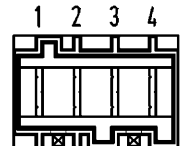
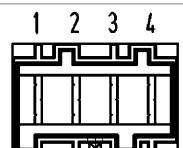
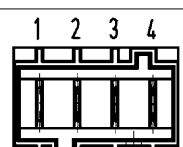
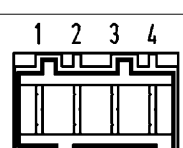
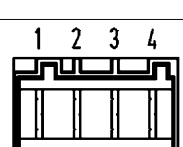
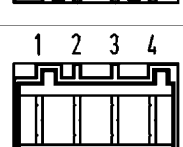
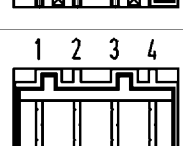
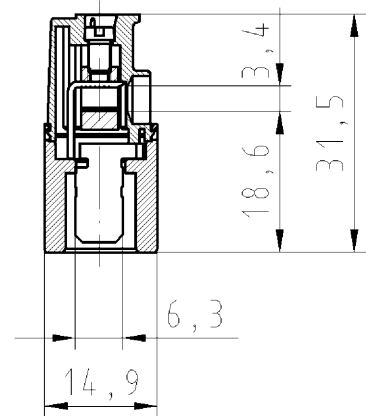

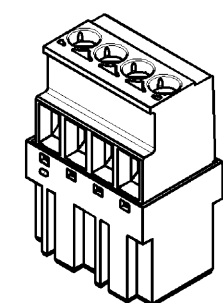
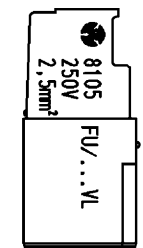
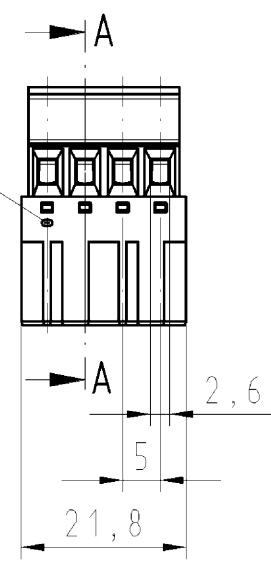
ACHTUNG! Unterscheidungsmerkmal
flammwidriges Material/
ATTENTION! differentiator
for flame resistant material



Weitere Daten siehe Katalog
further data see catalog

Tolerierung nach DIN 7167/Tolerance system acc. to DIN 7167. (This DIN-standard describes the envelope principle. According to the envelope principle the deviations of form and parallelism are limited by the size tolerances).		ja/yes <input checked="" type="checkbox"/> Stoffverbots- und Deklarationsliste nach UU-TQM-05/03 ist einzuhalten. Conformity with Wieland document UU-TQM-05/03 (list of prohibited / declarable hazardous substances) to be declared!	
Freitoleranz nach DIN ISO 2768 mk General tolerance		CAD - Zeichnung, keine manuellen Änderungen CAD - drawing, no manual modifications allowed	1. Verwendung: - First Use:
Blatt: 1 von 1 Sheet: of 1		Zeichnung Nr./Drawing No. Index	
/  Werkstoff/Material		2010 Tag/Date Name	T 15.410.1457.0 01K
/ Maßstab/Scale		gezeichnet/drawn 23.09. Treschan	
/ 1:1		geprüft/checked - -	Maße in mm/Dimensions are in mm
/ Vol. mm³ Ofl./Surf. mm²		Normgepr. Stand. check - -	
/ Ersatz für/Replacement for: -		Benennung/Title	
/  wieland		Type 8105FU/ 4 C... VL RW GW	pluggable PCB terminal LP_STECKVERBINDER
Index Datum / Blatt Date / Sheet		vertikale Ausführung/vertical version, Verriegelung innen/locking inside, 4-polig/4poles, 10A, 2,5qmm	
Änderung/Revision		Elektrische Verbindungen	

Weitergabe sowie Vervielfältigung dieses Dokuments, Verwertung und Mitteilung seines Inhalts sind verboten, soweit nicht ausdrücklich gestattet.
The reproduction, distribution and utilization of this document as well as the communication of its contents to others without express authorization is prohibited.