

Part number

MHP 16.25

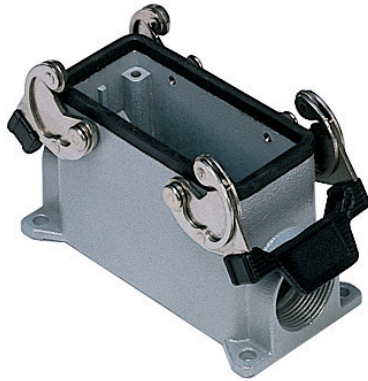

Surface mounting housing, C-TYPE series, with 2 levers, M25 cable entry, size "77.27"



Product description

Product type	Surface mounting housing
Series	C-TYPE
Closing type	With 2 levers
Size	Size "77.27"
Cable entry	M25

Technical data

IP degree of protection	IP66 (and IP69 DIN 40050 - 9)
--------------------------------	-------------------------------

Further technical details

Weight	410,00 g
Operating temperature range (min, max)	-40°C...+125°C

Material properties

Colour	RAL 7040 grey
RoHs conformity	Compliant
China RoHs - EFUP	E
REACH SVHC substances	No

Approvals / Standards

Certifications	DNV-GL, BV
UL	ECBT2
cUL	ECBT8

General ordering information

EAN13 code	8015747054621
eCl@ss 8.1	27440202
ETIM 7.0	EC000437

Packaging Information

Packaging length	475,00 mm
Packaging height	180,00 mm
Packaging width	175,00 mm
Packaging weight	3,85 kg
Packaging volume	14,96 dm ³
Packaging description	Carton box
Packaging quantity	10 Pcs
Packaging EAN code	8015747249393
Sub-packaging weight	1,93 kg
Sub-packaging description	Plastic packaging
Sub-packaging quantity	5 Pcs
Sub-packaging EAN barcode	8015747054645

Part number

MHP 16.25



Catalogue drawings

CHP CAP - MHP MAP

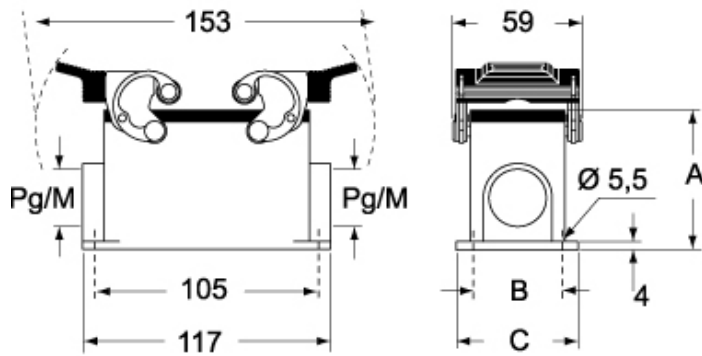

CHP CS/CP CAP CS/CP - MHP CS/CP MAP CS/CP

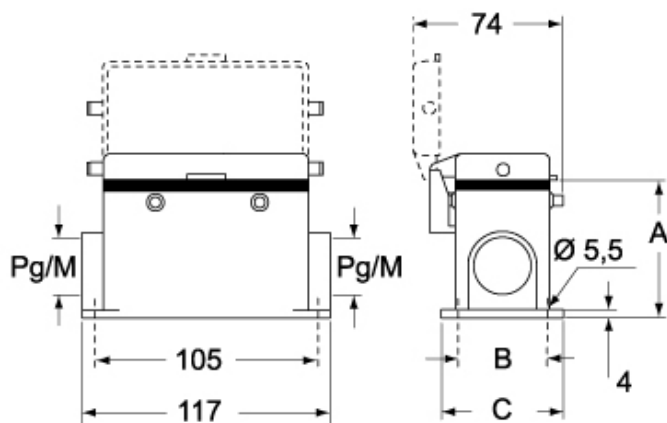

	A
CHP / MHP	63
CAP / MAP	77
CHP CS / MHP CS	63
CAP CS / MAP CS	77
CHP CP / MHP CP	63
CAP CP / MAP CP	77

Notes

Dimensions shown in mm are not binding and may be changed without notice.