



WTF12L-34162820A00

W12

SMALL PHOTOELECTRIC SENSORS

SICK
Sensor Intelligence.



Illustration may differ

Ordering information

| Type | Part no. |
|--------------------|----------|
| WTF12L-34162820A00 | 1126061 |

Other models and accessories → www.sick.com/W12



Detailed technical data

Features

| | |
|---|---|
| Functional principle | Photoelectric proximity sensor |
| Functional principle detail | Foreground suppression |
| Sensing range | |
| Sensing range min. | 20 mm |
| Sensing range max. | 150 mm |
| Adjustable switching threshold for background suppression | 35 mm ... 150 mm |
| Reference object | Object with 90% remission factor (complies with standard white according to DIN 5033) |
| Minimum object height at set sensing range in front of black background (6% remission factor) | 2 mm, at a distance of 90 mm |
| Recommended sensing range for the best performance | 40 mm ... 120 mm |
| Emitted beam | |
| Light source | Laser |
| Type of light | Visible red light |
| Shape of light spot | Ellipse shape |
| Light spot size (distance) | 2.8 mm x 1.25 mm (120 mm) |
| Maximum dispersion of the emitted beam around the standardized transmission axis (squint angle) | < +/- 1.0° (at Ta = +23 °C) |
| Key laser figures | |
| Normative reference | EN 60825-1:2014, IEC 60825-1:2014 |

| | |
|--|---|
| Laser class | 1 |
| Wave length | 655 nm |
| Pulse duration | 4 μ s |
| Maximum pulse power | < 4.03 mW |
| Average service life | 50,000 h at $T_U = +25$ °C |
| Smallest detectable object (MDO) typ. | 2.8 mm (at a distance of 120 mm) Object with 90% remission factor (complies with standard white according to DIN 5033) |
| Adjustment | |
| Teach-Turn adjustment | BluePilot: For setting the sensing range |
| IO-Link | For configuring the sensor parameters and Smart Task functions |
| Indication | |
| LED blue | BluePilot: sensing range indicator |
| LED green | Operating indicator Static on: power on Flashing: IO-Link mode |
| LED yellow | Status of received light beam Static on: object present Static off: object not present |
| Special applications | Detecting small objects, Detection of objects moving at high speeds, Detecting flat objects, Detecting perforated objects |

Safety-related parameters

| | |
|-------------------------------------|--|
| MTTF_D | 280 years |
| DC_{avg} | 0 % |
| T_M (mission time) | 10 years (EN ISO 13849, rate of use: 60 %) |

Communication interface

| | |
|-----------------------------|--|
| IO-Link | ✓, IO-Link V1.1 |
| Data transmission rate | COM2 (38,4 kBaud) |
| Cycle time | 2.3 ms |
| Process data length | 16 Bit |
| Process data structure | Bit 0 = switching signal Q _{L1} Bit 1 = switching signal Q _{L2} Bit 2 ... 15 = Current receiver level (live) |
| VendorID | 26 |
| DeviceID HEX | 0x8002D7 |
| DeviceID DEC | 8389335 |
| Compatible master port type | A |
| SIO mode support | Yes |

Electrical data

| | |
|-------------------------------------|-----------------------------------|
| Supply voltage U_B | 10 V DC ... 30 V DC ¹⁾ |
| Ripple | ≤ 5 V |

¹⁾ Limit values.

²⁾ Signal transit time with resistive load in switching mode.

³⁾ With light/dark ratio 1:1.

⁴⁾ This switching output must not be connected to another output.

| | |
|-------------------------------|---|
| Usage category | DC-12 (According to EN 60947-5-2) DC-13 (According to EN 60947-5-2) |
| Current consumption | ≤ 14 mA, without load. At $U_B = 24\text{ V}$ |
| Protection class | III |
| Digital output | |
| Number | 2 (Complementary) |
| Type | Push-pull: PNP/NPN |
| Signal voltage PNP HIGH/LOW | Approx. $U_B - 2.5\text{ V} / 0\text{ V}$ |
| Signal voltage NPN HIGH/LOW | Approx. $U_B / < 2.5\text{ V}$ |
| Output current $I_{\max.}$ | ≤ 100 mA |
| Circuit protection outputs | Reverse polarity protected Overcurrent protected Short-circuit protected |
| Response time | ≤ 200 μs ²⁾ |
| Repeatability (response time) | 85 μs ²⁾ |
| Switching frequency | 2,500 Hz ³⁾ |
| Pin/Wire assignment | |
| BN 1 | + (L+) |
| WH 2 | \bar{Q}_{L1}/MF Digital output, dark switching, object present → output \bar{Q}_{L1} HIGH ⁴⁾ The pin 2 function of the sensor can be configuredAdditional possible settings via IO-Link |
| BU 3 | - (M) |
| BK 4 | QL1/C Digital output, light switching, object present → output Q_{L1} LOW ⁴⁾ The pin 4 function of the sensor can be configuredAdditional possible settings via IO-Link |

¹⁾ Limit values.

²⁾ Signal transit time with resistive load in switching mode.

³⁾ With light/dark ratio 1:1.

⁴⁾ This switching output must not be connected to another output.

Mechanical data

| | |
|-------------------------------|--|
| Housing | Rectangular |
| Dimensions (W x H x D) | 15.6 mm x 49.5 mm x 43.1 mm |
| Connection | Cable with M12 male connector, 4-pin, 315 mm |
| Connection detail | |
| Deep-freeze property | Do not bend below 0 °C |
| Conductor size | 0.14 mm ² |
| Cable diameter | ∅ 3.4 mm |
| Length of cable (L) | 275 mm |
| Bending radius | For flexible use > 12 x cable diameter |
| Bending cycles | 1,000,000 |
| Material | |
| Housing | Metal, zinc diecast |
| Front screen | Plastic, PMMA |
| Cable | PVC |
| Male connector | Plastic, VISTAL® |

| | |
|---|--------------|
| Weight | Approx. 94 g |
| Maximum tightening torque of the fixing screws | 1.4 Nm |

Ambient data

| | |
|--|---|
| Enclosure rating | IP66 (EN 60529) IP67 (EN 60529) IP69 (EN 60529) |
| Ambient operating temperature | -20 °C ... +55 °C |
| Ambient temperature, storage | -40 °C ... +70 °C |
| Warm-up time | < 15 min, Where T_U is under -10 °C |
| Typ. Ambient light immunity | Artificial light: $\leq 50,000$ lx Sunlight: $\leq 50,000$ lx |
| Shock resistance | 50 g, 11 ms (25 positive and 25 negative shocks along X, Y, Z axes, 150 total shocks (EN60068-2-27)) |
| Vibration resistance | 10 Hz ... 2,000 Hz (Amplitude 0.5 mm / 10 g, 20 sweeps per axis, for X, Y, Z axes, 1 octave/min, (EN60068-2-6)) |
| Air humidity | 35 % ... 95 %, Relative humidity (no condensation) |
| Electromagnetic compatibility (EMC) | EN 60947-5-2 |
| Resistance to cleaning agent | ECOLAB |
| UL File No. | NRKH.E181493 & NRKH7.E181493 |

Smart Task

| | |
|---------------------------------|--|
| Smart Task name | Base logics |
| Logic function | Direct AND OR |
| Timer function | Deactivated On delay Off delay ON and OFF delay Impulse (one shot) |
| Inverter | Yes |
| Switching frequency | SIO Logic: 2000 Hz ¹⁾ IOL: 1600 Hz ²⁾ |
| Response time | SIO Logic: 250 μ s ¹⁾ IOL: 300 μ s ²⁾ |
| Repeatability | SIO Logic: 120 μ s ^{1) 2)} |
| Switching signal | |
| Switching signal Q_{L1} | Switching output |
| Switching signal \bar{Q}_{L1} | Switching output |

¹⁾ Use of Smart Task functions without IO-Link communication (SIO mode).

²⁾ Use of Smart Task functions with IO-Link communication function.

Diagnosis

| | |
|-------------------------------|--------------------------------------|
| Device temperature | |
| Measuring range | Very cold, cold, moderate, warm, hot |
| Device status | Yes |
| Detailed device status | Yes |

| | |
|--|-----|
| Operating hour counter | Yes |
| Operating hours counter with reset function | Yes |
| Quality of teach | Yes |

Classifications

| | |
|-----------------------|----------|
| ECLASS 5.0 | 27270904 |
| ECLASS 5.1.4 | 27270904 |
| ECLASS 6.0 | 27270904 |
| ECLASS 6.2 | 27270904 |
| ECLASS 7.0 | 27270904 |
| ECLASS 8.0 | 27270904 |
| ECLASS 8.1 | 27270904 |
| ECLASS 9.0 | 27270904 |
| ECLASS 10.0 | 27270904 |
| ECLASS 11.0 | 27270904 |
| ECLASS 12.0 | 27270903 |
| ETIM 5.0 | EC002719 |
| ETIM 6.0 | EC002719 |
| ETIM 7.0 | EC002719 |
| ETIM 8.0 | EC002719 |
| UNSPSC 16.0901 | 39121528 |

Maßzeichnung (Dimensions in mm (inch))

Dimensional drawing (Dimensions in mm (inch))

Dimensional drawing, connection

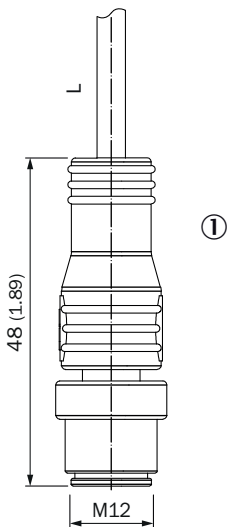

For length of cable (L), see technical data

① Cable with M12 male connector

Dimensional drawing, sensor

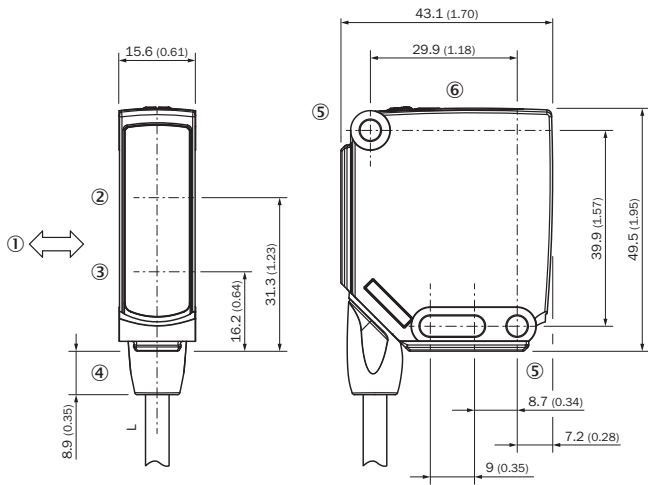

For length of cable (L), see technical data

- ① Standard direction of the material being detected
- ② Center of optical axis, receiver
- ③ Center of optical axis, sender
- ④ Connection
- ⑤ Mounting hole, \varnothing 4.2 mm
- ⑥ Display and adjustment elements

Adjustments

Display and adjustment elements

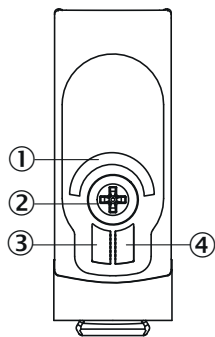

- ① LED blue
- ② Teach-Turn adjustment
- ③ LED green
- ④ LED yellow

Connection type

M12 male connector, 4-pin

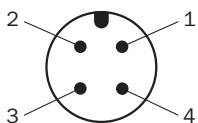

Truth table

Push-pull: PNP/NPN - light switching Q

| | Light switching Q (normally closed (upper switch), normally open (lower switch)) | |
|-------------------------|--|-----------------------------|
| | Object not present → Output HIGH | Object present → Output LOW |
| Light receive | ✓ | ✗ |
| Light receive indicator | ☉ | ✗ |
| Load resistance to L+ | ✗ | ⚠ |
| Load resistance to M | ⚠ | ✗ |

Push-pull: PNP/NPN - dark switching \bar{Q}

| | Dark switching \bar{Q} (normally open (upper switch), normally closed (lower switch)) | |
|-------------------------|---|------------------------------|
| | Object not present → Output LOW | Object present → Output HIGH |
| Light receive | ✓ | ✗ |
| Light receive indicator | ☉ | ✗ |
| Load resistance to L+ | ⚠ | ✗ |
| Load resistance to M | ✗ | ⚠ |

Characteristic curve

Minimum object height in mm (inch)

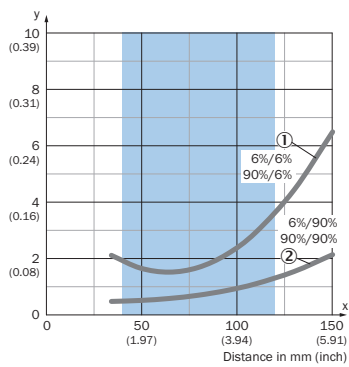

Example:
Reliable detection of the object

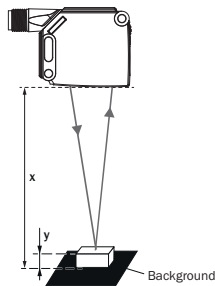

Black background (6 % remission factor)
Distance of sensor to background $x = 90$ mm
Required minimum object height $y = 2$ mm
For all objects regardless of their colors

- ① Black background, 6% remission factor
- ② White background, 90% remission factor

Light spot size

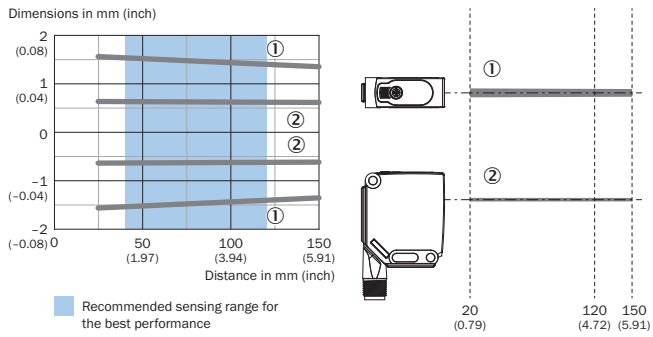

- ① Light spot horizontal
- ② Light spot vertical

Sensing range diagram

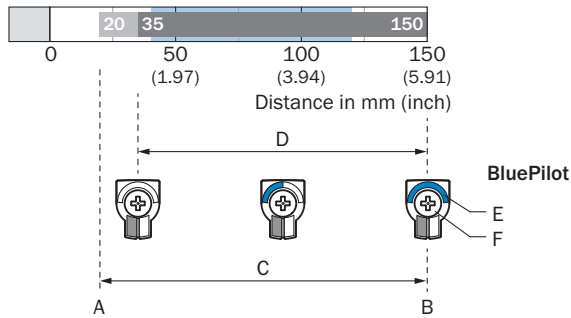







Recommended sensing range for the best performance

| | |
|---|---|
| A | Sensing range min. in mm |
| B | Sensing range max. in mm |
| C | Field of view |
| D | Adjustable switching threshold for background suppression |
| E | Sensing range indicator |
| F | Teach-Turn adjustment |

Recommended accessories

Other models and accessories → www.sick.com/W12

| | Brief description | Type | Part no. |
|-----------------------------|---|-------------|----------|
| Universal bar clamp systems | | | |
| | Plate N03 for universal clamp bracket, zinc coated, Zinc plated steel (sheet), Zinc die cast (clamping bracket), Universal clamp (5322626), mounting hardware | BEF-KHS-N03 | 2051609 |

| | Brief description | Type | Part no. |
|---|---|--------------------|----------|
|  | Mounting bar, straight, 300 mm, steel, steel, zinc coated, without mounting hardware | BEF-MS12G-B | 4056055 |
|  | Bar clamp for bar diameter of 12 mm (fixing the mounting rod), Aluminum, 2 screws M6 x 30, 2 spring discs | BEF-RMC-D12 | 5321878 |
| Mounting brackets and plates | | | |
|  | Mounting bracket, large, stainless steel, mounting hardware included | BEF-WG-W12 | 2013942 |
| | BEF-AP-W12 | BEF-AP-W12 | 2127742 |
| Plug connectors and cables | | | |
|  | <ul style="list-style-type: none"> • Connection type head A: Female connector, M12, 4-pin, straight, A-coded • Connection type head B: Flying leads • Signal type: Sensor/actuator cable • Cable: 5 m, 4-wire, PVC • Description: Sensor/actuator cable, unshielded • Application: Zones with chemicals | YF2A14-050VB3XLEAX | 2096235 |
| Terminal and alignment brackets | | | |
|  | Clamping block for dovetail mounting, Aluminum (anodised), mounting hardware included | BEF-KH-W12 | 2013285 |
| Sensor Integration Gateway | | | |
|  | <ul style="list-style-type: none"> • Further functions: Web server integrated, IIoT interface available (dual talk) • Logic editor: no • Communication interface: IO-Link, Ethernet, PROFINET, REST API, MQTT, OPC UA • Product category: IO-Link Master | SIG350-0004AP100 | 6076871 |

SICK AT A GLANCE

SICK is one of the leading manufacturers of intelligent sensors and sensor solutions for industrial applications. A unique range of products and services creates the perfect basis for controlling processes securely and efficiently, protecting individuals from accidents and preventing damage to the environment.

We have extensive experience in a wide range of industries and understand their processes and requirements. With intelligent sensors, we can deliver exactly what our customers need. In application centers in Europe, Asia and North America, system solutions are tested and optimized in accordance with customer specifications. All this makes us a reliable supplier and development partner.

Comprehensive services complete our offering: SICK LifeTime Services provide support throughout the machine life cycle and ensure safety and productivity.

For us, that is “Sensor Intelligence.”

WORLDWIDE PRESENCE:

Contacts and other locations –www.sick.com