



WS/WE34-R230

W34

COMPACT PHOTOELECTRIC SENSORS

SICK
Sensor Intelligence.



Illustration may differ



Ordering information

Type	Part no.
WS/WE34-R230	1019257

Other models and accessories → www.sick.com/W34

Detailed technical data

Features

Functional principle	Through-beam photoelectric sensor
Dimensions (W x H x D)	27 mm x 92 mm x 70 mm
Housing design (light emission)	Rectangular
Sensing range max.	0 m ... 60 m
Sensing range	0 m ... 60 m
Focus	Approx. 1°
Type of light	Visible red light
Light source	LED ¹⁾
Light spot size (distance)	Ø 700 mm (50 m)
Angle of dispersion	Approx. 1°
Wave length	660 nm
Adjustment	Potentiometer

¹⁾ Average service life: 100,000 h at T_U = +25 °C.

Mechanics/electronics

Supply voltage U_B	20 V AC/DC ... 250 V AC/DC
Power consumption	< 2 VA
Switching output	Relay, electrically isolated ¹⁾
Output function	Change-over contacts
Switching mode	Light switching, Dark switching ¹⁾
Switching mode selector	Selectable via light/dark selector

¹⁾ Provide suitable spark suppression for inductive or capacitive loads.

²⁾ With light/dark ratio 1:1.

³⁾ A = V_S connections reverse-polarity protected.

⁴⁾ C = interference suppression.

⁵⁾ Rated voltage: 250 V AC/DC.

Switching current (switching voltage)	4 A @ 250 V AC, 4 A @ 24 V DC, 0.125 A @ 250 V DC
Response time	≤ 10 ms
Switching frequency	10 Hz ²⁾
Angle of reception	Approx. 2.5°
Connection type	Terminal connection with M16 gland
Circuit protection	A ³⁾ C ⁴⁾
Protection class	II ⁵⁾
Weight	280 g
Housing material	Plastic, ABS
Enclosure rating	IP67
Ambient operating temperature	-40 °C ... +60 °C
Ambient temperature, storage	-40 °C ... +75 °C
UL File No.	NRKH.E181493 & NRKH7.E181493
Part number of individual components	2022815 WE34-R230 2022823 WS34-U230

¹⁾ Provide suitable spark suppression for inductive or capacitive loads.

²⁾ With light/dark ratio 1:1.

³⁾ A = V_S connections reverse-polarity protected.

⁴⁾ C = interference suppression.

⁵⁾ Rated voltage: 250 V AC/DC.

Safety-related parameters

MTTF_D	316 years
DC_{avg}	0 %
T_M (mission time)	20 years
B_{10d}	59,123 Switching cycles ¹⁾

¹⁾ Only for devices containing electro-mechanical components. In this case, the MTTF_D value of the entire device must be calculated from the given B_{10D} value, the number of switching cycles and the given MTTF_D value.

Classifications

ECLASS 5.0	27270901
ECLASS 5.1.4	27270901
ECLASS 6.0	27270901
ECLASS 6.2	27270901
ECLASS 7.0	27270901
ECLASS 8.0	27270901
ECLASS 8.1	27270901
ECLASS 9.0	27270901
ECLASS 10.0	27270901
ECLASS 11.0	27270901
ECLASS 12.0	27270901
ETIM 5.0	EC002716
ETIM 6.0	EC002716

ETIM 7.0	EC002716
ETIM 8.0	EC002716
UNSPSC 16.0901	39121528

Dimensional drawing (Dimensions in mm (inch))

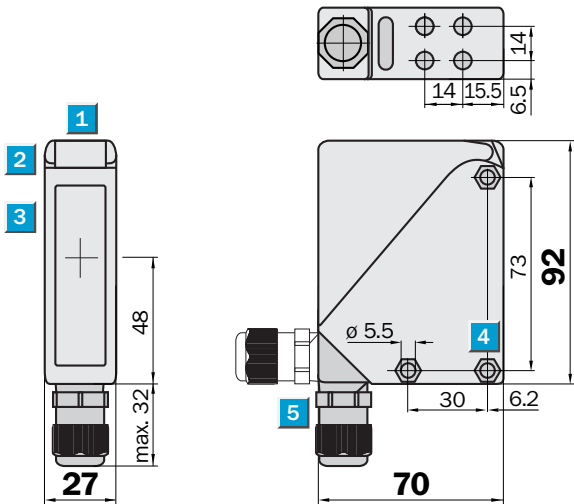

- ① Alignment sight
- ② LED signal strength indicator
- ③ Center of optical axis
- ④ Mounting hole \varnothing 5.5 mm, for M5 hexagon nuts on both sides
- ⑤ M16 screw fixing rotatable by 90°

Adjustments

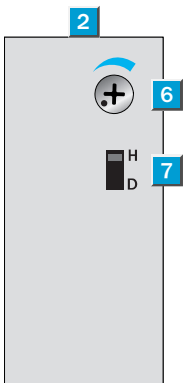

- ② LED signal strength indicator
- ⑥ Sensitivity control
- ⑦ Light/dark selector

Connection type

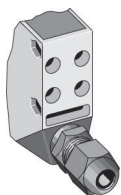

Connection diagram

Cd-127

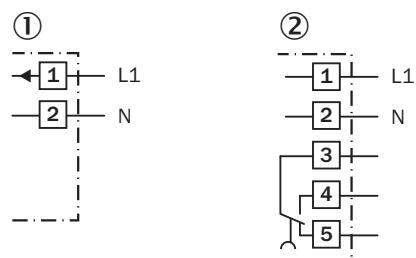

- ① Sender
- ② Receiver

Characteristic curve

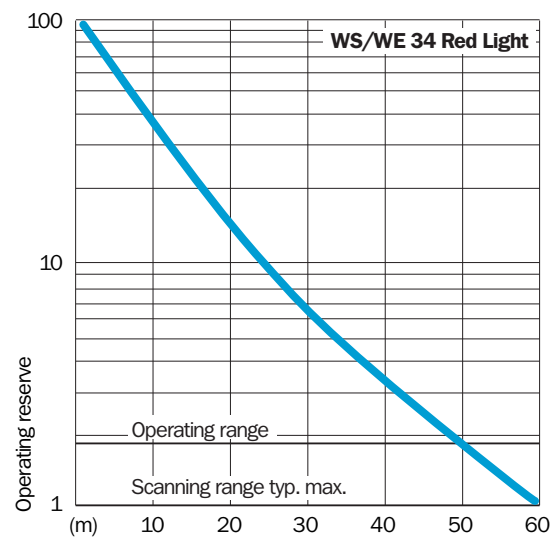

Sensing range diagram

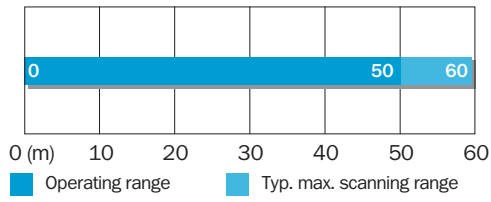

Recommended accessories

Other models and accessories → www.sick.com/W34

	Brief description	Type	Part no.
Mounting brackets and plates			
	Mounting bracket, Stainless steel (1.4301), mounting hardware included	BEF-WN-W24	2015248

SICK AT A GLANCE

SICK is one of the leading manufacturers of intelligent sensors and sensor solutions for industrial applications. A unique range of products and services creates the perfect basis for controlling processes securely and efficiently, protecting individuals from accidents and preventing damage to the environment.

We have extensive experience in a wide range of industries and understand their processes and requirements. With intelligent sensors, we can deliver exactly what our customers need. In application centers in Europe, Asia and North America, system solutions are tested and optimized in accordance with customer specifications. All this makes us a reliable supplier and development partner.

Comprehensive services complete our offering: SICK LifeTime Services provide support throughout the machine life cycle and ensure safety and productivity.

For us, that is “Sensor Intelligence.”

WORLDWIDE PRESENCE:

Contacts and other locations –www.sick.com