



Product designation				Auxiliary contactor
Product type designation				BF00
<b>Contact characteristics</b>				
Number of poles	Nr.			4
Rated insulation voltage $U_i$ IEC/EN	V			690
Rated impulse withstand voltage $U_{imp}$	kV			6
Operational frequency	min	Hz	25	
	max	Hz	400	
IEC Conventional free air thermal current $I_{th}$	A			10
Operational current $I_e$	AC-1 ( $\leq 55^\circ\text{C}$ )		A	0
	gG (IEC)		A	25
Tightening torque for terminals	min	Nm	1.5	
	max	Nm	1.8	
	min	lbin	1.1	
	max	lbin	1.5	
Tightening torque for coil terminal	min	Nm	0.8	
	max	Nm	1	
	min	lbin	0.8	
	max	lbin	0.74	
Max number of wires simultaneously connectable	Nr.			2
Conductor section	AWG/Kcmil			
	max		10	
Flexible w/o lug conductor section	min	mm <sup>2</sup>	1	
	max	mm <sup>2</sup>	6	
Flexible c/w lug conductor section	min	mm <sup>2</sup>	1	
	max	mm <sup>2</sup>	4	
Flexible with insulated spade lug conductor section	min	mm <sup>2</sup>	1	
	max	mm <sup>2</sup>	4	
Power terminal protection according to IEC/EN 60529				IP20 when properly wired
<b>Mechanical features</b>				
Operating position	normal allowable		Vertical plan $\pm 30^\circ$	

Fixing				Screw / DIN rail 35mm
Weight	g			496
Conductor section	AWG/kcmil conductor section			
	max			10
<b>Auxiliary contact characteristics</b>				
Thermal current I <sub>th</sub>	A			10
IEC/EN 60947-5-1 designation				A600 - P600
Operating current AC15				
	230V	A		3
	400V	A		1.9
	500V	A		1.4
Operating current DC12				
	110V	A		5.7
Operating current DC13				
	24V	A		5.7
	48V	A		2.9
	60V	A		2.3
	110V	A		1.25
	125V	A		1.1
	220V	A		0.55
	600V	A		0.2
<b>Operations</b>				
Mechanical life	cycles			20000000
<b>Safety related data</b>				
Performance level B10d according to EN/ISO 13489-1	mechanical load			cycles 20000000
Mirror contacts according to IEC/EN 60947-4-1				YES
EMC compatibility				yes
<b>DC coil operating</b>				
DC rated control voltage	V			12
DC operating voltage				
	pick-up			
	min	%Us		70
	max	%Us		125
	drop-out			
	min	%Us		10
	max	%Us		40
Average coil consumption ≤20°C				
	in-rush	W		5.4
	holding	W		5.4
<b>Max cycles frequency</b>				
Mechanical operation	cycles/h			3600
<b>Operating times</b>				
Average time for U <sub>s</sub> control				
	in DC			
	Closing NO			
	min	ms		54
	max	ms		66
	Opening NO			
	min	ms		14
	max	ms		17

Closing NC	min	ms	24
	max	ms	30
Opening NC	min	ms	47
	max	ms	57

**UL technical data**

General USE

Auxiliary contacts

AC current A 10

Contact rating of auxiliary contacts according to UL

A600 - P600

**Ambient conditions**

Temperature

Operating temperature

min °C -50  
 max °C 70

Storage temperature

min °C -60  
 max °C 80

Max altitude

m 3000

**Resistance & Protection**

Pollution degree

3

**Dimensions**

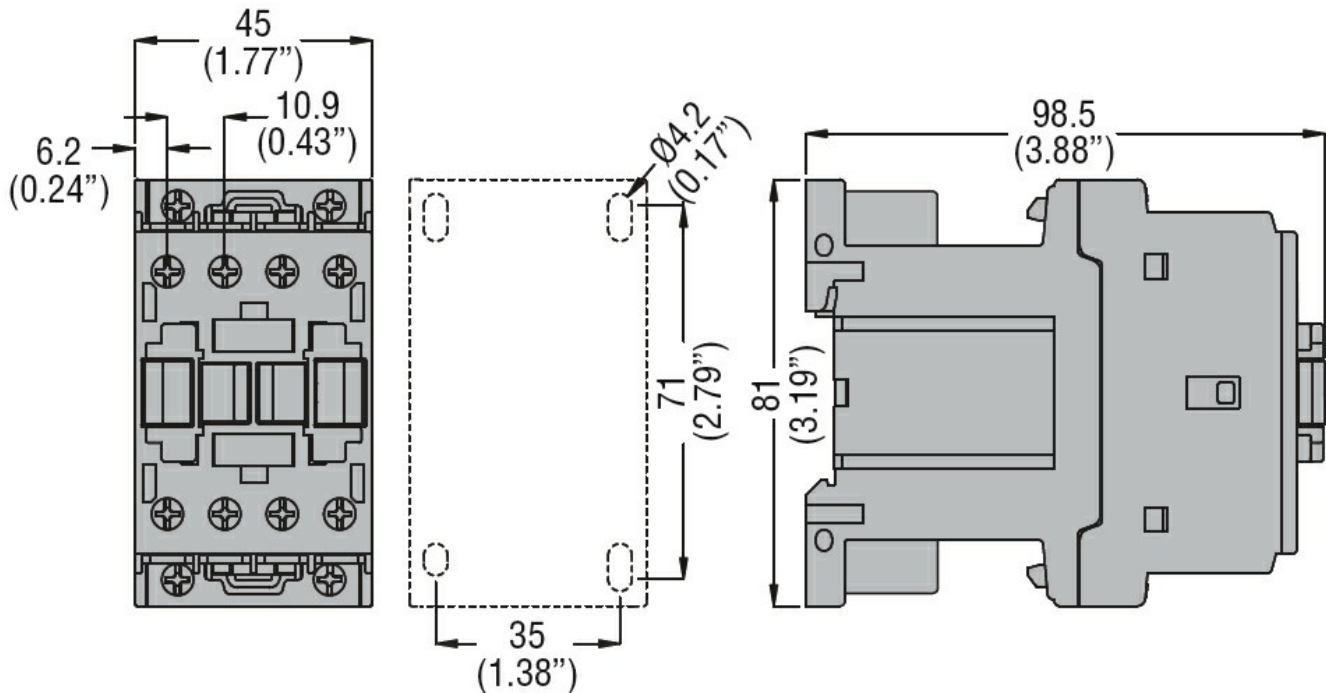

**Wiring diagrams**

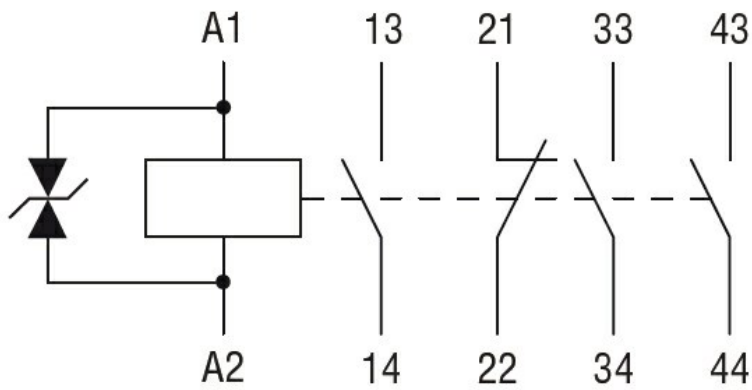

**Certifications and compliance**

Compliance

CSA C22.2 n° 60947-1

CSA C22.2 n° 60947-5-1

IEC/EN 60947-1

IEC/EN 60947-5-1

UL 60947-1

UL 60947-5-1

Certificates

CCC

cULus

EAC

**ETIM classification**

ETIM 8.0

EC000196 -  
 Contactor relay