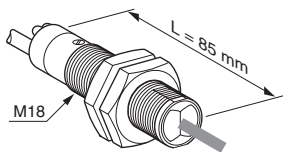
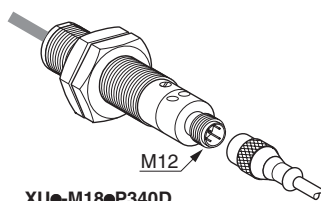

Photo-electric sensor M18, metal case, d.c. supply, solid state output
 Détecteur photoélectrique métallique M18, alimentation en courant continu, sortie statique
 Photoelektronische Sensoren M18, Gehäuse aus Metall, Geräte für Gleichspannung, Ausgang : statisch
 Detectores fotoeléctricos M18, Cuerpo metálico, alimentación en corriente continua, salida estática
 Interruttori fotoelettrici M18, Corpo in metallo, alimentazione in corrente continua, uscita statica
 Detectores foto-eléctricos M18, caixa metálica, alimentação em corrente contínua, saída estática

Max.tightening torque /
 Couple de serrage maxi. /
 Anzugsmoment maxi /
 Par de apriete máximo /
 Coppia di serraggio massima /
 Binário máximo de aperto



XU-M18-P340



XU-M18-P340D

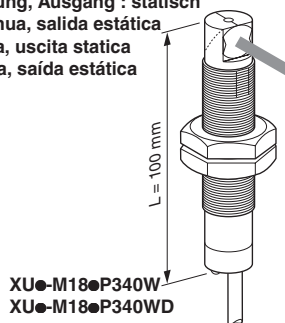

XU-M18-P340W
 XU-M18-P340WD

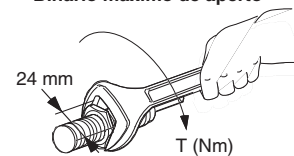

XU-N18 : T = 15 Nm
 XU-P18 : T = 5 Nm

Electrical installation / Mise en œuvre électrique / Elektrische Installation / Instalación eléctrica / Messa in opera elettrica / Instalação eléctrica

Light on (1)

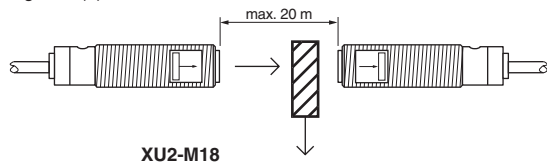

XU2-M18

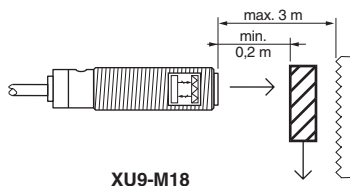

XU9-M18

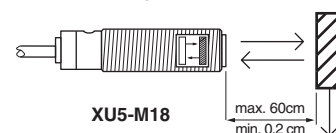

XU5-M18

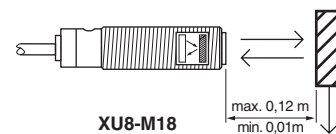

XU8-M18

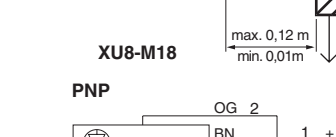
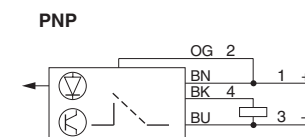
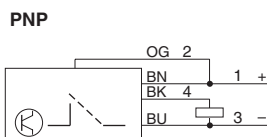
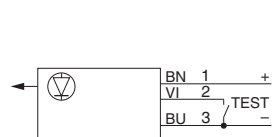

Test input

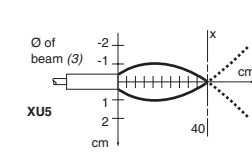
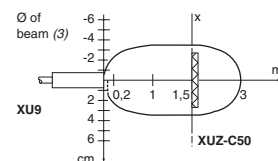
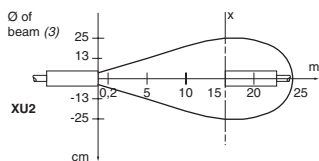
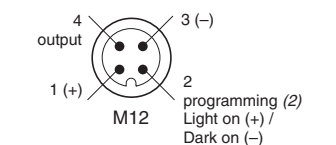
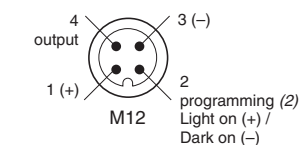
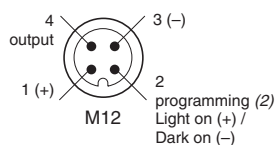
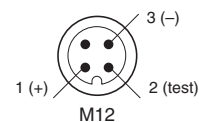
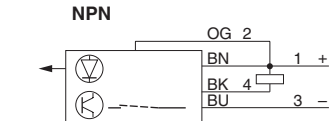
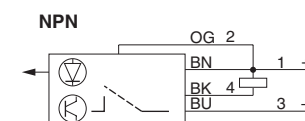
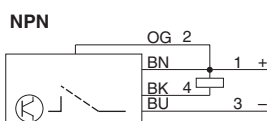
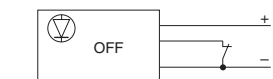
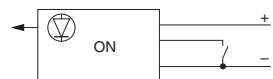

Verification of correct operation /
 Contrôle de bon fonctionnement /
 Funktionsanzeige /
 Control de funcionamiento correcto /
 Controllo corretto funzionamento /
 Controllo de bom funcionamento.

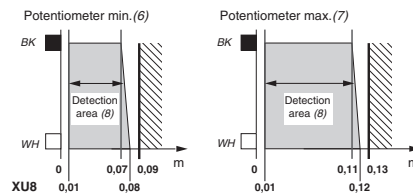
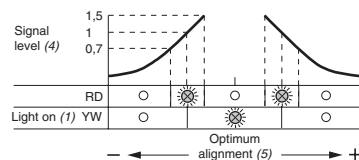

	RD	Red	Rouge	Rot	Rojo	Rosso	Vermelho
	YW	Yellow	Jaune	Gerb	Amarillo	Giallo	Amarelo
	BN	Brown	Brun	Brau	Marrón	Marrone	Castanho
	BU	Blue	Bleu	Blau	Azul	Blu	Azul
	BK	Black	Noir	Schwarz	Negro	Nero	Preto
	OG	Orange	Orange	Orange	Naranja	Arancio	Laranja
WH	White	Blanc	Weiß	Blanco	Bianco	Branco	
VI	Violet	Violet	Violett	Violeta	Viola	Violeta	

Voltage limits / limites de tension / Betriebsspannung / Límites de tensión / Limiti di rensione / Limite de tensão	10...30 V
Load switching capacity / Courant commuté / Schaltstrom / Intensidad conmutada / Corrente commutata / Corrente comutada	≤ 100 mA
Current consumption / Puissance consommée / Leistung / Potencias consumida / Potenza consumata / Potenza consumida	≤ 35 mA (XU5/8/9) ≤ 50 mA (XU2)
Maximum switching frequency / Fréquence maxi de commutation / Maximale Schaltfrequenz f / Frecuencia máxima de commutación / Frecuencia di commutazione max. / Frequência máxima de comutação	500 Hz

Installation precautions / Précautions de mise en œuvre / Vorsicht bei der Inbetriebnahme / Precauciones para la instalación / Consigli di messa in opera / Precaução de instalação

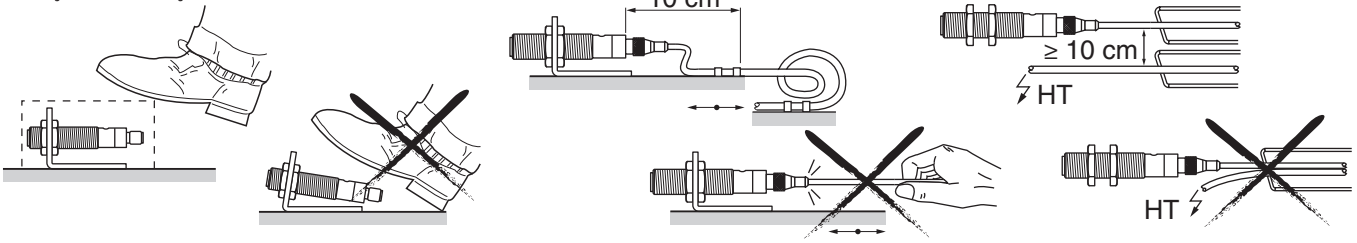

Fixing accessories / Accessoires de fixation / Befestigungszubehör / Accesorios de fijación / Accessori di fissaggio / Acessórios de fixação

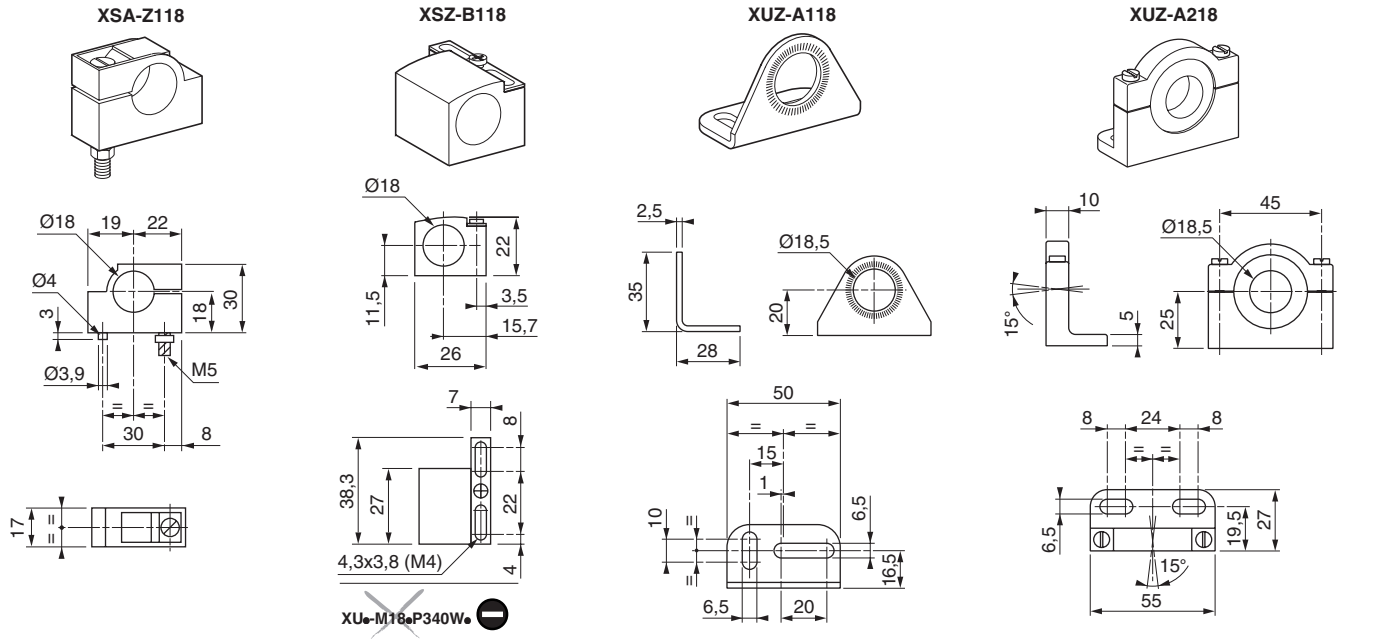

~~XU-M18-P340W~~

Machine cabling accessories / Constituants de câblage machines / Zubehör für Maschinen-Anschlußtechnik / Constituyentes de conexianado / Accessori di cablaggio / Constituintes de cablagem

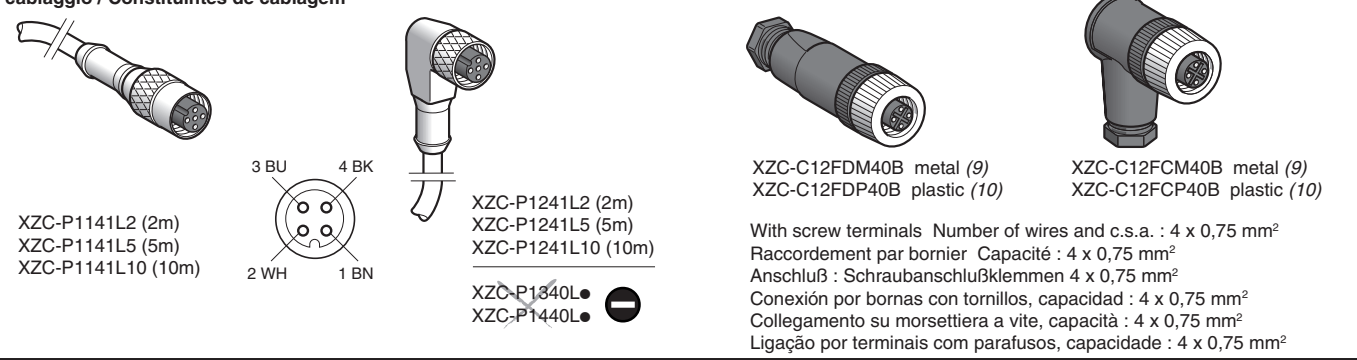

Reflector / Réflecteur / Reflektor / Reflector / Catarifrangente / Reflector

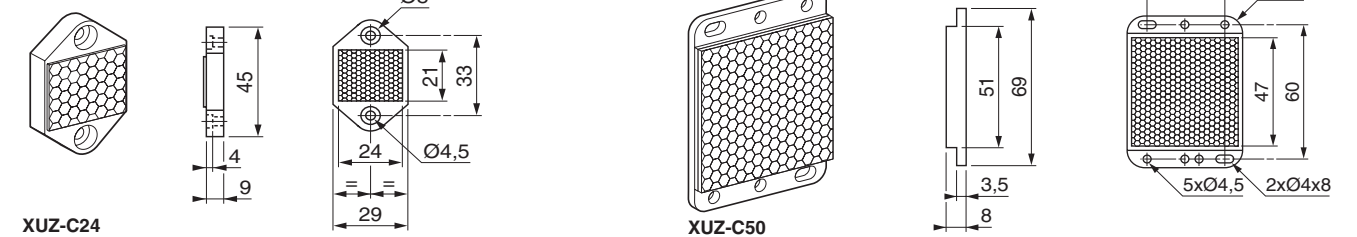

- (1) Fonction claire / Hellschaltung / Función luz / Luce-on / Comutação clara.
- (2) Programmation clair-sombre / Programmierung Hell-Dunkel / Programación luz-sombra / Programmazione chiaro-buio / Programação clara-sombra.
- (3) Ø du faisceau / Ø Lichtstrahl / Ø del haz / Ø del fascio / Ø do feixe.
- (4) Niveau du signal / Signalpegel / Nivel de la señal / Livello del segnale / Nivel do sinal.
- (5) Alignement optimum / Optimale Einstellung / Alineación óptima / Alineamento ottimale / Alinhamento óptimo.
- (6) Potentiomètre au mini. / Potentiometer auf Mini. / Potenciometro al mini. / Potenziometro al minimo / Potenziometro no mini.
- (7) Potentiomètre au maxi. / Potentiometer auf Maxi. / Potenciometro al máxi. / Potenziometro al massimo / Potenziometro no máxi.
- (8) Plage de détection / Erfassungsbereich / Zona de detección / Campo di rilevamento / Zona de detecção.
- (9) métal / metall / metálico / metallica / metálica.
- (10) plastique / Kunststoff / plástico / plastica / plástico.

UL and CSA Approvals :
Applicable on proximity switches bearing the UL and CSA Listing marks only
Enclosure : Type 12,4X indoor use only.