



Product designation	Selector switch actuator key - 3 position
Product type designation	LPCS37

**General characteristics**

Colour	Black
Type of positions	Selector switch
Material	Polyamide
IEC degree of protection	IP66, IP67 and IP69K

**Mechanical features**

Mechanical life	cycles	1000000
Mounting adapter		LPXAU120
Weight	g	60

**UL technical data**

UL degree of protection	Type1, 2, 3R, 4, 4X, 12, 12K
-------------------------	------------------------------

**Ambient conditions**

Temperature			
Operating temperature			
	min	°C	-25
	max	°C	+70
Storage temperature			
	min	°C	-40
	max	°C	+85

**Dimensions**

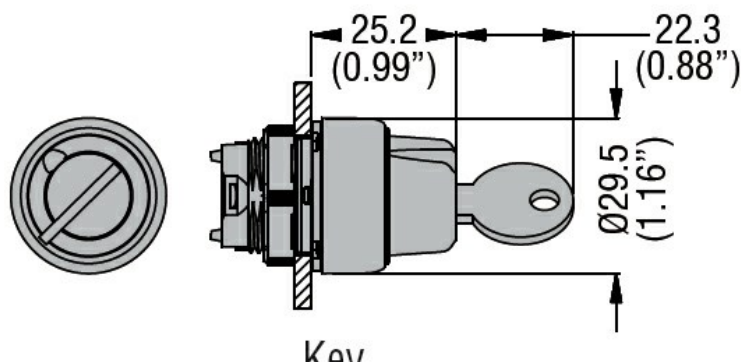

**Certifications and compliance**

Compliance	CSA C22.2 n° 14
	IEC/EN/BS 60947-1
	IEC/EN/BS 60947-5-1
	UL508
Certificates	CCC
	cULus

ETIM classification

ETIM 8.0

EC000222 -  
Front element for  
selector switch