



YMRJA8-050EG1MRJA8

Industrial Ethernet cables and fieldbus cables

PLUG CONNECTORS AND CABLES

SICK
Sensor Intelligence.



Ordering information

Type	Part no.
YMRJA8-050EG1MRJA8	2106264

Other models and accessories → www.sick.com/Industrial_Ethernet_cables_and_fieldbus_cables



Detailed technical data

Technical specifications

Accessory group	Plug connectors and cables
Accessory family	Connection cables
Connection type head A	Male connector, RJ45, 8-pin, straight
Connection type head B	Male connector, RJ45, 8-pin, straight
Connector material	TPU
Connector color	Black
Cable	5 m, 8-wire, PUR, halogen-free
Jacket material	PUR, halogen-free
Jacket color	Green
Cable diameter	6.4 mm
Conductor cross section	0,14 mm ²
Shielding	Shielded
Bending radius	
Flexible use	> 10 x cable diameter
Stationary position	> 8 x cable diameter
Nominal voltage, cable	125 V AC
Test voltage, cable	1,000 V AC
Reference voltage	48 V AC 60 V DC
Signal type	Ethernet, Gigabit Ethernet
Transmission characteristics	CAT6A
Data transmission rate	≤ 10 Gbit/s
Application	Zones with oils and lubricants
Authorizations	CE UL
UL File No.	E513908
Enclosure rating	IP20
Ambient operating temperature	
Stationary position	-40 °C ... +80 °C

	Head	-25 °C ... +85 °C
Contamination rating		3
Insulation resistance		> 100 mΩ
Specific insulation resistance		< 30 mΩ
Thermal resistance, piping		Flame retardant acc. to UL 1581 Section 1090, Section 1100 (FT2), Section 1080 (VW-1) / IEC 60332-1-2

Classifications

ECLASS 5.0	19030312
ECLASS 5.1.4	19030312
ECLASS 6.0	27060304
ECLASS 6.2	27060304
ECLASS 7.0	27060304
ECLASS 8.0	27060304
ECLASS 8.1	27060304
ECLASS 9.0	27060304
ECLASS 10.0	27060304
ECLASS 11.0	27060304
ECLASS 12.0	27060304
ETIM 5.0	EC000830
ETIM 6.0	EC000830
ETIM 7.0	EC003249
ETIM 8.0	EC003249
UNSPSC 16.0901	26121604

Dimensional drawing (Dimensions in mm (inch))

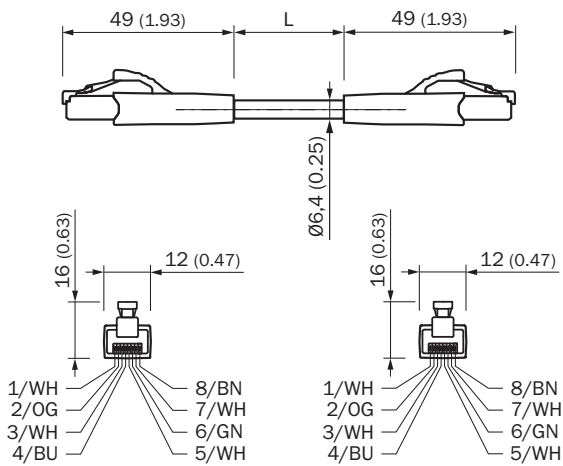

SICK AT A GLANCE

SICK is one of the leading manufacturers of intelligent sensors and sensor solutions for industrial applications. A unique range of products and services creates the perfect basis for controlling processes securely and efficiently, protecting individuals from accidents and preventing damage to the environment.

We have extensive experience in a wide range of industries and understand their processes and requirements. With intelligent sensors, we can deliver exactly what our customers need. In application centers in Europe, Asia and North America, system solutions are tested and optimized in accordance with customer specifications. All this makes us a reliable supplier and development partner.

Comprehensive services complete our offering: SICK LifeTime Services provide support throughout the machine life cycle and ensure safety and productivity.

For us, that is “Sensor Intelligence.”

WORLDWIDE PRESENCE:

Contacts and other locations –www.sick.com