

Part number

# MBV 16.325



Hood, BIG series, with 4 pegs, M25 x 3 3 top cable entries, size "77.27"

Product description		Material properties	
<b>Product type</b>	Hood	<b>Other materials</b>	Gasket: NBR
<b>Series</b>	BIG	<b>Colour</b>	RAL 7040 grey
<b>Closing type</b>	With 4 pegs	<b>RoHs conformity</b>	Compliant
<b>Size</b>	Size 77.27	<b>China RoHs - EFUP</b>	E
<b>Cable entry</b>	3 top cable entries M25 x 3	<b>REACH SVHC substances</b>	No
Technical data		Approvals / Standards	
<b>IP degree of protection</b>	IP66	<b>Certifications</b>	DNV, BV
Further technical details		<b>UL</b>	ECBT2
<b>Weight</b>	592,00 g	<b>cUL</b>	ECBT8
<b>Operating temperature range (min, max)</b>	-40°C...+125°C	General ordering information	
		<b>EAN13 code</b>	8015747187015
		<b>eCl@ss 8.1</b>	27440202
		<b>ETIM 7.0</b>	EC000437
		Packaging Information	
		<b>Packaging length</b>	130,00 mm
		<b>Packaging height</b>	145,00 mm
		<b>Packaging width</b>	300,00 mm
		<b>Packaging weight</b>	2,54 kg
		<b>Packaging volume</b>	5,66 dm <sup>3</sup>
		<b>Packaging description</b>	Carton box
		<b>Packaging quantity</b>	4 Pcs
		<b>Packaging EAN code</b>	8015747220873
		<b>Sub-packaging weight</b>	0,64 kg
		<b>Sub-packaging description</b>	Plastic packaging
		<b>Sub-packaging quantity</b>	1 Pcs
		<b>Sub-packaging EAN barcode</b>	8015747036085

Part number

# MBV 16.325



## Catalogue drawings

MBV 16.325

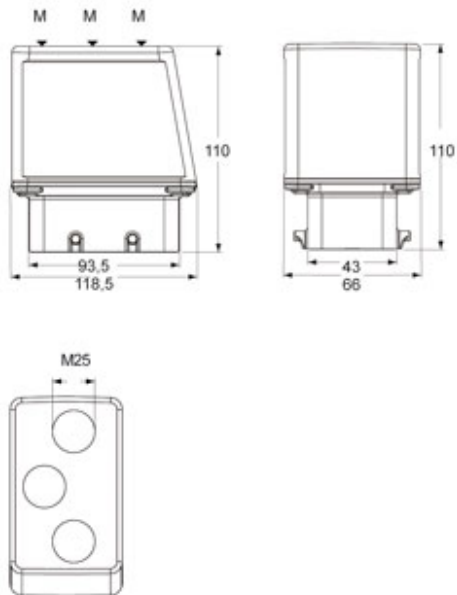

---

## Notes

Dimensions shown in mm are not binding and may be changed without notice.

---