



OD2-P50W10C2

OD Value

DISPLACEMENT MEASUREMENT SENSORS

SICK
Sensor Intelligence.



Illustration may differ



Ordering information

| Type | Part no. |
|--------------|----------|
| OD2-P50W10C2 | 6036595 |

Other models and accessories → www.sick.com/OD_Value

Detailed technical data

Mechanics/electronics

| | |
|--|---|
| Supply voltage V_s | DC 12 V ... 24 V |
| Power consumption | ≤ 2.88 W ¹⁾ |
| Warm-up time | ≤ 30 min |
| Housing material | Plastic (PBT) |
| Window material | Plastic (PMMA) |
| Connection type | Cable, 2 m |
| Indication | Distance bar graph, up to 8 status LEDs |
| Weight | 70 g |
| Dimensions (W x H x D) | 20.4 mm x 60 mm x 50 mm |
| Enclosure rating | IP67 |
| Protection class | III |

¹⁾ Without load, with current output.

Safety-related parameters

| | |
|-------------------------|-----------|
| MTTF_D | 101 years |
| DC_{avg} | 0% |

Performance

| | |
|---------------------------------------|-------------------------------|
| Measurement range min ... max: | 40 mm ... 60 mm ¹⁾ |
| Target | Natural objects |

¹⁾ 6% ... 90% remission factor.

²⁾ Measurement on 90 % remission (ceramic, white).

³⁾ At averaging function medium.

⁴⁾ Constant ambient conditions.

⁵⁾ When calibrated in the application regularly.

⁶⁾ Wavelength: 655 nm, max. output: 1 mW.

| | |
|--|--|
| Repeatability | 5 μm ^{2) 3) 4)} |
| Linearity | $\pm 20 \mu\text{m}$ ^{2) 3) 5)} |
| Response time | $\geq 1 \text{ ms}$ |
| Measuring frequency | $\leq 2 \text{ kHz}$ ¹⁾ |
| Output time | $\geq 0.5 \text{ ms}$ |
| Light source | Laser, red visible red light |
| Laser class | 2 (IEC 60825-1:2014, EN 60825-1:2014) ⁶⁾ |
| Typ. light spot size (distance) | 0.5 mm x 1 mm (50 mm) |
| Additional function | Mean-value setting 1 ... 64x, automatic sensitivity adjustment, Teach-in of digital output, In-vertable switching output, multifunctional input: laser-off / external teach-in / trigger, switching mode: distance to object (DtO), switching mode: window (Wnd) |

¹⁾ 6% ... 90% remission factor.

²⁾ Measurement on 90 % remission (ceramic, white).

³⁾ At averaging function medium.

⁴⁾ Constant ambient conditions.

⁵⁾ When calibrated in the application regularly.

⁶⁾ Wavelength: 655 nm, max. output: 1 mW.

Interfaces

| | | |
|-----------------------------------|------------------------------|-----------------------|
| Digital output | Number | 2 ¹⁾ |
| | Type | PNP |
| | Maximum output current I_A | $\leq 100 \text{ mA}$ |
| Multifunctional input (MF) | | 1 x MF ²⁾ |

¹⁾ PNP: HIGH = $V_S - (< 2 \text{ V})$ / LOW = $< 2 \text{ V}$; NPN: HIGH = $< 2 \text{ V}$ / LOW = V_S .

²⁾ MF can be used as laser-off, trigger, external teach-in, or deactivated; response time $\leq 3 \text{ ms}$.

Ambient data

| | |
|---|---|
| Ambient temperature, operation | -10 °C ... +40 °C |
| Ambient temperature, storage | -20 °C ... +60 °C |
| Relative air humidity (non-condensing) | 35 % ... 95 % |
| Temperature drift | $\pm 0.08 \text{ % FS/K}$ (FS = Full Scale = Measuring range of sensor) |
| Typ. Ambient light immunity | Artificial light: $\leq 3,000 \text{ lx}$ Sunlight: $\leq 10,000 \text{ lx}$ |
| Vibration resistance | 10 Hz ... 55 Hz (amplitude 1.5 mm, x-, y-, z-axis 2 hours each) |
| Shock resistance | 50 G (x, y, z axis 3 times each) |

Classifications

| | |
|---------------------|----------|
| eCl@ss 5.0 | 27270801 |
| eCl@ss 5.1.4 | 27270801 |
| eCl@ss 6.0 | 27270801 |
| eCl@ss 6.2 | 27270801 |
| eCl@ss 7.0 | 27270801 |
| eCl@ss 8.0 | 27270801 |
| eCl@ss 8.1 | 27270801 |

OD2-P50W10C2 | OD Value

DISPLACEMENT MEASUREMENT SENSORS

| | |
|-----------------------|----------|
| eCl@ss 9.0 | 27270801 |
| eCl@ss 10.0 | 27270801 |
| eCl@ss 11.0 | 27270801 |
| eCl@ss 12.0 | 27270916 |
| ETIM 5.0 | EC001825 |
| ETIM 6.0 | EC001825 |
| ETIM 7.0 | EC001825 |
| ETIM 8.0 | EC001825 |
| UNSPSC 16.0901 | 41111613 |

Dimensional drawing (Dimensions in mm (inch))

OD2-x50W10xx

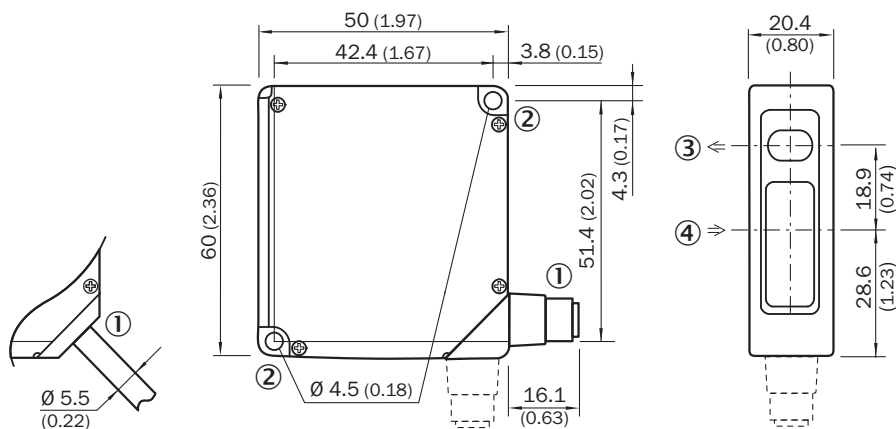

- ① 2 m cable or M12 connector; 90° rotatable
- ② Mounting hole, \varnothing 4.5 mm
- ③ Optical axis, sender
- ④ Optical axis, receiver

Connection type

OD2-xxxxxA2 OD2-xxxxxC2 OD2-xxxxxI2 OD2-xxxxxU2 cable

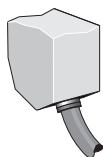

Connection diagram

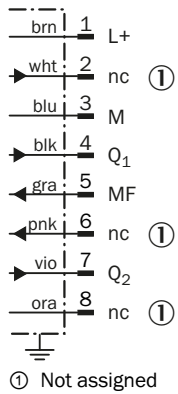

Adjustment possible

OD2-xxxxxCx

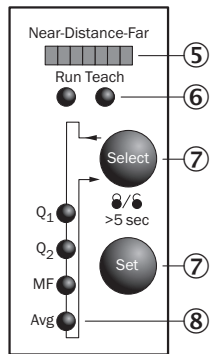

- ⑤ Distance indicator
- ⑥ Mode indicator (Run/Teach)
- ⑦ Control elements
- ⑧ Status indicator in- and outputs (Run-mode)/menu indicator (Teach-mode)

Light spot size

OD2-x50W10xx

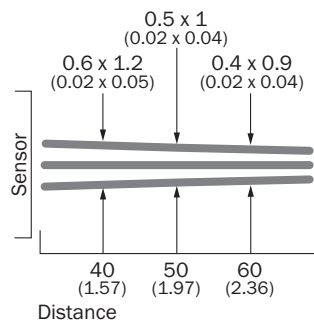

All dimensions in mm (inch)

Linearity

OD2-x50xxxx

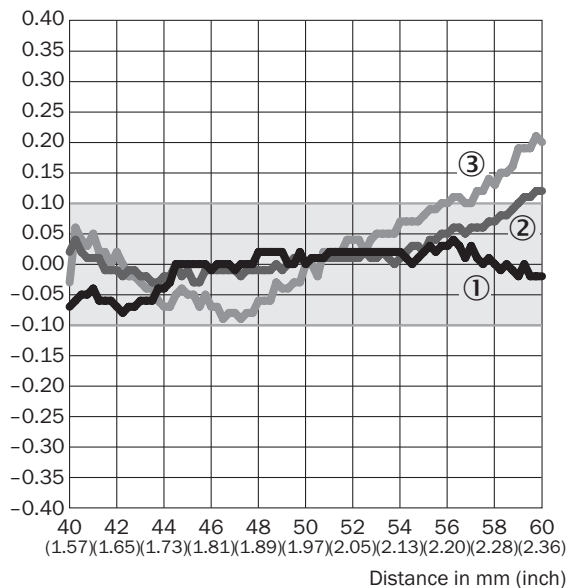

Linearity [%FS]



- ① White ceramic
- ② Black paper
- ③ Stainless steel

Recommended accessories

Other models and accessories → www.sick.com/OD_Value

| | Brief description | Type | Part no. |
|---|--|----------------|----------|
| Mounting brackets and plates | | | |
|  | Stainless-steel mounting bracket, stainless steel | BEF-WN-OD1000 | 4089813 |
| Plug connectors and cables | | | |
|  | Head A: female connector, M12, 8-pin, straight Head B: Flying leads Cable: Sensor/actuator cable, special color code, PVC, shielded, 2 m | DOL-1208-G02MF | 6020663 |

Recommended services

Additional services → www.sick.com/OD_Value

| | Type | Part no. |
|--|--|----------|
| Commissioning | | |
| <ul style="list-style-type: none"> • Product area: Displacement measurement sensors • Range of services: Inspection of connection and mounting, optimization of parameters of SICK product as well as tests, set-up of previously defined functions of the scaling of the analog measuring range, switching point position, hysteresis, measuring frequency, measured value filter, signal quality, evaluation function, or communication interface • Travel expenses: The prices do not include travel costs such as hotel, flight, travel time and expenses. • Duration: Additional work will be invoiced separately | DT20 Hi/OD/OL commissioning | 1612241 |
| Extended warranty | | |
| <ul style="list-style-type: none"> • Product area: Identification solutions, machine vision, Distance sensors, Detection and ranging solutions • Range of services: The services correspond to the scope of the statutory manufacturer warranty (SICK general terms of delivery). • Duration: Five-year warranty from delivery date. | Extended warranty for a total of five years from delivery date | 1680671 |

SICK AT A GLANCE

SICK is one of the leading manufacturers of intelligent sensors and sensor solutions for industrial applications. A unique range of products and services creates the perfect basis for controlling processes securely and efficiently, protecting individuals from accidents and preventing damage to the environment.

We have extensive experience in a wide range of industries and understand their processes and requirements. With intelligent sensors, we can deliver exactly what our customers need. In application centers in Europe, Asia and North America, system solutions are tested and optimized in accordance with customer specifications. All this makes us a reliable supplier and development partner.

Comprehensive services complete our offering: SICK LifeTime Services provide support throughout the machine life cycle and ensure safety and productivity.

For us, that is “Sensor Intelligence.”

WORLDWIDE PRESENCE:

Contacts and other locations –www.sick.com