



MAG-O-174-05

SICK
Sensor Intelligence.



Ordering information

Type	Part no.
MAG-O-174-05	2112713

Other models and accessories → www.sick.com/

Detailed technical data

Technical specifications

Accessory group	Magnets
Description	Position magnet for magnetostrictive linear encoders Installation: in hydraulic cylinder using corrugated spring washer SICK part no. 2116431 Temperature range: -30 °C ... +95 °C Dimensions: 17.4x12x10.6 mm Media: lubricants, hydraulic oils, no aggressive fluids (e.g., acids or bases)
Items supplied	5 pieces
Diameter	17.4 mm
Housing color	Black

Classifications

eCl@ss 5.0	27279209
eCl@ss 5.1.4	27279209
eCl@ss 6.0	27279209
eCl@ss 6.2	27279209
eCl@ss 7.0	27279209
eCl@ss 8.0	27279209
eCl@ss 8.1	27279209
eCl@ss 9.0	27272492
eCl@ss 10.0	27272492
eCl@ss 11.0	27272492
eCl@ss 12.0	27274392
ETIM 5.0	EC002594
ETIM 6.0	EC002594
ETIM 7.0	EC002594
ETIM 8.0	EC002594
UNSPSC 16.0901	39122245

Dimensional drawing (Dimensions in mm (inch))

Position magnet

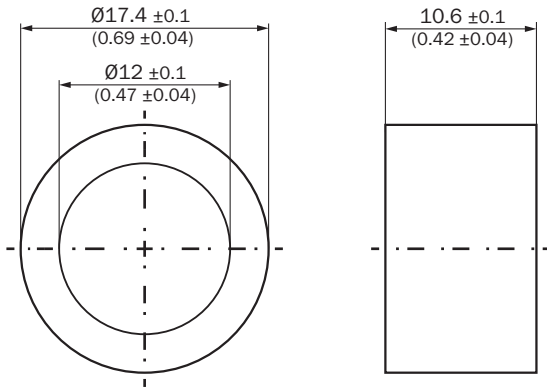

SICK AT A GLANCE

SICK is one of the leading manufacturers of intelligent sensors and sensor solutions for industrial applications. A unique range of products and services creates the perfect basis for controlling processes securely and efficiently, protecting individuals from accidents and preventing damage to the environment.

We have extensive experience in a wide range of industries and understand their processes and requirements. With intelligent sensors, we can deliver exactly what our customers need. In application centers in Europe, Asia and North America, system solutions are tested and optimized in accordance with customer specifications. All this makes us a reliable supplier and development partner.

Comprehensive services complete our offering: SICK LifeTime Services provide support throughout the machine life cycle and ensure safety and productivity.

For us, that is “Sensor Intelligence.”

WORLDWIDE PRESENCE:

Contacts and other locations –www.sick.com