



# LFV330-DAGAVXMR0400

LFV300

VIBRATING LEVEL SWITCH

**SICK**  
Sensor Intelligence.



Illustration may differ



### Ordering information

Type	Part no.
LFV330-DAGAVXMR0400	6058449

Other models and accessories → [www.sick.com/LFB300](http://www.sick.com/LFB300)

### Detailed technical data

#### Features

<b>Medium</b>	Fluids
<b>Measurement</b>	Switch
<b>Probe length</b>	400 mm
<b>Process pressure</b>	-1 bar ... 64 bar
<b>Process temperature</b>	-50 °C ... +150 °C, See safety notes for ATEX devices
<b>Fill material density</b>	0.5 g/cm <sup>3</sup> ... 2.5 g/cm <sup>3</sup>
<b>ATEX approval</b>	ATEX II 1/2G Ex db IIC T6...T2 Ga/Gb +WHG
<b>Type examination</b>	DEKRA 16 ATEX 0130 X
<b>WHG approval</b>	✓

#### Performance

<b>Accuracy of sensor element</b>	± 2 mm
<b>Reproducibility</b>	≤ 1 mm
<b>Viscosity</b>	0.1 mPas ... 10,000 mPas
<b>Response time</b>	500 ms
<b>MTBF</b>	9,73*10 <sup>6</sup> h

#### Electronics

<b>Power consumption</b>	5 mA ... 30 mA
<b>Initialization time</b>	< 2 s
<b>VDE protection class 1</b>	✓
<b>Connection type</b>	M20 x 1.5
<b>Output signal</b>	Double relay (DPDT)
<b>Supply voltage</b>	Double relay (DPDT): 20 V DC ... 72 V DC / 20 V AC ... 253 V AC
<b>Hysteresis</b>	2 mm
<b>Output current</b>	> 10 µA; < 3A AC, 1A DC
<b>Inductive load</b>	750 VA 54 W
<b>Capacitive load</b>	750 VA 54 W

<b>Contact load</b>	Min. 50 mW / max. 750 VA, 54 W
<b>Enclosure rating</b>	IP66 / IP67
<b>Temperature drift</b>	0,03 mm/K

Mechanics

<b>Wetted parts</b>	Stainless steel 316L (optional Ra ≤ 0.8 µm)
<b>Process connection</b>	G 1 A PN 64
<b>Housing material</b>	Aluminum
<b>Sensor material</b>	Stainless steel 1.4404

Ambient data

<b>Ambient operating temperature</b>	-40 °C ... +70 °C
<b>Ambient temperature, storage</b>	-40 °C ... +80 °C

Classifications

<b>ECLASS 5.0</b>	27273202
<b>ECLASS 5.1.4</b>	27273202
<b>ECLASS 6.0</b>	27273202
<b>ECLASS 6.2</b>	27273202
<b>ECLASS 7.0</b>	27273202
<b>ECLASS 8.0</b>	27273202
<b>ECLASS 8.1</b>	27273202
<b>ECLASS 9.0</b>	27273202
<b>ECLASS 10.0</b>	27273202
<b>ECLASS 11.0</b>	27273202
<b>ECLASS 12.0</b>	27273106
<b>ETIM 5.0</b>	EC002654
<b>ETIM 6.0</b>	EC002654
<b>ETIM 7.0</b>	EC002654
<b>ETIM 8.0</b>	EC002654
<b>UNSPSC 16.0901</b>	41111938

Type code

LFV330 type code

<b>Certification</b>	
XX	Without approval
XA	WHG approval
CA	ATEX II 1G, 1/2G, 2G Ex ia IIC T6 Ga, Ga/Gb, Gb +WHG
DA	ATEX II 1/2G Ex db IIC T6...T2 Ga/Gb +WHG
<b>Process connection/Material (see below)</b>	
<b>Middle section / Process temperature</b>	
X	without / -50 °C ... +150 °C
T	with / -50 °C ... +250 °C
<b>Housing / Cable screw connection</b>	
P	Plastics IP 66, IP 67 / M20 x 1,5
N	Plastics IP 66, IP 67 / ½" NPT
M	Aluminium IP 66, IP 67 / M20 x 1,5
U	Aluminium IP 66, IP 67 / ½" NPT



Dimensional drawing (Dimensions in mm (inch))

LFV330

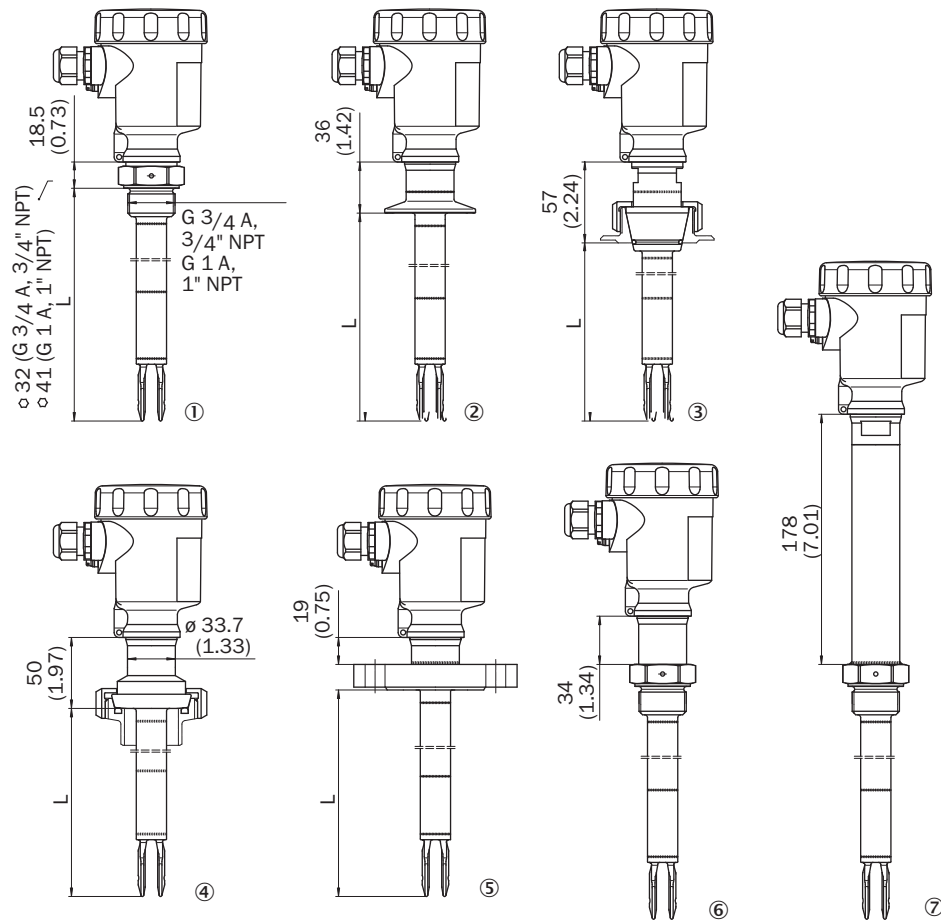

- ① Thread
- ② Tri-Clamp
- ③ DN 25 cone
- ④ Bolting D 40
- ⑤ Flange
- ⑥ Gas-tight leadthrough
- ⑦ Temperature adapter

Marking on the welded flange

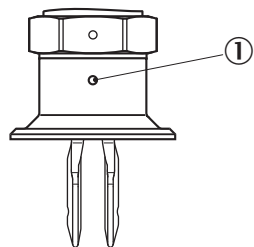

- ① Marking

### Connection diagram

Relay - electronic module



- ① Signal lamp (LED)
- ② DIL switch for mode adjustment
- ③ DIL-switch for sensitivity adjustment

Relay connection diagram (single chamber housing)

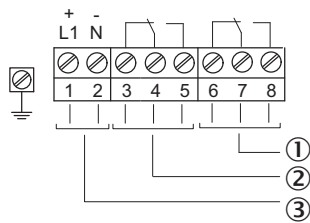

- ① Relay output
- ② Relay output
- ③ Supply voltage

### Instruction for installation

Inflowing medium



### Characteristic curve





Influence of the process temperature on the switching point



- ① Shifting of the switching point in mm (in)
- ② Process temperature in °C (°F)
- ③ Switching point at reference conditions (notch)
- ④ Tuning fork

### Recommended accessories

Other models and accessories → [www.sick.com/LFV300](http://www.sick.com/LFV300)

	Brief description	Type	Part no.
<b>Electronic modules</b>			
	Double relay (DPDT): 20 V DC ... 72 V DC / 20 ... 250 V AC	ECD-RE-LFVREL-0001	6038671
<b>Flanges</b>			
	Welded flange/welded connector, DIN11851-1, DN25 / PN40, Stainless steel 1.4404	BEF-FL-851D25-LFV2	5321527
	Welded flange/welded connector, process connection G 1, Stainless steel 1.4404	BEF-FL-GEWG10-LFV2	4054605
	Welded flange/welded connector, G 3/4 process connection, Stainless steel 1.4404	BEF-FL-GEWG34-LFV2	4054604
	Welded flange/welded connector, process connection Tri-Clamp 1", Stainless steel 1.4404	BEF-FL-TCLI10-LFV2	5321678
	Welded flange/welded connector, process connection Tri-Clamp 2", Stainless steel 1.4404	BEF-FL-TCLI20-LFV2	5321679
<b>Mounting brackets and plates</b>			
	BEF-MU-316G10-ALFV	BEF-MU-316G10-ALFV	5322463

## SICK AT A GLANCE

SICK is one of the leading manufacturers of intelligent sensors and sensor solutions for industrial applications. A unique range of products and services creates the perfect basis for controlling processes securely and efficiently, protecting individuals from accidents and preventing damage to the environment.

We have extensive experience in a wide range of industries and understand their processes and requirements. With intelligent sensors, we can deliver exactly what our customers need. In application centers in Europe, Asia and North America, system solutions are tested and optimized in accordance with customer specifications. All this makes us a reliable supplier and development partner.

Comprehensive services complete our offering: SICK LifeTime Services provide support throughout the machine life cycle and ensure safety and productivity.

For us, that is “Sensor Intelligence.”

## WORLDWIDE PRESENCE:

Contacts and other locations –[www.sick.com](http://www.sick.com)