



# IME12-04BPSZT0KP01

IME

INDUCTIVE PROXIMITY SENSORS

**SICK**  
Sensor Intelligence.



### Ordering information

| Type               | Part no. |
|--------------------|----------|
| IME12-04BPSZTOKP01 | 1046196  |

**Included in delivery:** IME12-04BPSZTOK (50), BEF-MU-M12 (50)

Other models and accessories → [www.sick.com/IME](http://www.sick.com/IME)

Illustration may differ



### Detailed technical data

#### Features

|  |  |
|--|--|
| <b>Housing</b>                             | Cylindrical thread design  |
| <b>Housing</b>                             | Short-body   |
| <b>Thread size</b>                         | M12 x 1  |
| <b>Diameter</b>                            | Ø 12 mm  |
| <b>Sensing range <math>S_n</math></b>      | 4 mm   |
| <b>Safe sensing range <math>S_a</math></b> | 3.24 mm  |
| <b>Installation type</b>                   | Flush  |
| <b>Switching frequency</b>                 | 2,000 Hz   |
| <b>Connection type</b>                     | Connector M8, 3-pin  |
| <b>Switching output</b>                    | PNP  |
| <b>Output function</b>                     | NO   |
| <b>Electrical wiring</b>                   | DC 3-wire  |
| <b>Enclosure rating</b>                    | IP67 <sup>1)</sup>   |
| <b>Special characteristic</b>              | Cap color = black<br>50 pieces package                                       |
| <b>Items supplied</b>                      | IME12-04BPSZTOK #1042973 (50 x)<br>Mounting nut, brass, nickel-plated (100x) |

<sup>1)</sup> According to EN 60529.

#### Mechanics/electronics

|                       |                     |
|-----------------------|---------------------|
| <b>Supply voltage</b> | 10 V DC ... 30 V DC |
| <b>Ripple</b>         | ≤ 10 %              |

<sup>1)</sup> At  $I_a$  max.

<sup>2)</sup> Supply voltage  $U_B$  and constant ambient temperature  $T_a$ .

<sup>3)</sup> Of  $S_r$ .

|  |                                       |
|--|---------------------------------------|
| <b>Voltage drop</b>                            | $\leq 2 \text{ V}^{1)}$               |
| <b>Time delay before availability</b>          | $\leq 100 \text{ ms}$                 |
| <b>Hysteresis</b>                              | 5 % ... 15 %                          |
| <b>Reproducibility</b>                         | $\leq 2 \%^{2) 3)}$                   |
| <b>Temperature drift (of <math>S_r</math>)</b> | $\pm 10 \%$                           |
| <b>EMC</b>                                     | According to EN 60947-5-2             |
| <b>Continuous current <math>I_a</math></b>     | $\leq 200 \text{ mA}$                 |
| <b>No load current</b>                         | $\leq 10 \text{ mA}$                  |
| <b>Short-circuit protection</b>                | ✓                                     |
| <b>Reverse polarity protection</b>             | ✓                                     |
| <b>Power-up pulse protection</b>               | ✓                                     |
| <b>Shock and vibration resistance</b>          | 30 g, 11 ms/10 Hz ... 55 Hz, 1 mm     |
| <b>Ambient operating temperature</b>           | $-25 \text{ °C} \dots +75 \text{ °C}$ |
| <b>Housing material</b>                        | Brass, nickel-plated                  |
| <b>Sensing face material</b>                   | Plastic, PA 66                        |
| <b>Housing length</b>                          | 44 mm                                 |
| <b>Thread length</b>                           | 28 mm                                 |
| <b>Tightening torque, max.</b>                 | $\leq 12 \text{ Nm}$                  |
| <b>UL File No.</b>                             | NRKH.E181493                          |

<sup>1)</sup> At  $I_a$  max.

<sup>2)</sup> Supply voltage  $U_B$  and constant ambient temperature  $T_a$ .

<sup>3)</sup> Of  $S_r$ .

### Safety-related parameters

|                                     |             |
|-------------------------------------|-------------|
| <b>MTTF<sub>D</sub></b>             | 1,735 years |
| <b>DC<sub>avg</sub></b>             | 0 %         |
| <b>T<sub>M</sub> (mission time)</b> | 20 years    |

### Reduction factors

|                                   |  |
|-----------------------------------|--|
| <b>Note</b>                       | The values are reference values which may vary |
| <b>St37 steel (Fe)</b>            | 1  |
| <b>Stainless steel (V2A, 304)</b> | Approx. 0.8                                    |
| <b>Aluminum (Al)</b>              | Approx. 0.45                                   |
| <b>Copper (Cu)</b>                | Approx. 0.4                                    |
| <b>Brass (Br)</b>                 | Approx. 0.4                                    |

### Installation note

|               |                                       |
|---------------|---------------------------------------|
| <b>Remark</b> | Associated graphic see "Installation" |
| <b>B</b>      | 24 mm                                 |
| <b>C</b>      | 12 mm                                 |
| <b>D</b>      | 12 mm                                 |
| <b>F</b>      | 32 mm                                 |

### Classifications

|                       |          |
|-----------------------|----------|
| <b>ECLASS 5.0</b>     | 27270101 |
| <b>ECLASS 5.1.4</b>   | 27270101 |
| <b>ECLASS 6.0</b>     | 27270101 |
| <b>ECLASS 6.2</b>     | 27270101 |
| <b>ECLASS 7.0</b>     | 27270101 |
| <b>ECLASS 8.0</b>     | 27270101 |
| <b>ECLASS 8.1</b>     | 27270101 |
| <b>ECLASS 9.0</b>     | 27270101 |
| <b>ECLASS 10.0</b>    | 27270101 |
| <b>ECLASS 11.0</b>    | 27270101 |
| <b>ECLASS 12.0</b>    | 27274001 |
| <b>ETIM 5.0</b>       | EC002714 |
| <b>ETIM 6.0</b>       | EC002714 |
| <b>ETIM 7.0</b>       | EC002714 |
| <b>ETIM 8.0</b>       | EC002714 |
| <b>UNSPSC 16.0901</b> | 39122230 |

### Installation note

Flush installation

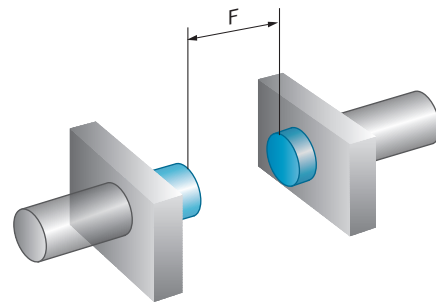
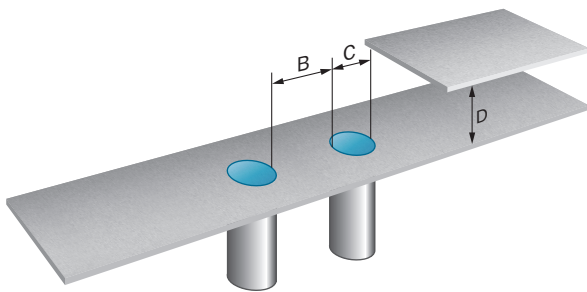

### Connection type

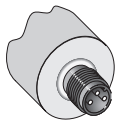

## Connection diagram

Cd-007



## Dimensional drawing (Dimensions in mm (inch))



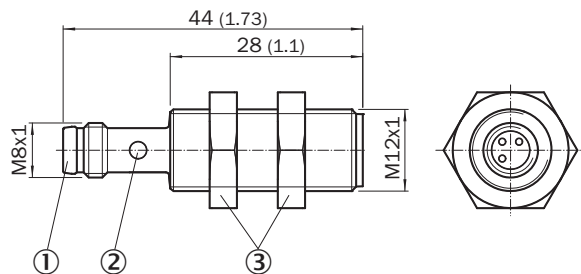

IME12 Short-body housing, connector, flush



- ① Connection
- ② Display LED
- ③ Fastening nuts (2x); width across 17, metal

## Recommended accessories

Other models and accessories → [www.sick.com/IME](http://www.sick.com/IME)

|   | Brief description  | Type               | Part no. |
|---|--|--------------------|----------|
| <b>Mounting brackets and plates</b>   |  |                    |          |
|  | Mounting plate for M12 sensors, steel, zinc coated, without mounting hardware  | BEF-WG-M12         | 5321869  |
|  | Mounting bracket for M12 sensors, steel, zinc coated, without mounting hardware  | BEF-WN-M12         | 5308447  |
| <b>Terminal and alignment brackets</b>  |  |                    |          |
|  | Clamping block for round sensors M12, without fixed stop, plastic (PA12), glass-fiber reinforced, mounting hardware included   | BEF-KH-M12         | 2051479  |
|   | Clamping block for round sensors M12, with fixed stop, plastic (PA12), glass-fiber reinforced, mounting hardware included  | BEF-KHF-M12        | 2051480  |
| <b>Others</b>   |  |                    |          |
|  | <ul style="list-style-type: none"> <li>• <b>Connection type head A:</b> Female connector, M8, 3-pin, straight, A-coded</li> <li>• <b>Connection type head B:</b> Flying leads</li> <li>• <b>Signal type:</b> Sensor/actuator cable</li> <li>• <b>Cable:</b> 2 m, 3-wire, PVC</li> <li>• <b>Description:</b> Sensor/actuator cable, unshielded</li> <li>• <b>Application:</b> Zones with chemicals</li> </ul> | YF8U13-020VA1XLEAX | 2095860  |

|   | Brief description   | Type               | Part no. |
|---|---|--------------------|----------|
|  | <ul style="list-style-type: none"> <li>• <b>Connection type head A:</b> Female connector, M8, 3-pin, straight, A-coded</li> <li>• <b>Connection type head B:</b> Flying leads</li> <li>• <b>Signal type:</b> Sensor/actuator cable</li> <li>• <b>Cable:</b> 5 m, 3-wire, PVC</li> <li>• <b>Description:</b> Sensor/actuator cable, unshielded</li> <li>• <b>Application:</b> Zones with chemicals</li> </ul>  | YF8U13-050VA1XLEAX | 2095884  |
|  | <ul style="list-style-type: none"> <li>• <b>Connection type head A:</b> Female connector, M8, 3-pin, straight, A-coded</li> <li>• <b>Connection type head B:</b> Flying leads</li> <li>• <b>Signal type:</b> Sensor/actuator cable</li> <li>• <b>Cable:</b> 10 m, 3-wire, PVC</li> <li>• <b>Description:</b> Sensor/actuator cable, unshielded</li> <li>• <b>Application:</b> Zones with chemicals</li> </ul> | YF8U13-100VA1XLEAX | 2095885  |
|  | <ul style="list-style-type: none"> <li>• <b>Connection type head A:</b> Female connector, M8, 3-pin, angled, A-coded</li> <li>• <b>Connection type head B:</b> Flying leads</li> <li>• <b>Signal type:</b> Sensor/actuator cable</li> <li>• <b>Cable:</b> 2 m, 3-wire, PVC</li> <li>• <b>Description:</b> Sensor/actuator cable, unshielded</li> <li>• <b>Application:</b> Zones with chemicals</li> </ul>    | YG8U13-020VA1XLEAX | 2096165  |
|  | <ul style="list-style-type: none"> <li>• <b>Connection type head A:</b> Female connector, M8, 3-pin, angled, A-coded</li> <li>• <b>Connection type head B:</b> Flying leads</li> <li>• <b>Signal type:</b> Sensor/actuator cable</li> <li>• <b>Cable:</b> 5 m, 3-wire, PVC</li> <li>• <b>Description:</b> Sensor/actuator cable, unshielded</li> <li>• <b>Application:</b> Zones with chemicals</li> </ul>    | YG8U13-050VA1XLEAX | 2096166  |
|  | <ul style="list-style-type: none"> <li>• <b>Connection type head A:</b> Female connector, M8, 3-pin, angled, A-coded</li> <li>• <b>Connection type head B:</b> Flying leads</li> <li>• <b>Signal type:</b> Sensor/actuator cable</li> <li>• <b>Cable:</b> 10 m, 3-wire, PVC</li> <li>• <b>Description:</b> Sensor/actuator cable, unshielded</li> <li>• <b>Application:</b> Zones with chemicals</li> </ul>   | YG8U13-100VA1XLEAX | 2096209  |

## SICK AT A GLANCE

SICK is one of the leading manufacturers of intelligent sensors and sensor solutions for industrial applications. A unique range of products and services creates the perfect basis for controlling processes securely and efficiently, protecting individuals from accidents and preventing damage to the environment.

We have extensive experience in a wide range of industries and understand their processes and requirements. With intelligent sensors, we can deliver exactly what our customers need. In application centers in Europe, Asia and North America, system solutions are tested and optimized in accordance with customer specifications. All this makes us a reliable supplier and development partner.

Comprehensive services complete our offering: SICK LifeTime Services provide support throughout the machine life cycle and ensure safety and productivity.

For us, that is “Sensor Intelligence.”

## WORLDWIDE PRESENCE:

Contacts and other locations –[www.sick.com](http://www.sick.com)