



AFS60S-S4SC262144

AFS/AFM60S Pro

ABSOLUTE ENCODERS

SICK
Sensor Intelligence.

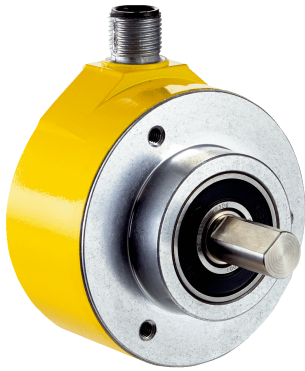

Illustration may differ



Ordering information

Type	Part no.
AFS60S-S4SC262144	1096659

Other models and accessories → www.sick.com/AFS_AFM60S_Pro

Detailed technical data

Safety-related parameters

Safety integrity level	SIL 3 (IEC 61508, IEC 61800-5-3) ¹⁾
Performance level	PL e (EN ISO 13849-1) ¹⁾
Category	3 (EN ISO 13849-1) 4 (EN ISO 13849-1)
PFH_D: Probability of dangerous failure per hour	5.5 x 10 ⁻⁹ at 40 °C ²⁾ 1.8 x 10 ⁻⁸ at 80 °C ²⁾
T_M (mission time)	20 years (EN ISO 13849-1) ³⁾
Safety-related accuracy	0.09° category 3 ⁴⁾ 0.35° category 4 ⁴⁾

¹⁾ For more detailed information on the exact configuration of your machine/unit, please consult your relevant SICK branch office.

²⁾ The values displayed apply to a temperature at the operating temperature measuring point and diagnostic degree of coverage of 99%, which must be achieved by the external evaluation unit.

³⁾ Depending on the application, the operating life may also be limited by the bearing lifetime.

⁴⁾ The safety-related accuracy indicates the maximum positioning error limit with which the safety functions can be supported.

Performance

Number of steps per revolution (max. resolution)	262,144 (18 bit)
Error limits G	0.05° ¹⁾

¹⁾ In accordance with DIN ISO 1319-1, position of the upper and lower error limit depends on the installation situation, specified value refers to a symmetrical position, i.e. deviation in upper and lower direction is the same.

Interfaces

Communication interface	SSI
Communication Interface detail	SSI + Sin/Cos
Initialization time	2 s ¹⁾
Position forming time	< 1 μs

¹⁾ Valid signals can be read once this time has elapsed.

²⁾ Set on tool side: CW with view to the shaft.

Parameterising data	Number of steps per revolution Preset position, preset position via hardware pin, counting direction, counting direction via hardware pin, reset factory setting, read out error memory, generate report
Code type	Gray
Code sequence parameter adjustable	CW/CCW configurable ²⁾
Clock frequency	100 kHz, ≤ 1 MHz
Set (electronic adjustment)	H-active (L = 0 - 1,5 V, H = 2,0 - Us V)
CW/CCW (counting sequence when turning)	L-active (L = 0 - 1,5 V, H = 2,0 - Us V)
Sine/cosine periods per revolution	1,024
Output frequency	≤ 153.6 kHz
Load resistance	≥ 120 Ω
Signal before differential generation	0.5 V _{pp} , ± 20 %
Signal offset before differential generation	2.5 V ± 10 %
Signal after differential generation	1 V _{pp} , ± 20 %

¹⁾ Valid signals can be read once this time has elapsed.

²⁾ Set on tool side: CW with view to the shaft.

Electrical data

Connection type	Male connector, M12, 12-pin, radial
Supply voltage	4.5 ... 30 V
Power consumption	0.7 W (without load)
Reverse polarity protection	✓
Short-circuit protection	✓ ¹⁾

¹⁾ SinCos interface: Short-circuit to another channel or GND permitted for max. 30 sec. In the case of U_S ≤ 12 V additional short-circuit to U_S permitted for max. 30 sec.

SSI interface: Short-circuit to another channel or GND permitted for max. 30 s. In the case of U_S ≤ 5 V, additional short-circuit to U_S permitted for max. 30 s.

Mechanical data

Mechanical design	Solid shaft, face mount flange
Shaft diameter	10 mm
Shaft length	19 mm
Weight	0.3 kg ¹⁾
Shaft material	Stainless steel
Flange material	Aluminum
Material, stator coupling	Stainless steel
Housing material	Aluminum die cast
Start up torque	≤ 0.5 Ncm (+20 °C)
Operating torque	≤ 0.3 Ncm (+20 °C)
Permissible shaft loading	80 N (radial) 40 N (axial)
Operating speed	≤ 9,000 min ⁻¹

¹⁾ Based on devices with male connector.

²⁾ Depending on the application, the operating life may also be limited by the bearing lifetime.

³⁾ The value corresponds to L_{10mr} (ISO/TS 16281) at 10 °C up to 60 °C operating temperature, speed > 10 U/min, at max. permitted shaft load / shaft movement.

Moment of inertia of the rotor	8 gcm ²
Bearing lifetime	3.6 x 10 ⁹ revolutions ^{2) 3)}
Angular acceleration	≤ 500,000 rad/s ²

¹⁾ Based on devices with male connector.

²⁾ Depending on the application, the operating life may also be limited by the bearing lifetime.

³⁾ The value corresponds to L_{10mr} (ISO/TS 16281) at 10 °C up to 60 °C operating temperature, speed > 10 U/min, at max. permitted shaft load / shaft movement.

Ambient data

EMC	EN 61000-6-2, EN 61000-6-3, EN 61000-6-7
Enclosure rating	IP65 (IEC 60529)
Permissible relative humidity	90 % (Condensation not permitted)
Operating temperature range	-30 °C ... +85 °C ¹⁾
Storage temperature range	-30 °C ... +85 °C, without package
Resistance to shocks	100 g, 6 ms (according to EN 60068-2-27) ²⁾
Resistance to vibration	30 g, 10 Hz ... 1,000 Hz (EN 60068-2-6) ²⁾
Operating height (above sea level)	≤ 2,000 m (80 kPa)
Protection class	III (according to DIN EN 61140)
Contamination rating	2 (IEC 60664-1)

¹⁾ At operating temperature measuring point.

²⁾ Tested during operation within the safety-related accuracy.

Classifications

eCl@ss 5.0	27270502
eCl@ss 5.1.4	27270502
eCl@ss 6.0	27270590
eCl@ss 6.2	27270590
eCl@ss 7.0	27270502
eCl@ss 8.0	27270502
eCl@ss 8.1	27270502
eCl@ss 9.0	27270502
eCl@ss 10.0	27270502
eCl@ss 11.0	27270502
eCl@ss 12.0	27270502
ETIM 5.0	EC001486
ETIM 6.0	EC001486
ETIM 7.0	EC001486
ETIM 8.0	EC001486
UNSPSC 16.0901	41112113

Dimensional drawing (Dimensions in mm (inch))

Solid shaft, face mount flange, M12 and M23 radial male connector

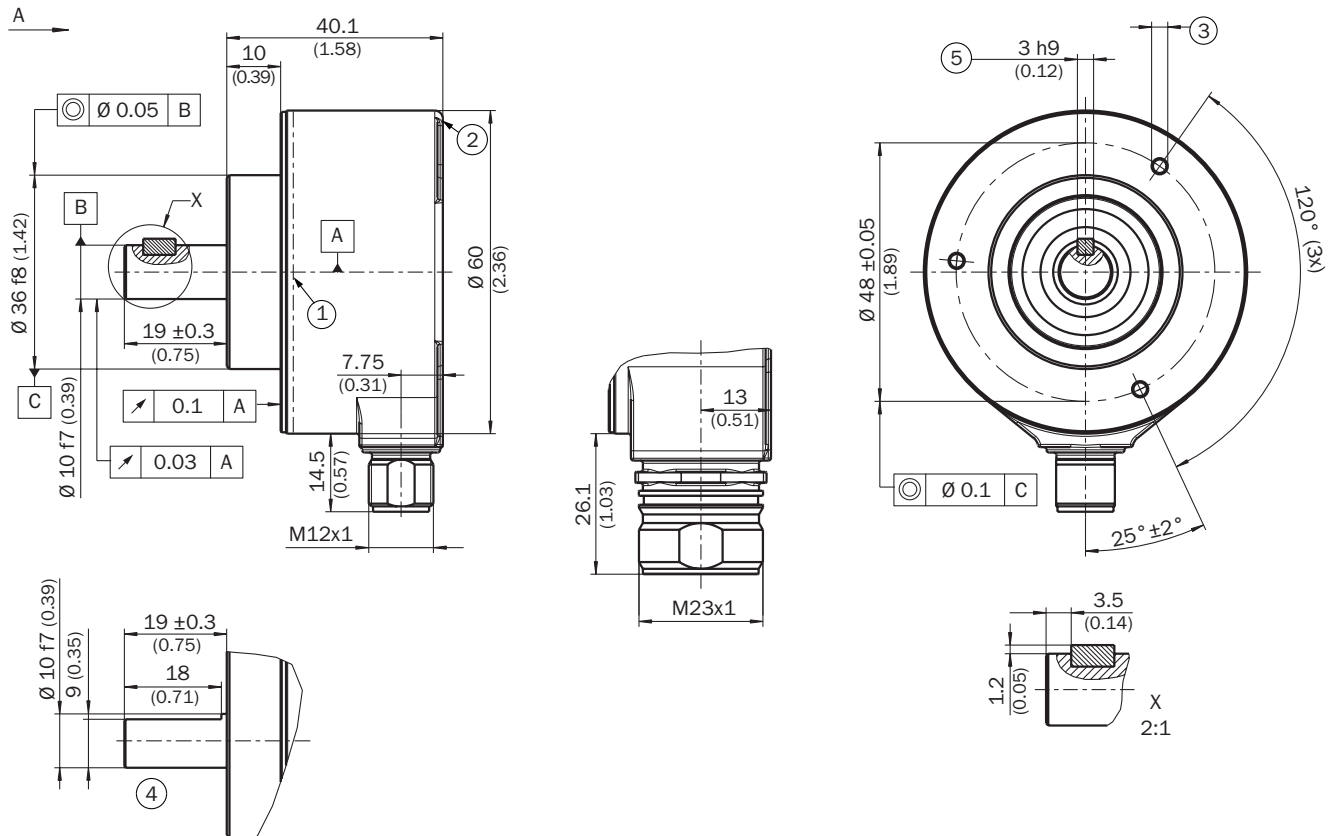

General tolerances according to DIN ISO 2768-mk

- ① Operating temperature measuring point (freely selectable, around the housing surface area in each case, approx. 3 mm away from flange)
- ② Measuring point vibration (respectively at the housing face. approx. 3 mm away from the cover edge)
- ③ M3 / M4 (3x) (6 mm deep)
- ④ Shaft with flat
- ⑤ Square key, DIN 6885-A 3x3x6

PIN assignment

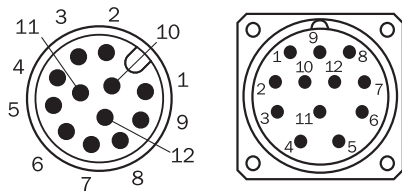

View of M23 and M12 male device connector on encoder

PIN (M23)	PIN (M12)	Wire colors (cable connection)	Signal	Explanation
1	5	Red	U _S	Operating voltage
2	12	Blue	GND	Ground connection
3	11	Yellow	Clock +	Interface signals
4	2	White	Data +	Interface signals
5	10	Orange	SET	Electronic adjustment

PIN (M23)	PIN (M12)	Wire colors (cable connection)	Signal	Explanation
6	3	Brown	Data -	Interface signals
7	4	Violet	Clock -	Interface signals
8	9	Black	- SIN	Signal cable
9	1	Orange-black	CW/CCW (V/R)	Sequence in direction of rotation
10	7	Green	- COS	Signal cable
11	6	Gray	+ COS	Signal cable
12	8	Pink	+ SIN	Signal cable
			Screen	Screen connected to housing on encoder side. Connected to ground on control side.

Diagrams

Signal SIN/COS before differential generation

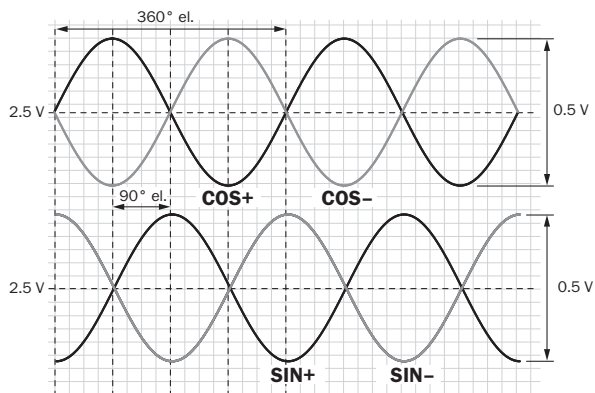

For clockwise shaft rotation, looking in direction "A" (see dimensional drawing)

Signal	Interface signals	Signal before differential generation At load 120 Ω	Signal offset
+ SIN - SIN + COS - COS	Analog, differential	0,5 V _{SS} ± 20 %	2,5 V ± 10 %

Signal SIN/COS after differential generation

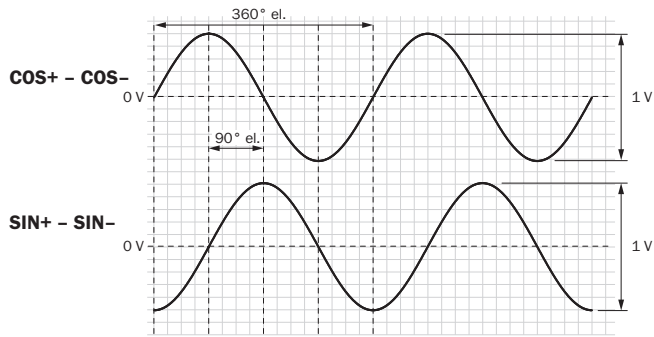



For clockwise shaft rotation, looking in direction "A" (see dimensional drawing)

Supply voltage	Output
4,5 V ... 5,5 V	Sin/Cos 1.0 V _{pp}

Recommended accessories

Other models and accessories → www.sick.com/AFS_AFM60S_Pro

	Brief description	Type	Part no.
Programming and configuration tools			
	USB programming unit, for programmable SICK encoders AFS60, AFM60, DFS60, VFS60, DFV60 and wire draw encoders with programmable encoders	PGT-08-S	1036616
Plug connectors and cables			
	Head A: female connector, M12, 12-pin, straight Head B: male connector, D-Sub, 9-pin, straight Cable: SSI + incremental, SSI + Sin/Cos, Incremental, shielded, 0.5 m Programming adapter cable for programming tool PGT-10-Pro and PGT-08-S	DSL-2D12-G0M5AC4	2088790

SICK AT A GLANCE

SICK is one of the leading manufacturers of intelligent sensors and sensor solutions for industrial applications. A unique range of products and services creates the perfect basis for controlling processes securely and efficiently, protecting individuals from accidents and preventing damage to the environment.

We have extensive experience in a wide range of industries and understand their processes and requirements. With intelligent sensors, we can deliver exactly what our customers need. In application centers in Europe, Asia and North America, system solutions are tested and optimized in accordance with customer specifications. All this makes us a reliable supplier and development partner.

Comprehensive services complete our offering: SICK LifeTime Services provide support throughout the machine life cycle and ensure safety and productivity.

For us, that is “Sensor Intelligence.”

WORLDWIDE PRESENCE:

Contacts and other locations –www.sick.com