



SEL37-HFA0-K02

SEK/SEL

MOTOR FEEDBACK SYSTEMS ROTARY HIPERFACE®

SICK
Sensor Intelligence.



Illustration may differ



Ordering information

| Type | Part no. |
|----------------|----------|
| SEL37-HFA0-K02 | 1037377 |

Other models and accessories → www.sick.com/SEK_SEL

Detailed technical data

Performance

| | |
|---------------------------------------------------------|-------------------------------------------------------------------------------------------------------------------|
| Sine/cosine periods per revolution | 16 |
| Number of the absolute ascertainable revolutions | 4,096 |
| Maximum number of steps per revolution | 512 via RS485 |
| Total number of steps | 2,097,152 |
| Measuring step | 20 " For interpolation of the sine/cosine signals with, e. g., 12 bits |
| Integral non-linearity | ± 288 ", Error limits for evaluating sine/cosine period Typical values at nominal position ± 0.1 mm und +20 °C |
| Differential non-linearity | ± 144 ", Non-linearity within a sine/cosine period, typical values at nominal position ± 0.1 mm und +20 °C |
| Operating speed | ≤ 6,000 min ⁻¹ , up to which the absolute position can be reliably produced |
| Available memory area | 1,792 Byte |
| System accuracy | ± 432 " |

Interfaces

| | |
|--------------------------------------------|-------------------------------------------------------------------------------------------------------------------------------------------------------------------------------------------------|
| Type of code for the absolute value | Binary |
| Code sequence | Increasing, when turning the shaft For clockwise rotation, looking in direction "A" (see dimensional drawing), For clockwise shaft rotation, looking in direction "A" (see dimensional drawing) |
| Communication interface | HIPERFACE® |

Electrical data

| | |
|---------------------------------------------|----------------------------------------|
| Connection type | Male connector, 8-pin, axial |
| Supply voltage | 7 V DC ... 12 V DC |
| Recommended supply voltage | 8 V DC |
| Current consumption | < 50 mA ¹⁾ |
| MTTF: mean time to dangerous failure | 275 years (EN ISO 13849) ²⁾ |

¹⁾ Without load.

²⁾ This product is a standard product and does not constitute a safety component as defined in the Machinery Directive. Calculation based on nominal load of components, average ambient temperature 60 °C, frequency of use 8760 h/a. All electronic failures are considered hazardous. For more information, see document no. 8015532.

Mechanical data

| | |
|------------------------------------------|-----------------------------------------|
| Shaft version | Tapered shaft |
| Dimensions | See dimensional drawing |
| Weight | ≤ 0.05 kg |
| Moment of inertia of the rotor | 1 gcm ² |
| Operating speed | 12,000 min ⁻¹ , 12,000 U/min |
| Angular acceleration | ≤ 500,000 rad/s ² |
| Permissible radial shaft movement | ± 0.15 mm |
| Permissible axial shaft movement | ± 0.3 mm |

Ambient data

| | |
|----------------------------------------------------|-------------------------------------------------------------------------------------|
| Operating temperature range | -20 °C ... +115 °C |
| Storage temperature range | -50 °C ... +125 °C, without package |
| Relative humidity/condensation | 90 %, Condensation not permitted |
| Resistance to shocks | 100 g, 10 ms (according to EN 60068-2-27) |
| Frequency range of resistance to vibrations | 50 g, 10 Hz ... 2,000 Hz (EN 60068-2-6) |
| EMC | According to EN 61000-6-2 and EN 61000-6-3 ¹⁾ |
| Enclosure rating | IP40, built-on version, with mating connector inserted and closed cover (IEC 60529) |

¹⁾ The EMC according to the standards quoted is achieved when the motor feedback system is mounted in an electrically conductive housing, which is connected to the central earthing point of the motor controller via a cable screen. If other shielding concepts are used, users must perform their own tests.

Classifications

| | |
|-----------------------|----------|
| eCl@ss 5.0 | 27270590 |
| eCl@ss 5.1.4 | 27270590 |
| eCl@ss 6.0 | 27270590 |
| eCl@ss 6.2 | 27270590 |
| eCl@ss 7.0 | 27270590 |
| eCl@ss 8.0 | 27270590 |
| eCl@ss 8.1 | 27270590 |
| eCl@ss 9.0 | 27270590 |
| eCl@ss 10.0 | 27273805 |
| eCl@ss 11.0 | 27273901 |
| eCl@ss 12.0 | 27273901 |
| ETIM 5.0 | EC001486 |
| ETIM 6.0 | EC001486 |
| ETIM 7.0 | EC001486 |
| ETIM 8.0 | EC001486 |
| UNSPSC 16.0901 | 41112113 |

Dimensional drawing (Dimensions in mm (inch))

General tolerances according to DIN ISO 2768-mk

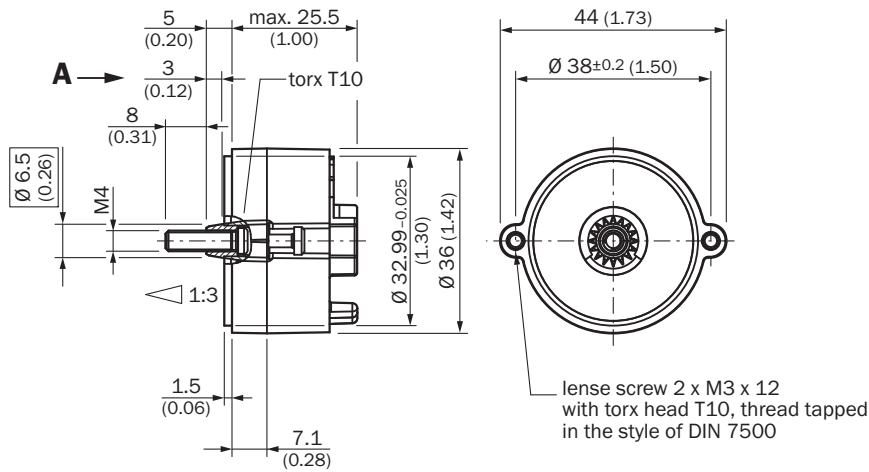

Axial

Attachment specifications

General tolerances according to DIN ISO 2768-mk

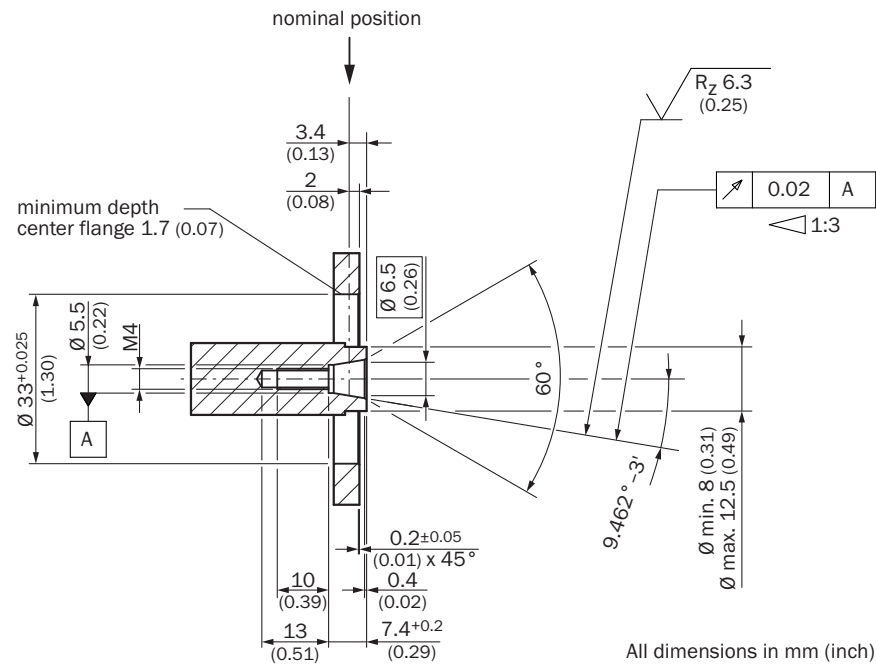

Axial

PIN assignment

View of the plug-in face

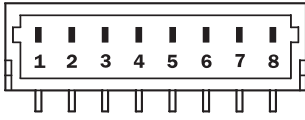

| PIN | Signal | Wire colors (cable connection) | Explanation |
|-----|----------------|--------------------------------|--------------------------|
| 1 | U _S | Red | Supply voltage |
| 2 | + SIN | White | Process data channel |
| 3 | REFSIN | Brown | Process data channel |
| 4 | + COS | Pink | Process data channel |
| 5 | REFCOS | Black | Process data channel |
| 6 | GND | Blue | Ground connection |
| 7 | Data + | Gray or yellow | Parameter channel RS 485 |
| 8 | Data - | Green or purple | Parameter channel RS 485 |

The GND connection (0 V) of the supply voltage is not connected to the housing

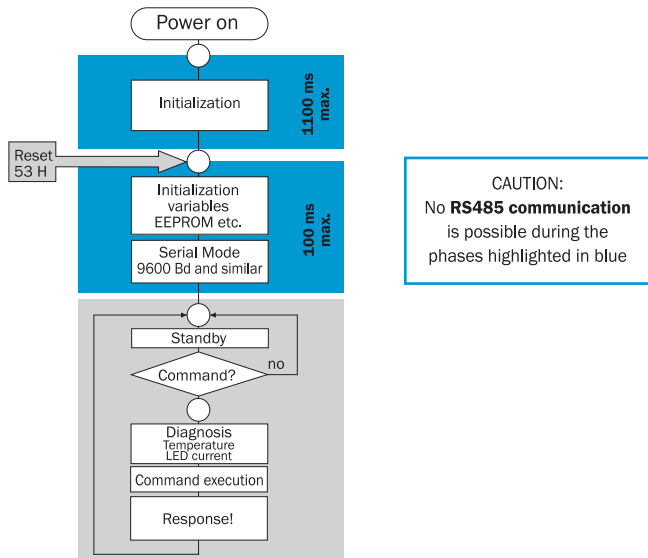
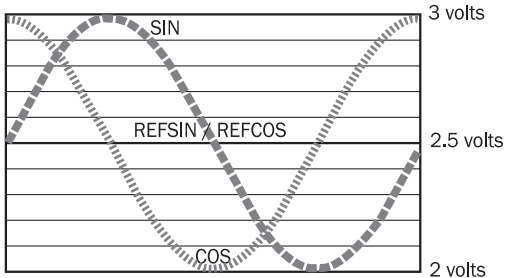

Diagrams

Signal diagram for clockwise shaft rotation, looking in direction "A" (see dimensional drawing) 1 period = 360° : 16



Recommended accessories

Other models and accessories → www.sick.com/SEK_SEL

| | Brief description | Type | Part no. |
|-----------------------------------------------------------------------------------|-----------------------------------------------------------------------------------------------------|------------------|----------|
| Plug connectors and cables | | | |
| | Head A: cable Head B: Flying leads Cable: HIPERFACE®, HIPERFACE®, PUR, halogen-free, shielded | LTG-2708-MW | 6028361 |
|  |  | DOL-0J08-G0M2XB6 | 2031086 |

SICK AT A GLANCE

SICK is one of the leading manufacturers of intelligent sensors and sensor solutions for industrial applications. A unique range of products and services creates the perfect basis for controlling processes securely and efficiently, protecting individuals from accidents and preventing damage to the environment.

We have extensive experience in a wide range of industries and understand their processes and requirements. With intelligent sensors, we can deliver exactly what our customers need. In application centers in Europe, Asia and North America, system solutions are tested and optimized in accordance with customer specifications. All this makes us a reliable supplier and development partner.

Comprehensive services complete our offering: SICK LifeTime Services provide support throughout the machine life cycle and ensure safety and productivity.

For us, that is “Sensor Intelligence.”

WORLDWIDE PRESENCE:

Contacts and other locations –www.sick.com