



WL2SG-2P3235S07

W2

MINIATURE PHOTOELECTRIC SENSORS

SICK
Sensor Intelligence.



Ordering information

Type	Part no.
WL2SG-2P3235S07	1104588

Other models and accessories → www.sick.com/W2

Illustration may differ



Detailed technical data

Features

Functional principle	Photoelectric retro-reflective sensor
Functional principle detail	Autocollimation
Dimensions (W x H x D)	7.7 mm x 21.8 mm x 13.5 mm
Housing design (light emission)	Rectangular
Sensing range max.	0 m ... 1.2 m ¹⁾
Sensing range	0 m ... 0.55 m ¹⁾
Type of light	Visible red light
Light source	PinPoint LED ²⁾
Light spot size (distance)	Ø 12 mm (250 mm)
Wave length	640 nm
Adjustment	Cable
AutoAdapt	✓
Special applications	Detecting transparent objects

¹⁾ Reflector P250F.

²⁾ Average service life: 100,000 h at T_U = +25 °C.

Mechanics/electronics

Supply voltage U_B	10 V DC ... 30 V DC ¹⁾
Ripple	< 5 V _{pp} ²⁾
Current consumption	20 mA ³⁾
Switching output	PNP
Switching mode	Light switching
Output current I_{max}	≤ 50 mA
Response time	< 0.5 ms ⁴⁾
Switching frequency	1,000 Hz ⁵⁾
Connection type	Cable with M8 male connector, 4-pin, 350 mm ⁶⁾
Cable material	PVC
Conductor cross section	0.09 mm ²
Cable diameter	Ø 3 mm
Circuit protection	A ⁷⁾ B ⁸⁾ D ⁹⁾
Polarisation filter	✓
Housing material	Plastic, ABS/PC
Optics material	Plastic, PMMA
Enclosure rating	IP67
Ambient operating temperature	-20 °C ... +50 °C
Ambient temperature, storage	-40 °C ... +75 °C
UL File No.	NRKH.E181493

¹⁾ Limit values.

²⁾ May not exceed or fall below U_V tolerances.

³⁾ Without load.

⁴⁾ Signal transit time with resistive load.

⁵⁾ With light/dark ratio 1:1.

⁶⁾ Do not bend below 0 °C.

⁷⁾ A = V_S connections reverse-polarity protected.

⁸⁾ B = output reverse-polarity protected.

⁹⁾ D = outputs overcurrent and short-circuit protected.

Safety-related parameters

MTTF_D	1,987 years
DC_{avg}	0 %

Classifications

ECLASS 5.0	27270902
ECLASS 5.1.4	27270902
ECLASS 6.0	27270902
ECLASS 6.2	27270902
ECLASS 7.0	27270902
ECLASS 8.0	27270902

ECLASS 8.1	27270902
ECLASS 9.0	27270902
ECLASS 10.0	27270902
ECLASS 11.0	27270902
ECLASS 12.0	27270902
ETIM 5.0	EC002717
ETIM 6.0	EC002717
ETIM 7.0	EC002717
ETIM 8.0	EC002717
UNSPSC 16.0901	39121528

Connection diagram

Cd-092

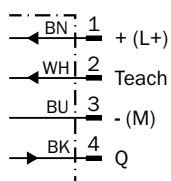

Characteristic curve

WL2S-2

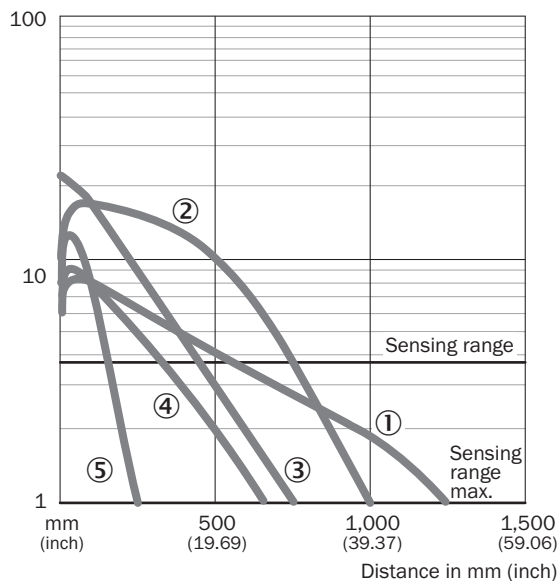

- ① Reflector P250F
- ② Reflector PL20F
- ③ Reflective tape REF-AC1000
- ④ PL10F reflector
- ⑤ Reflector PL8FH

Light spot size

WL2S-2

Spot diameter in mm (inch)

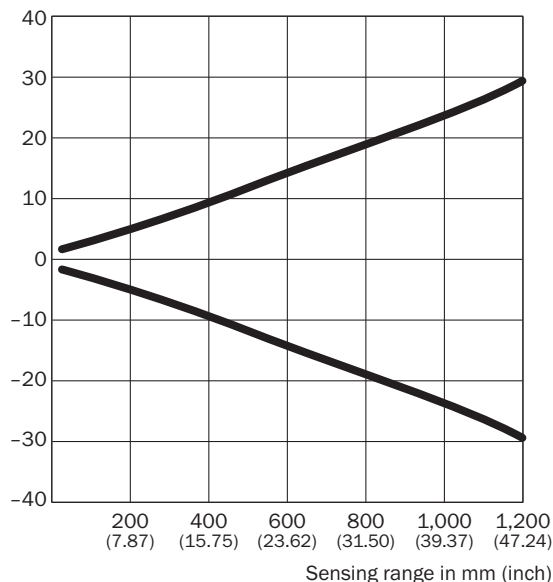

Dimensions in mm (inch)

Sensing range	Spot diameter
20 (0.79)	3.4 (0.13)
100 (3.94)	6.5 (0.26)
250 (9.84)	12.0 (0.47)
500 (19.69)	34.0 (1.34)
1,000 (39.37)	48.0 (1.89)
1,200 (47.24)	60.0 (2.36)

Sensing range diagram

WL2S-2

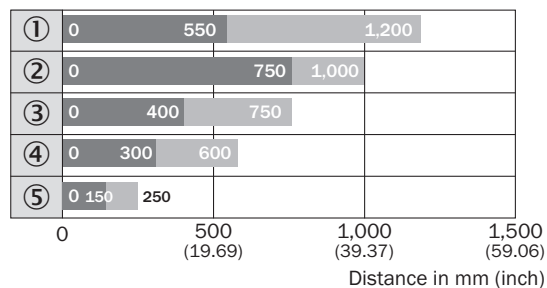

■ Sensing range ■ Sensing range max.

- ① Reflector P250F
- ② Reflector PL20F
- ③ Reflective tape REF-AC1000
- ④ PL10F reflector
- ⑤ Reflector PL8FH

Dimensional drawing (Dimensions in mm (inch))

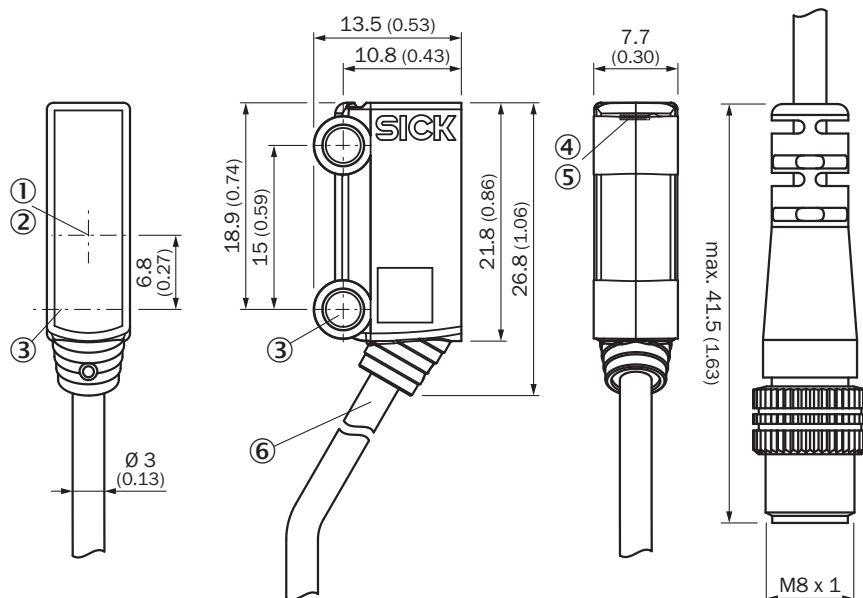

WL2S-2



- ① Optical axis, receiver
- ② Optical axis, sender
- ③ Middle axis fixing hole \varnothing 3.2 mm
- ④ LED indicator green: Supply voltage active
- ⑤ LED indicator yellow: Status of received light beam
- ⑥ Connection

Recommended accessories

Other models and accessories → www.sick.com/W2

	Brief description	Type	Part no.
Plug connectors and cables			
	<ul style="list-style-type: none"> • Connection type head A: Female connector, M8, 4-pin, straight, A-coded • Connection type head B: Flying leads • Signal type: Sensor/actuator cable • Cable: 5 m, 4-wire, PVC • Description: Sensor/actuator cable, unshielded • Application: Zones with chemicals 	YF8U14-050VA3XLEAX	2095889
	<ul style="list-style-type: none"> • Connection type head A: Male connector, M8, 4-pin, straight • Description: Unshielded • Connection systems: Screw-type terminals • Permitted cross-section: 0.14 mm² ... 0.5 mm² 	STE-0804-G	6037323
Reflectors			
	Fine triple reflector, screw connection, suitable for laser sensors, 20 mm x 32 mm, PM-MA/ABS, Screw-on, 2 hole mounting	PL10F	5311210

SICK AT A GLANCE

SICK is one of the leading manufacturers of intelligent sensors and sensor solutions for industrial applications. A unique range of products and services creates the perfect basis for controlling processes securely and efficiently, protecting individuals from accidents and preventing damage to the environment.

We have extensive experience in a wide range of industries and understand their processes and requirements. With intelligent sensors, we can deliver exactly what our customers need. In application centers in Europe, Asia and North America, system solutions are tested and optimized in accordance with customer specifications. All this makes us a reliable supplier and development partner.

Comprehensive services complete our offering: SICK LifeTime Services provide support throughout the machine life cycle and ensure safety and productivity.

For us, that is “Sensor Intelligence.”

WORLDWIDE PRESENCE:

Contacts and other locations –www.sick.com