

BY-W

Embouts roulés brasés

Domaine d'application : Industrie

Description :

- Matière : Cuivre étamé.
- Fût roulé brasé.

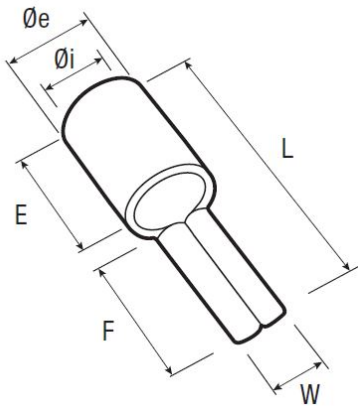

Section câble (mm ²)	Code article	Réf.	Conditionnement	W	F	L	E	Ø i	Ø e	Type matrice
6 - 10	7380450	BY10W13D	100	4,3	14	22	8	4,5	6,9	..DMB10

