

Product designation				Rotary cam switches
Product type designation				7GN40
<b>General characteristics</b>				
Switching diagram				07 - ON/OFF switch 3 poles
N° of elements				2
Mounting form				U25 - Front mounting with red/yellow handle padlockable in 0 and protection covers
<b>Contact characteristics</b>				
Rated insulation voltage $U_i$	IEC/EN	V	690	
	UL/CSA	V	600	
Rated impulse withstand voltage $U_{imp}$		kV	6	
Conventional free air thermal current $I_{th}$	IEC/EN	A	40	
	UL/CSA	A	50	
Rated operational voltage		V	480	
Rated operational impulse voltage		kV	4	
Maximum fuse size for short-circuit protection $I_n$ (gG)	10kA	A	40	
	15kA	A	40	
	25kA	A	40	
	50kA	A	40	
	63kA	A	40	
Rated short time current $I_{cw}$	1s	A	1000	
Conductivity				10/5 mA/V
Operational current $I_e$ IEC/EN				
AC1/AC21A		A	40	
AC15	110V	A	25	
	220/230V	A	22	
	380/400V	A	12	
	660/690V	A	2	
Rated operational power in AC				
Three-phase AC-3	220/230V	kW	8	
	380/440V	kW	15	
	500/690V	kW	15	
Single-phase AC-3	110V	kW	3	
	220/230V	kW	6.5	
	380/440V	kW	8	
Three-phase AC23A	220/230V	kW	8	
	380/440V	kW	18.5	
	500/690V	kW	22	

Single-phase AC23A			
	110V	kW	3
	220/230V	kW	6
	380/440V	kW	11
Rated operational current in DC			
DC21A			
	48V	A	40
	60V	A	40
	110V	A	6
	220V	A	0.9
DC23A (poles in series)			
	24V	A	40 (1)
	48V	A	40 (2)
	60V	A	40 (3)
	110V	A	20 (3)
	220V	A	12 (4)
DC13			
	24V	A	40
	48V	A	32
	60V	A	16
	110V	A	3
Power dissipation		W	2.0
<b>Mechanical features</b>			
Terminals screw			M4
Tightening torque for terminals max		Nm	1.2
Conductor size			
AWG - Rigid cable			
	min	AWG	16
	Max	AWG	8
AWG - Flexible cable			
	min	AWG	16
	Max	AWG	10
Conductor size (IEC) - Flexible cable			
	min	mm <sup>2</sup>	1.5
	Max	mm <sup>2</sup>	6
Conductor size (IEC) - Rigid cable			
	min	mm <sup>2</sup>	1.5
	Max	mm <sup>2</sup>	10
Mechanical life		cycles	5x10 <sup>6</sup>
<b>UL technical data</b>			
Motor power for direct-on-line control			
for three-phase motor			
	120V	HP	5
	240V	HP	10
	480V	HP	20
	600V	HP	20
for single-phase motor			
	120V	HP	2
	240V	HP	5
<b>Ambient conditions</b>			
Temperature			
Operating temperature			
	min	°C	-25
	max	°C	+55

Storage temperature

min °C -40  
max °C +70

**Resistance & Protection**

Frontal IP degree IP40  
Terminals IP degree IP00

**Dimensions**

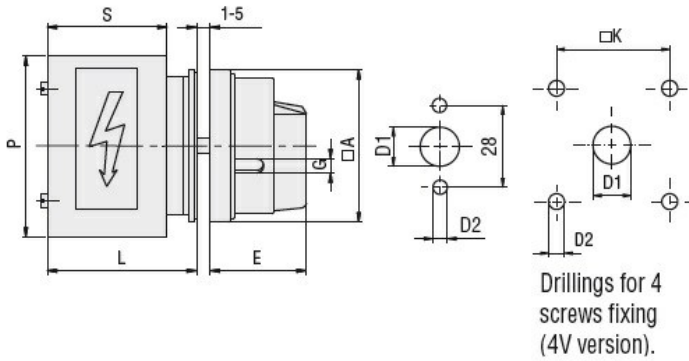

Series	Dimensions								
	□A	D1	D2	E	G	□K	S	P	L
7GN12	65	12	5	34.2	5	36	43	64	54.3
7GN20	65	12	5	34.2	5	36	43	64	54.3
7GN25	65	12	5	34.2	5	36	51	68	62.6
7GN32	65	14	5	38	6	48	55	77	71.7
7GN40	65	14	5	38	6	48	55	77	71.7

**Wiring diagrams**

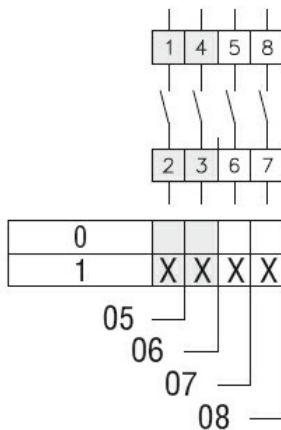

**Certifications and compliance**

Compliance

CSA C22.2 n° 14  
IEC/EN/BS 60947-1  
IEC/EN/BS 60947-3  
IEC/EN/BS 60947-5-1  
UL60947-4-1

Certificates

cCSAus  
EAC  
UL

**ETIM classification**

ETIM 8.0

EC001029 -  
Selector switch,  
complete