



Product designation				Power contactor
Product type designation				BFK95
Contact characteristics				
Number of poles	Nr.			3
Rated insulation voltage U_i IEC/EN	V			690
Rated impulse withstand voltage U_{imp}	kV			8
Operational frequency	min	Hz	25	
	max	Hz	400	
IEC Conventional free air thermal current I_{th}	A			140
Rated operational power AC-6b ($T \leq 40^\circ C$)	230V	kvar	34	
	400V	kvar	60	
	440...480V	kvar	75	
	690V	kvar	80	
Short-time allowable current for 10s (IEC/EN60947-1)	A			760
Protection fuse	gG (IEC)	A	125	
		A	1200	
Making capacity (RMS value)				1200
Breaking capacity at voltage	440V	A	1100	
	500V	A	775	
	690V	A	745	
		m Ω	0.45	
Resistance per pole (average value)				0.45
Power dissipation per pole (average value)	I_{th}	W	8.8	
Tightening torque for terminals	min	Nm	6	
	max	Nm	7	
	min	Ibin	4.4	
	max	Ibin	5.2	
Tightening torque for coil terminal	min	Nm	0.8	
	max	Nm	1	
	min	Ibin	0.59	
	max	Ibin	0.74	
Max number of wires simultaneously connectable	Nr.			2
Conductor section	AWG/Kcmil			
	max			2/0
Flexible w/o lug conductor section	min	mm ²	1.5	
	max	mm ²	70	
Flexible c/w lug conductor section	min	mm ²	1.5	

		max	mm ²	70
Power terminal protection according to IEC/EN 60529				IP20 front
Mechanical features				
Operating position		normal allowable		Vertical plan ±30°
Fixing				Screw / DIN rail 35mm
Weight			g	2095
Conductor section	AWG/kcmil conductor section	max		2/0
Operations				
Mechanical life			cycles	15000000
Electrical life			cycles	400000
Safety related data				
Performance level B10d according to EN/ISO 13489-1		rated load mechanical load	cycles cycles	400000 15000000
EMC compatibility				yes
AC coil operating				
Rated AC voltage at 50/60Hz			V	24
AC operating voltage	of 50/60Hz coil powered at 50Hz			
	pick-up	min	%Us	80
		max	%Us	110
	drop-out	min	%Us	20
		max	%Us	55
	of 50/60Hz coil powered at 60Hz			
	pick-up	min	%Us	85
		max	%Us	110
	drop-out	min	%Us	40
		max	%Us	55
AC average coil consumption at 20°C	of 50/60Hz coil powered at 50Hz	holding	VA	20
	of 50/60Hz coil powered at 60Hz	in-rush	VA	300
		holding	VA	17
	of 60Hz coil powered at 60Hz	in-rush	VA	300
		holding	VA	20
Dissipation at holding ≤20°C 50Hz			W	6.5
Max cycles frequency				
Mechanical operation			cycles/h	1500
Operating times				
Average time for Us control in AC	Closing NO	min	ms	16

Opening NO	max	ms	32
	min	ms	9
	max	ms	24

UL technical data

General USE

Contactor

AC current A 140

Ambient conditions

Temperature

Operating temperature

min °C -50
max °C 70

Storage temperature

min °C -60
max °C 80

Max altitude

m 3000

Resistance & Protection

Pollution degree

3

Dimensions

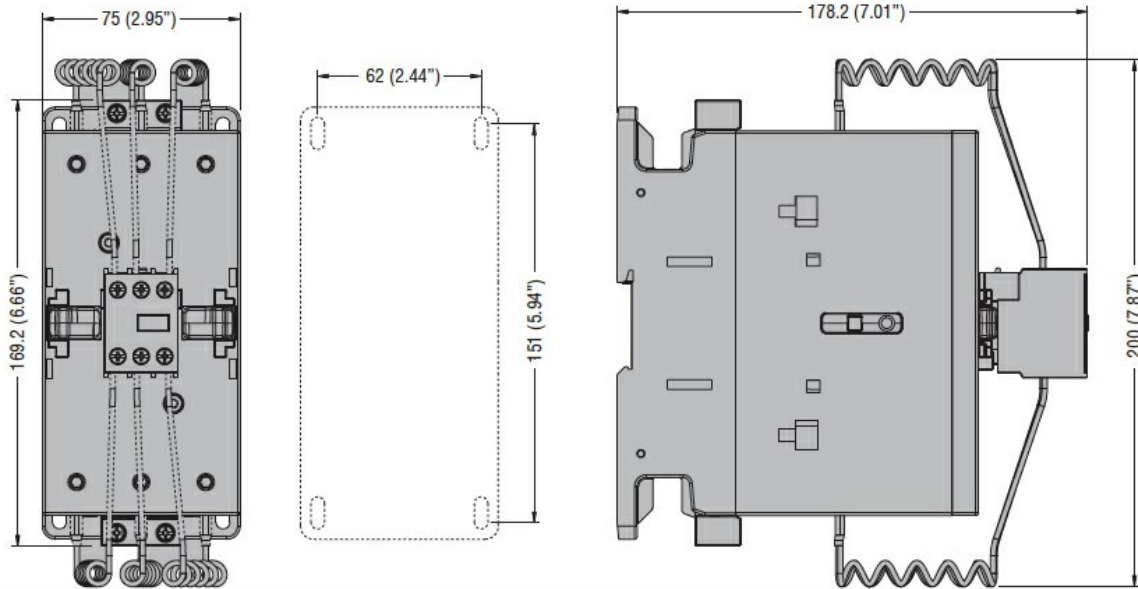

Wiring diagrams

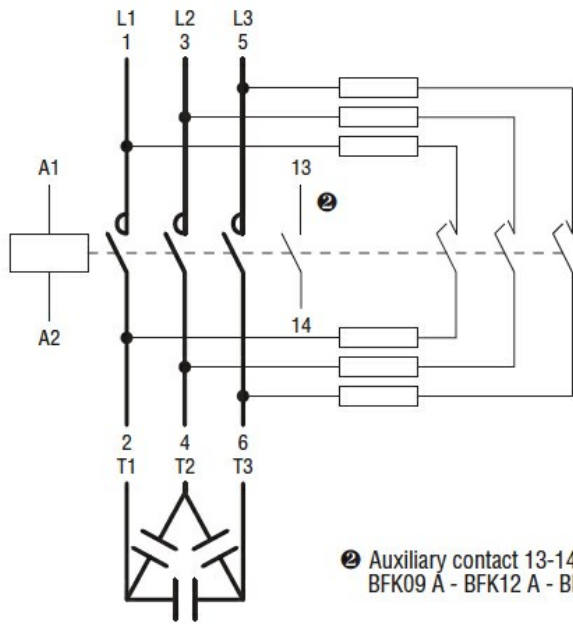

Ⓜ Auxiliary contact 13-14 is found on BFK09 A - BFK12 A - BFK18 A types only.

Certifications and compliance

Compliance

CSA C22.2 n° 60947-1

CSA C22.2 n° 60947-4-1

IEC/EN/BS 60947-1

IEC/EN/BS 60947-4-1

UL 60947-1

UL 60947-4-1

Certificates

CCC

cULus

ETIM classification

ETIM 8.0

EC001079 -
Capacitor
contactor