



# WL4SLGC-3P2252A71

W4

MINIATURE PHOTOELECTRIC SENSORS

**SICK**  
Sensor Intelligence.



Illustration may differ

## Ordering information

Type	Part no.
WL4SLGC-3P2252A71	1080955

The sensor is equipped with a special Smart Task function. Additional information can be found in the "Technical Data." Use of the sensor for pure object detection is limited.

Other models and accessories → [www.sick.com/W4](http://www.sick.com/W4)



## Detailed technical data

### Features

<b>Functional principle</b>	Photoelectric retro-reflective sensor
<b>Functional principle detail</b>	Autocollimation
<b>Sensing range max.</b>	0 m ... 3.5 m <sup>1) 2)</sup>
<b>Sensing range</b>	0 m ... 2.2 m <sup>1) 2)</sup>
<b>Polarisation filters</b>	Yes
<b>Emitted beam</b>	
Light source	Laser <sup>3)</sup>
Type of light	Visible red light
Light spot size (distance)	Ø 0.4 mm (60 mm)
<b>Key laser figures</b>	
Normative reference	EN 60825-1:2014, IEC 60825-1:2014 / CDRH 21 CFR 1040.10 & 1040.11
Laser class	1
Wave length	650 nm
<b>Adjustment</b>	IO-Link, Single teach-in button

<sup>1)</sup> Reflective tape REF-AC1000.

<sup>2)</sup> To ensure reliable operation, we recommend using REF-AC1000 reflective tape or reflective-tap reflectors such as P41F, PLV14-A, PLH25-M12, or PLH25-D12. Reflectors with large-scale triple structures must only be used if deemed suitable for the application.

<sup>3)</sup> Average service life: 50,000 h at T<sub>U</sub> = +25 °C.

<b>Special applications</b>	Detecting transparent objects, Detecting small objects
<b>Mounting hole</b>	M3
<b>Pin 2 configuration</b>	External input, Teach-in input, Sender off input, Detection output, logic output, Device contamination alarm output
<b>AutoAdapt</b>	✓

<sup>1)</sup> Reflective tape REF-AC1000.

<sup>2)</sup> To ensure reliable operation, we recommend using REF-AC1000 reflective tape or reflective-tap reflectors such as P41F, PLV14-A, PLH25-M12, or PLH25-D12. Reflectors with large-scale triple structures must only be used if deemed suitable for the application.

<sup>3)</sup> Average service life: 50,000 h at  $T_J = +25\text{ °C}$ .

## Safety-related parameters

<b>MTTF<sub>D</sub></b>	562 years (EN ISO 13849-1) <sup>1)</sup>
<b>DC<sub>avg</sub></b>	0 %
<b>T<sub>M</sub> (mission time)</b>	10 years

<sup>1)</sup> Mode of calculation: Parts-Count-calculation.

## Communication interface

<b>IO-Link</b>	✓, COM2 (38,4 kBaud)
Data transmission rate	COM2 (38,4 kBaud)
Cycle time	2.3 ms
Process data length	16 Bit
Process data structure	Bit 0 = switching signal Q <sub>L1</sub> Bit 1 = switching signal Q <sub>L2</sub> Bit 2 ... 15 = measuring value
VendorID	26
DeviceID HEX	0x800119
DeviceID DEC	8388889

## Electrical data

<b>Supply voltage U<sub>B</sub></b>	10 V DC ... 30 V DC <sup>1)</sup>
<b>Ripple</b>	< 5 V <sub>pp</sub> <sup>2)</sup>
<b>Current consumption</b>	30 mA <sup>3)</sup>
<b>Protection class</b>	III
<b>Digital output</b>	
Type	PNP <sup>4) 5)</sup>
Switching mode	Light/dark switching <sup>4)</sup>

<sup>1)</sup> Limit values when operated in short-circuit protected network: max. 8 A.

<sup>2)</sup> May not exceed or fall below U<sub>v</sub> tolerances.

<sup>3)</sup> Without load.

<sup>4)</sup> Q = light switching.

<sup>5)</sup> Pin 4: This switching output must not be connected to another output.

<sup>6)</sup> Signal transit time with resistive load.

<sup>7)</sup> Valid for Q \ on Pin2, if configured with software.

<sup>8)</sup> With light/dark ratio 1:1.

<sup>9)</sup> A = V<sub>S</sub> connections reverse-polarity protected.

<sup>10)</sup> B = inputs and output reverse-polarity protected.

<sup>11)</sup> C = interference suppression.

<sup>12)</sup> With light / dark ratio 1:1, valid for Q \ on Pin2, if configured with software.

Output current $I_{\max}$	$\leq 100$ mA
Response time	$\leq 0.5$ ms <sup>6)</sup>
Repeatability (response time)	$150$ $\mu$ s <sup>7)</sup>
Switching frequency	$1,000$ Hz <sup>8)</sup>
<b>Output function</b>	Complementary
<b>Circuit protection</b>	A <sup>9)</sup> B <sup>10)</sup> C <sup>11)</sup>
<b>Response time Q/ on Pin 2</b>	$300$ $\mu$ s ... $450$ $\mu$ s <sup>6) 7)</sup>
<b>Switching frequency Q / to pin 2</b>	$1,000$ Hz <sup>12)</sup>

- 1) Limit values when operated in short-circuit protected network: max. 8 A.  
 2) May not exceed or fall below  $U_V$  tolerances.  
 3) Without load.  
 4) Q = light switching.  
 5) Pin 4: This switching output must not be connected to another output.  
 6) Signal transit time with resistive load.  
 7) Valid for Q \ on Pin2, if configured with software.  
 8) With light/dark ratio 1:1.  
 9) A =  $V_S$  connections reverse-polarity protected.  
 10) B = inputs and output reverse-polarity protected.  
 11) C = interference suppression.  
 12) With light / dark ratio 1:1, valid for Q \ on Pin2, if configured with software.

### Mechanical data

<b>Housing</b>	Rectangular
<b>Design detail</b>	Slim
<b>Dimensions (W x H x D)</b>	$12.2$ mm x $41.8$ mm x $17.3$ mm
<b>Connection</b>	Male connector M8, 4-pin
<b>Material</b>	
Housing	Plastic, Novodur
Front screen	Plastic, PMMA
<b>Weight</b>	$100$ g

### Ambient data

<b>Enclosure rating</b>	IP66 IP67
<b>Ambient operating temperature</b>	$-10$ °C ... $+50$ °C
<b>Ambient operating temperature extended</b>	$-30$ °C ... $+55$ °C <sup>1) 2)</sup>
<b>Ambient temperature, storage</b>	$-30$ °C ... $+70$ °C
<b>UL File No.</b>	NRKH.E181493
<b>RoHS certificate</b>	✓

- 1) As of  $T_a = 50$  °C, a max. supply voltage  $V_{\max} = 24$  V and a max. load current  $I_{\max} = 50$  mA is permitted.  
 2) Operation below  $T_u -10$  °C is possible if the sensor is already switched on at  $T_u > -10$  °C, then cools down, and the supply voltage is subsequently not switched off. Switching on below  $T_u -10$  °C is not permissible.

## Smart Task

<b>Smart Task name</b>	Counter + debouncing
<b>Logic function</b>	Direct WINDOW Hysteresis
<b>Timer function</b>	Deactivated On delay Off delay ON and OFF delay Impulse (one shot)
<b>Inverter</b>	Yes
<b>Maximum counting frequency</b>	SIO Direct: --- <sup>1)</sup> SIO Logic: 1000 Hz <sup>2)</sup> IOL: 900 Hz <sup>3)</sup>
<b>Counter reset</b>	SIO Direct: --- SIO Logic: 1,5 ms IOL: 1,5 ms
<b>Min. Time between two process events (switches)</b>	SIO Direct: --- SIO Logic: 450 µs IOL: 500 µs
<b>Debounce time max.</b>	SIO Direct: --- <sup>1)</sup> SIO Logic: 450 µs <sup>2)</sup> IOL: 500 µs <sup>3)</sup>
<b>Switching signal</b>	
Switching signal Q <sub>L1</sub>	Output type (dependant on the adjusted threshold)
Switching signal Q <sub>L2</sub>	Output type (dependant on the adjusted threshold)
<b>Measuring value</b>	Counting value

<sup>1)</sup> SIO Direct: sensor operation in standard I/O mode without IO-Link communication and without using internal sensor logic or time parameters (set to "direct"/"deactivated").

<sup>2)</sup> SIO Logic: Sensor operation in standard I/O mode without IO-Link communication. Sensor-internal logic or timing parameters plus Automation Functions used.

<sup>3)</sup> IOL: Sensor operation with full IO-Link communication and usage of logic, timing and Automation Function parameters.

## Diagnosis

<b>Device status</b>	Yes
<b>Quality of teach</b>	Yes
<b>Quality of run</b>	Yes, Contamination display

## Classifications

<b>ECLASS 5.0</b>	27270902
<b>ECLASS 5.1.4</b>	27270902
<b>ECLASS 6.0</b>	27270902
<b>ECLASS 6.2</b>	27270902
<b>ECLASS 7.0</b>	27270902
<b>ECLASS 8.0</b>	27270902
<b>ECLASS 8.1</b>	27270902
<b>ECLASS 9.0</b>	27270902
<b>ECLASS 10.0</b>	27270902
<b>ECLASS 11.0</b>	27270902
<b>ECLASS 12.0</b>	27270902

<b>ETIM 5.0</b>	EC002717
<b>ETIM 6.0</b>	EC002717
<b>ETIM 7.0</b>	EC002717
<b>ETIM 8.0</b>	EC002717
<b>UNSPSC 16.0901</b>	39121528

### Connection diagram

Cd-363

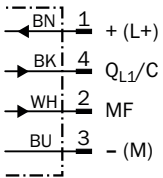

### Characteristic curve

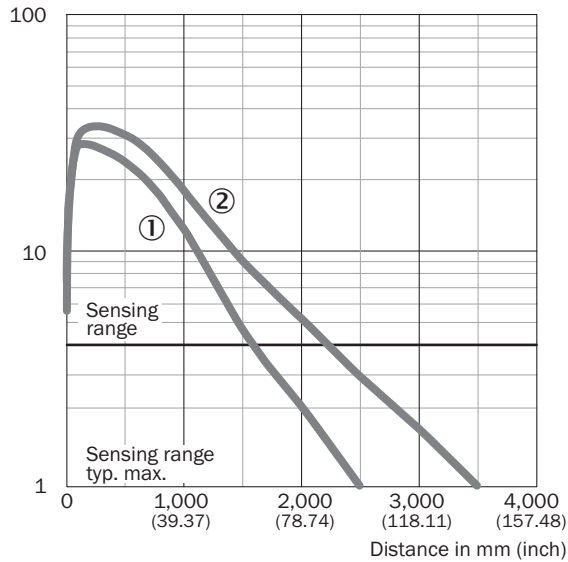

- ① Reflector PLV14-A / PLH25-M12 / PLH25-D12
- ② Reflector P41F / reflective tape REF-AC1000

**Light spot size**

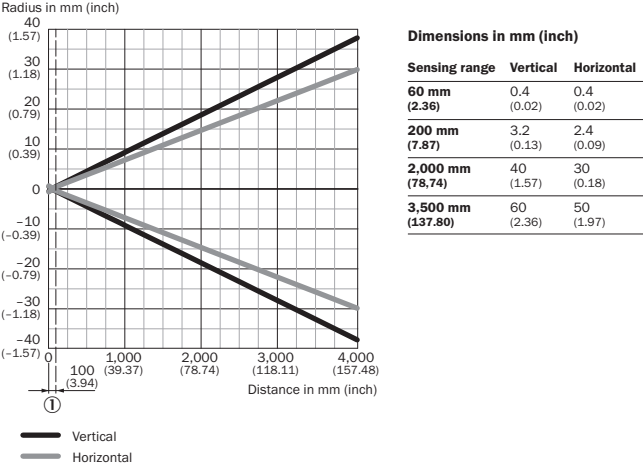

① Minimum distance between sensor and reflector

**Light spot size (detailed view)**

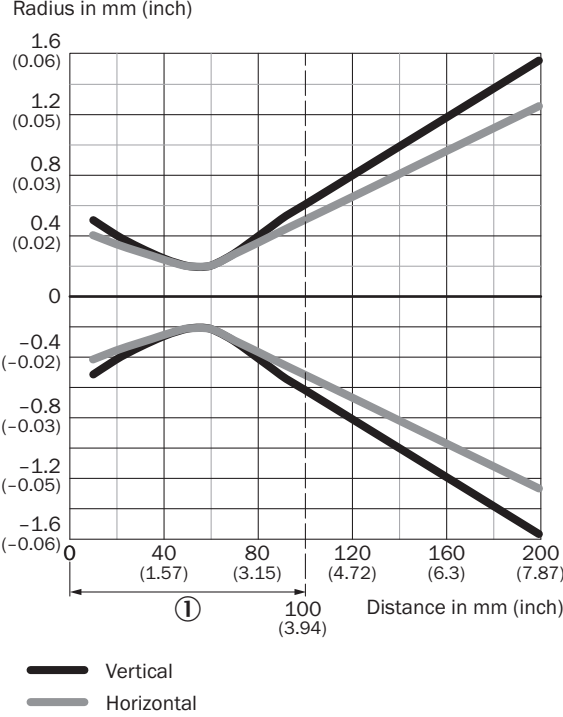

① Minimum distance between sensor and reflector

## Sensing range diagram

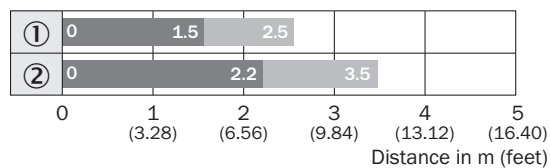

■ Sensing range    ■ Sensing range max.

① Reflector PLV14-A / PLH25-M12 / PLH25-D12

② Reflector P41F / reflective tape REF-AC1000

## Dimensional drawing (Dimensions in mm (inch))

WL4SL-3, WL4SLG-3, WSE4SL-3, plug

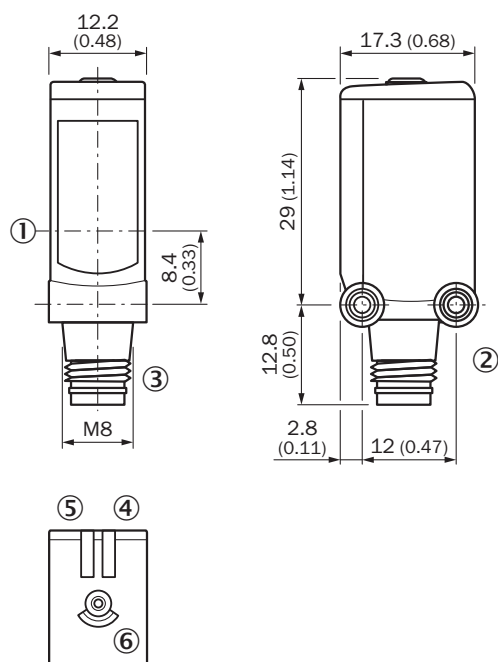

① Center of optical axis

② Threaded mounting hole M3

③ Connection

④ LED indicator green: Supply voltage active

⑤ LED indicator yellow: Status of received light beam





⑥ Single teach-in button

## Recommended accessories

Other models and accessories → [www.sick.com/W4](http://www.sick.com/W4)

	Brief description	Type	Part no.
Mounting brackets and plates			
	Mounting bracket for floor mounting, Stainless steel 1.4571, mounting hardware included	BEF-W4-B	2051630



	Brief description	Type	Part no.
	Universal mounting bracket for reflectors, steel, zinc coated	BEF-WN-REFX	2064574
Plug connectors and cables			
	<ul style="list-style-type: none"> <li>• <b>Connection type head A:</b> Male connector, M8, 4-pin, straight</li> <li>• <b>Description:</b> Unshielded</li> <li>• <b>Connection systems:</b> Screw-type terminals</li> <li>• <b>Permitted cross-section:</b> 0.14 mm<sup>2</sup> ... 0.5 mm<sup>2</sup></li> </ul>	STE-0804-G	6037323
Reflectors			
	Suitable for laser sensors, self-adhesive, cut, see alignment note, 56.3 mm x 56.3 mm, self-adhesive	REF-AC1000-56	4063030
Others			
	<ul style="list-style-type: none"> <li>• <b>Connection type head A:</b> Female connector, M8, 4-pin, straight, A-coded</li> <li>• <b>Connection type head B:</b> Flying leads</li> <li>• <b>Signal type:</b> Sensor/actuator cable</li> <li>• <b>Cable:</b> 5 m, 4-wire, PVC</li> <li>• <b>Description:</b> Sensor/actuator cable, unshielded</li> <li>• <b>Application:</b> Zones with chemicals</li> </ul>	YF8U14-050VA3XLEAX	2095889

## Recommended services

Additional services → [www.sick.com/W4](https://www.sick.com/W4)

	Type	Part no.
Function Block Factory		
<ul style="list-style-type: none"> <li>• <b>Description:</b> The Function Block Factory supports common programmable logic controllers (PLCs) from various manufacturers, such as Siemens, Beckhoff, Rockwell Automation and B&amp;R. More information on the FBF can be found <a _blank"="" href="https://fbf.cloud.sick.com target=">here</a>.</li> <li>• <b>Note:</b> You can configure your function block at <a _blank"="" href="https://fbf.cloud.sick.com target=">Function Block Factory</a>. As a login please use your SICK ID.</li> </ul>	Function Block Factory	On request

## SICK AT A GLANCE

SICK is one of the leading manufacturers of intelligent sensors and sensor solutions for industrial applications. A unique range of products and services creates the perfect basis for controlling processes securely and efficiently, protecting individuals from accidents and preventing damage to the environment.

We have extensive experience in a wide range of industries and understand their processes and requirements. With intelligent sensors, we can deliver exactly what our customers need. In application centers in Europe, Asia and North America, system solutions are tested and optimized in accordance with customer specifications. All this makes us a reliable supplier and development partner.

Comprehensive services complete our offering: SICK LifeTime Services provide support throughout the machine life cycle and ensure safety and productivity.

For us, that is “Sensor Intelligence.”

## WORLDWIDE PRESENCE:

Contacts and other locations –[www.sick.com](http://www.sick.com)